

**TUNG-SOL**

TWIN TRIODE

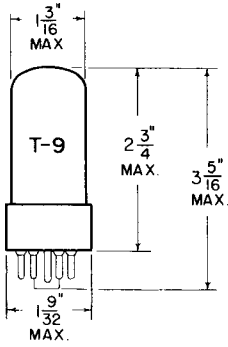

GLASS BULB

COATED UNIPOTENTIAL CATHODE

HEATER

6.3 VOLTS 0.6 AMP.

AC OR DC

ANY MOUNTING POSITION

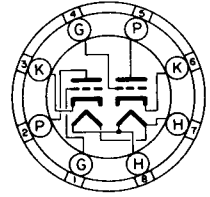

BOTTOM VIEW

INTERMEDIATE SHELL  
8 PIN OCTAL

680

THE 6SN7WGTA IS A RUGGEDIZED, MEDIUM MU, TWIN TRIODE IN THE OCTAL BASE, BANTAM CONSTRUCTION. THE TWO TRIODE SECTIONS ARE ELECTRICALLY INDEPENDENT, ALLOWING SIMULTANEOUS USE OF THE TWO IN COMPLETELY DIFFERENT APPLICATIONS. THE TYPE IS SUITABLE FOR A WIDE RANGE OF GENERAL PURPOSE APPLICATIONS SUCH AS OSCILLATORS, MULTIVIBRATORS, RESISTANCE-COUPLED VOLTAGE AMPLIFIER, ETC. CONTROLS ON THE PRODUCT AVERAGE FOR SUCH CHARACTERISTICS AS TRANSCONDUCTANCE ASSURE THAT THESE CRITICAL CHARACTERISTICS WILL REMAIN WELL CENTERED. SINCE IT MUST BE ABLE TO WITHSTAND SEVERE MECHANICAL TESTS TO MEET TEST SPECIFICATIONS, THE 6SN7WGTA IS ESPECIALLY SUITED FOR USE IN MILITARY AND INDUSTRIAL AIRBORNE EQUIPMENT WHICH MAY BE SUBJECTED TO SEVERE SHOCK AND VIBRATION.

DIRECT INTERELECTRODE CAPACITANCES

NO EXTERNAL SHIELD

	TRIODE #1	TRIODE #2	
GRID TO PLATE (RATED)	4.0	3.8	μμf
MAXIMUM	4.0	4.0	μμf
MINIMUM	3.0	3.0	μμf
INPUT (RATED)	2.2	2.6	μμf
MAXIMUM	2.7	2.7	μμf
MINIMUM	1.7	1.7	μμf
OUTPUT (RATED)	0.7	0.7	μμf
MAXIMUM	1.20	1.20	μμf
MINIMUM	0.60	0.60	μμf

CONTINUED ON FOLLOWING PAGE

PRINTED IN U. S. A.

**TUNG-SOL**

CONTINUED FROM PRECEDING PAGE

**RATINGS**

ABSOLUTE MAXIMUM VALUES

HEATER VOLTAGE	6.3±5%	VOLTS
MAXIMUM DC PLATE VOLTAGE	330	VOLTS
MAXIMUM PLATE DISSIPATION (PER PLATE)	3.44	WATTS
MAXIMUM GRID RESISTANCE	1.1	MEGOHMS
MAXIMUM HEATER-CATHODE VOLTAGE	2.5	VOLTS
MAXIMUM DC PLATE CURRENT (PER PLATE)	20.0	mA <sub>dc</sub>
MAXIMUM BULB TEMPERATURE	200	°C
MAXIMUM ALTITUDE	60 000	FEET

**TYPICAL OPERATING CONDITIONS AND CHARACTERISTICS**

CLASS A<sub>1</sub> AMPLIFIER

EACH UNIT

HEATER VOLTAGE	6.3	6.3	VOLTS
HEATER CURRENT	0.6	0.6	AMP.
PLATE VOLTAGE	90	250	VOLTS
GRID VOLTAGE	0	-8	VOLTS
PLATE CURRENT	10	9	mA.
AMPLIFICATION FACTOR	20	20	
PLATE RESISTANCE (APPROX.)	6 700	7 700	OHMS
TRANSCONDUCTANCE	3 000	2 600	μMHOS
PLATE CURRENT @ E <sub>c</sub> = -12.5 VOLTS	---	1.3	mA.
GRID VOLTAGE FOR I <sub>b</sub> = 10 μA (APPROX.)	-7.0	-18	VOLTS

CONTINUED ON FOLLOWING PAGE

**TUNG-SOL**

**RESISTANCE-COUPLED AMPLIFIER**

$R_L$ MEG.	$R_{g1}$ MEG.	$R_s$ MEG.	$E_{bb} = 90$ VOLTS			$E_{bb} = 180$ VOLTS			$E_{bb} = 300$ VOLTS		
			$R_k$	GAIN	$E_o$	$R_k$	GAIN	$E_o$	$R_k$	GAIN	$E_o$
0.10	A	0.10	3300	14	13	2200	14	26	1800	14	40
0.10	A	0.24	3600	14	16	2700	15	33	2200	15	51
0.24	A	0.24	7500	14	16	5100	15	30	4300	15	44
0.24	A	0.51	9100	14	19	6800	15	39	5100	15	54
0.51	A	0.51	13000	14	16	9100	15	30	6800	16	40
0.51	A	1.0	15000	14	19	10000	16	32	7500	16	45
0.24	10	0.24	0	25	13	0	16	33	0	17	46
0.24	10	0.51	0	16	17	0	17	38	0	18	62
0.51	10	0.51	0	16	14	0	18	32	0	18	53
0.51	10	1.0	0	17	18	0	18	41	0	19	68

A VALUE OF  $R_{g1}$  IS NOT CRITICAL.  
GAIN MEASURED AT  $E_o = 2.0$  VOLTS RMS OUTPUT.  
 $E_o$  IS RMS OUTPUT FOR 5% TOTAL HARMONIC DISTORTION.

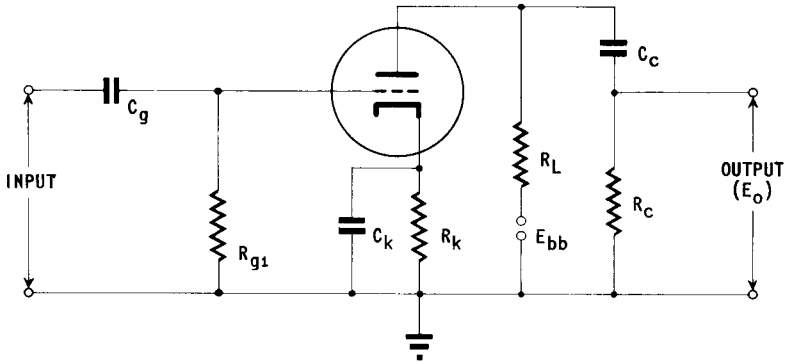

NOTE: COUPLING CAPACITORS  $C_g$  AND  $C_c$  SHOULD BE SELECTED TO GIVE DESIRED FREQUENCY RESPONSE.  $R_k$  SHOULD BE ADEQUATELY BY-PASSED BY CAPACITOR  $C_k$ .

CONTINUED ON FOLLOWING PAGE

PRINTED IN U. S. A.

**TUNG-SOL**

CONTINUED FROM PRECEDING PAGE

**CHARACTERISTICS RANGE VALUES FOR EQUIPMENT DESIGN**

$E_f=6.3V$ ,  $E_b=250Vdc$ ,  $E_c=-8Vdc$ ,  $E_{hk}=0$   
EXCEPT AS MODIFIED BELOW

	INITIAL				500 HOUR LIFE TEST		
	INDIVIDUAL MIN.	INDIVIDUAL MAX.	PROD. MIN.	AVG. MAX.	INDIVIDUAL MIN.	INDIVIDUAL MAX.	
HEATER CURRENT	550	650	---	---	550	650	mA.
HEATER-CATHODE LEAKAGE ( $E_{hk}=\pm 250 Vdc$ )	---	$\pm 25$	---	---	---	$\pm 25$	$\mu Adc$
INSULATION OF ELECTRODES <sup>B</sup> ( $E_f=6.3V$ .)							
E(g-ALL)	100	---	---	---	50	---	MEGOHMS
E(p-ALL)	100	---	---	---	50	---	MEGOHMS
GRID CURRENT <sup>A</sup>	0	-1.5	---	---	0	-1.5	$\mu Adc$
PLATE CURRENT (1)	5.5	12.5	---	---	---	---	mA
PLATE CURRENT (2) ( $E_c=-21Vdc$ )	---	50	---	---	---	---	$\mu Adc$
TRANSCONDUCTANCE (1)	2075	3125	2400	2800	---	---	$\mu MHOS$
CHANGE IN INDIVIDUAL TUBES	---	---	---	---	---	15	PERCENT
AVERAGE CHANGE	---	---	---	---	---	15	PERCENT
$\Delta$ TRANSCONDUCTANCE (2) ( $E_f=5.7V$ )	---	15	---	---	---	15	PERCENT
GRID EMISSION <sup>E</sup> ( $E_f=7.5V$ , $E_c=21Vdc$ , $R_g/g=1.0 MEG.$ )	0	-1.5	---	---	---	---	$\mu Adc$
PLATE CURRENT (3) ( $E_c=-14 Vdc$ )	---	---	---	---	---	---	$\mu Adc$
AF NOISE <sup>EA</sup> ( $E_{sig}=70mVac$ , $R_p=0.01MEG.$ )	---	17	---	---	---	---	VU
TRANSCONDUCTANCE (3) ( $E_b=90 Vdc$ , $E_c=0$ )	2400	3600	---	---	---	---	$\mu MHOS$
AMPLIFICATION FACTOR <sup>F</sup>	18	23	---	---	---	---	

SPECIAL REQUIREMENTS

	MIN.	MAX.	
CONTINUITY AND SHORTS <sup>G</sup> (INOPERATIVES)	---	---	
LOW PRESSURE VOLTAGE BREAKDOWN (PRESSURE = $55 \pm 5mm$ HG; VOLTAGE = $500Vdc$ )	---	---	
LOW FREQUENCY VIBRATION <sup>AHK</sup> ( $R_p=2000 OHMS$ )	---	50	mVac
SHOCK <sup>L</sup> (HAMMER ANGLE = $30^\circ$ , $E_{hk}=\pm 100 Vdc$ )	---	---	
VIBRATIONAL FATIGUE <sup>M</sup> ( $G=2.5$ , FIXED FREQUENCY; $F=25$ MIN., $60$ MAX.)	---	---	
POST SHOCK AND VIBRATIONAL FATIGUE TEST END POINTS			
LOW FREQUENCY VIBRATION	---	75	mVac
HEATER CATHODE LEAKAGE ( $E_{hk}=\pm 250 Vdc$ )	---	$\pm 75$	$\mu Adc$
PLATE CURRENT (2)	---	150	$\mu Adc$
$\Delta$ TRANSCONDUCTANCE (1) OF INDIVIDUAL TUBES	---	20	PERCENT
HEATER CYCLING LIFE TEST ( $E_f=7.5V$ , $E_b=E_c=0$ , $E_{hk}=\pm 135 Vdc$ , 1 MIN. ON 4 MIN. OFF)	---	---	

CONTINUED ON FOLLOWING PAGE

## TUNG-SOL

## SPECIAL REQUIREMENTS - CONT'D.

1 HOUR STABILITY LIFE TEST ( $E_{hk}=+250$ Vdc, $R_g/g=1.0$ MEG, $T_A=ROOM$ )	---	---	
STABILITY LIFE TEST END POINTS $\Delta$ TRANSCONDUCTANCE (1) OF INDIVIDUAL TUBES	---	10	PERCENT
100 HOUR SURVIVAL-RATE LIFE TEST (STABILITY LIFE TEST CONDITIONS OR EQUIVALENT, $T_A = ROOM$ )	---	---	
100 HOUR SURVIVAL-RATE TEST END POINTS CONTINUITY AND SHORTS (INOPERATIVES)	---	---	
TRANSCONDUCTANCE (1)	1850	---	$\mu$ MHOS
INTERMITTENT LIFE TEST STABILITY LIFE TEST CONDITIONS $T_A=ROOM$	---	---	

## NOTES

A TIE 1K TO 2K, 1g TO 2g; AND 1p TO 2p.

B SEE MIL-E-1C 4.8.2

C SEE MIL-E-1C

D PRIOR TO THIS TEST, TUBES SHALL BE PREHEATED 5 MINUTES WITH BOTH SECTIONS OPERATING SEPARATELY AT CONDITIONS INDICATED BELOW. THE TUBES SHALL BE TESTED IMMEDIATELY AFTER PREHEATING THE THREE MINUTE TEST IS NOT PERMITTED. GRID EMISSION SHALL BE THE LAST TEST PERFORMED ON THE SAMPLE SELECTED FOR THE GRID EMISSION TEST.  $E_f=7.5$ Vdc,  $E_c1=-8$ Vdc,  $E_b=250$ Vdc,  $R_g=1.0$  MEG.

E SEE MIL-E-1C 4.10.3.2

F SEE MIL-E-1C 4.10.11.1

G SEE MIL-E-1C 4.7.5

H SEE MIL-E-1C 4.19.9.1

K THE IMPEDANCES OF THE PLATE VOLTAGE SUPPLIES SHALL NOT EXCEED THAT OF A  $40\mu$ F CAPACITOR @ 10CPS.

L SEE MIL-E-1C 4.9.20.5

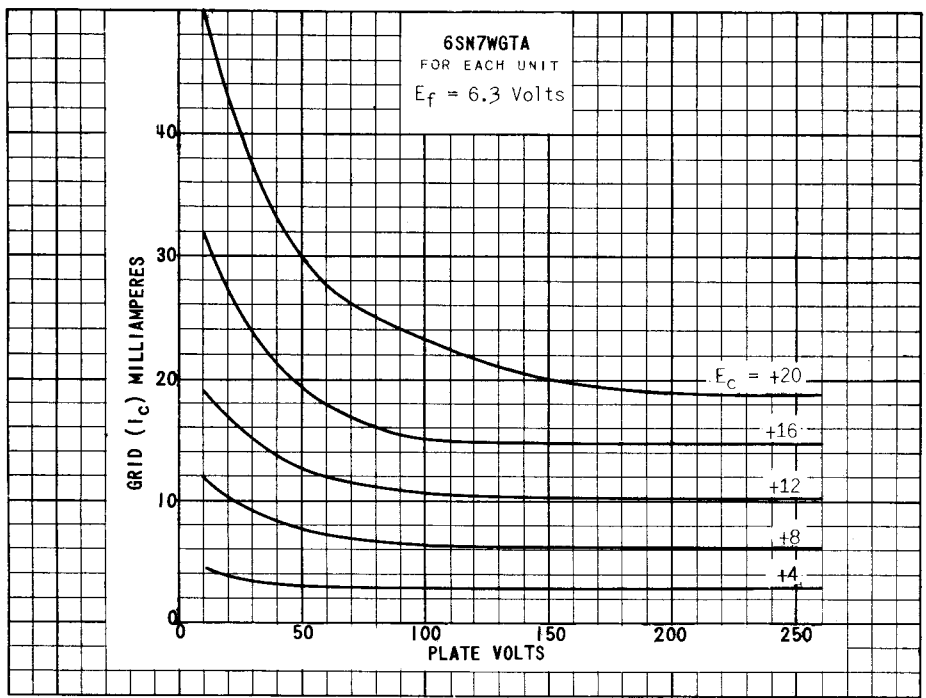
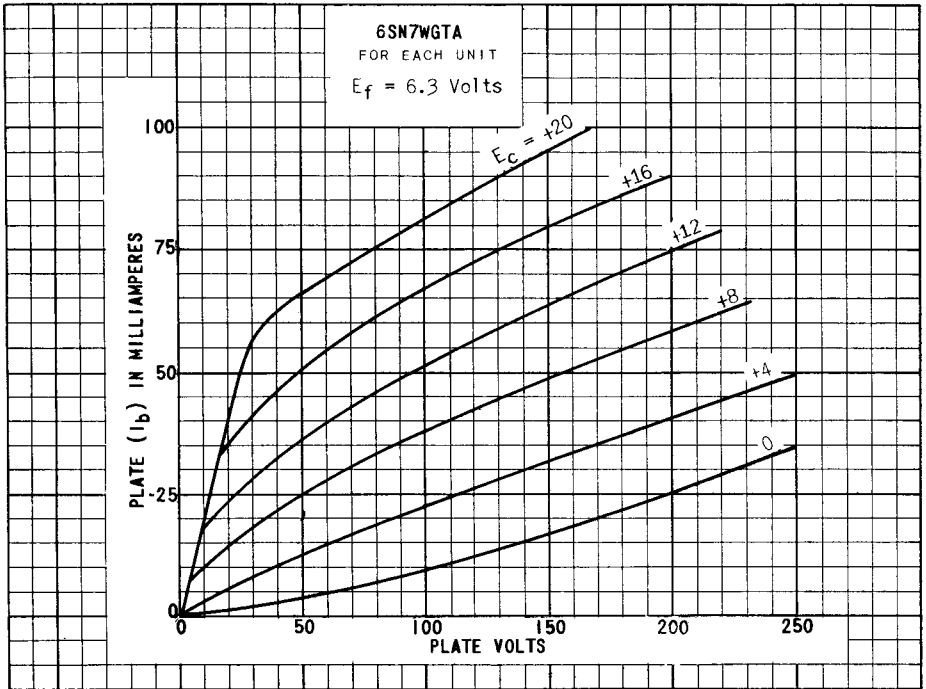

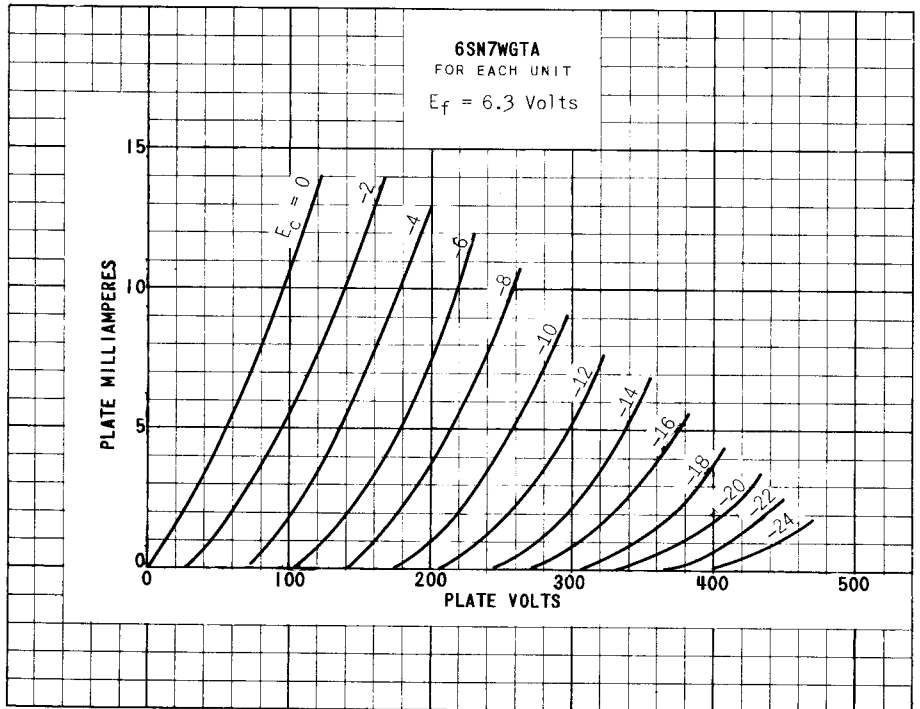
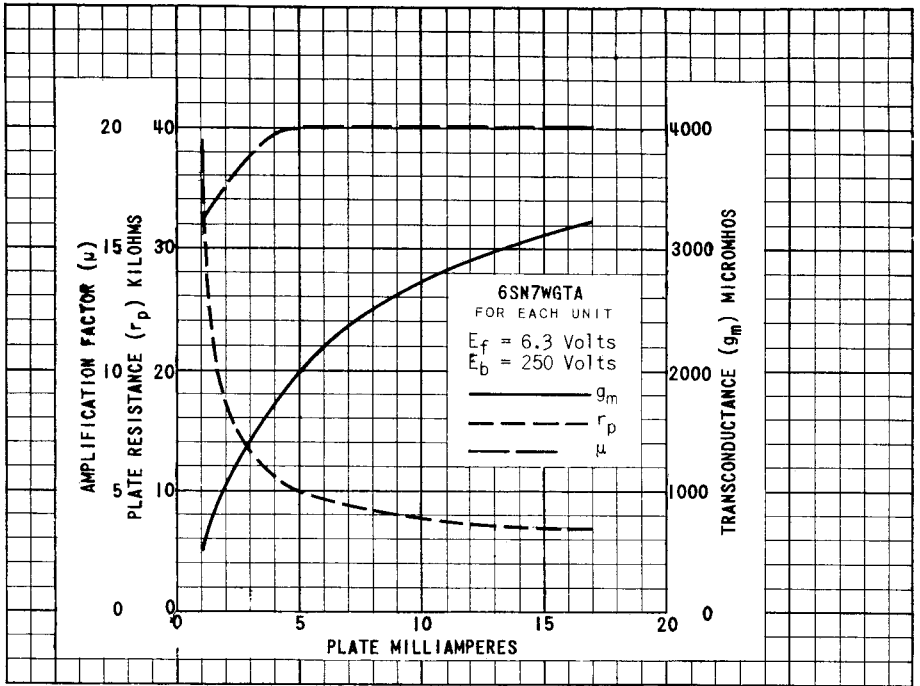

PRINTED IN U. S. A.