

MECHANICAL DATA

Bulb	T-3
Base	E8-10, Subminiature Button Flexible Leads
Outline	JEDEC 3-11
Basing	8DL
Cathode	Coated Unipotential
Mounting Position	Any

RATINGS¹ (Absolute Maximum)

Bulb Temperature	250 °C
Altitude ²	80,000 Ft.
Radiation	
Total Dosage (<i>S</i> neutrons/sq. cm/sec.)	10 ¹⁶ nvt
Dose Rate (neutrons/sq. cm/sec.)	10 ¹² nv

DURABILITY CHARACTERISTICS

Impact Acceleration (³ / ₄ msec Duration)	450 G	Max.
Fatigue (Vibrational Acceleration for Extended Periods)	10 G	Max.

FAILURE RATE RATING

Class (1) — Inoperatives	1.3%/200 Hours
Class (2) — All end points	5.4%/200 Hours
Class (3) — All end points	2.7%/200 Hours

ELECTRICAL DATA

HEATER CHARACTERISTICS

Heater Voltage ³	6.3 V
Heater Current	175 mA

DIRECT INTERELECTRODE CAPACITANCES (Unshielded)

Grid No. 1 to Plate	0.032 μmf	Max.
Input	2.4 μmf	
Output	3.3 μmf	

RATINGS¹ (Absolute Maximum)

Heater Voltage ³	6.3 (-12, +10%) V
Plate Voltage	250 Vdc
Peak Plate Forward Voltage ⁴	360 v
Grid No. 2 Voltage	150 Vdc
Plate Dissipation	0.5 W
Grid No. 2 Dissipation	0.15 W
Average Cathode Current	5.5 mAdc
Grid No. 1 Voltage	
Positive Value	0 Vdc
Negative Value	55 Vdc
Heater-Cathode Voltage	
Heater Positive with Respect to Cathode	200 v
Heater Negative with Respect to Cathode	200 v
Grid No. 1 Circuit Resistance	4.0 Meg

CHARACTERISTICS

Plate Voltage	100 Vdc
Grid No. 2 Voltage	100 Vdc
Cathode Resistor	1500 Ohms
Plate Current	0.7 mAdc
Grid No. 2 Current	0.10 mAdc
Transconductance	1100 μmhos
Plate Resistance	1.2 Meg
Grid No. 1 Voltage for <i>I</i> _b = 50 μAdc Max.	-3.0 Vdc

QUICK REFERENCE DATA

The Premium Subminiature Type 6788 is a sharp-cutoff pentode designed for guided missile service. It is intended for use as a high gain audio amplifier or regulator amplifier where high plate loads are desired at low plate currents. The 6788 is characterized by extraordinary freedom from interelement shorts of short duration, by high resistance to interelement leakage.

The 6788 is designed to provide dependable service under conditions of severe mechanical shock, vibration, high temperature and high altitude, and is manufactured and inspected to meet the applicable specification for reliable operation.

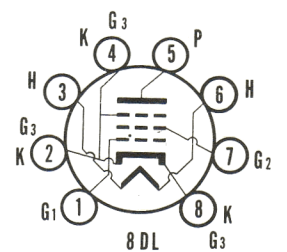
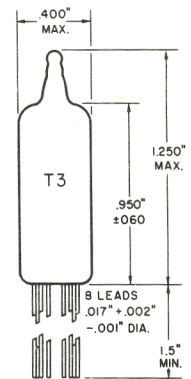

sylvania electronic tubes

A Division of
Sylvania Electric Products Inc.

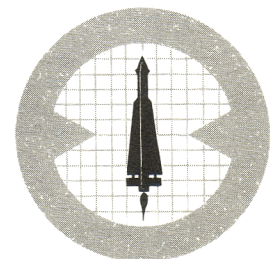

NOTES:

1. Limitations beyond which normal tube performance and tube life may be impaired.
2. If altitude rating is exceeded, reduction of instantaneous voltages (E_f excluded) may be required.
3. Tube life and reliability of performance are directly related to the degree of regulation of the heater voltage to its center-rated value of 6.3 volts. The Min. and Max. values are 5.5 and 6.9 volts respectively.
4. MIL-E-1D, Par. 6.5.1.1 does not apply. Peak voltage shown should not be exceeded.

ACCEPTANCE CRITERIA

Test Conditions

Heater Voltage	6.3 V	Grid No. 2 Voltage	100 Vdc
Plate Voltage	100 Vdc	Heater-Cathode Voltage MIL-E-1 Par. 3.2.26.1	0 V
Grid No. 1 Voltage	0 V	Cathode Resistor	1500 Ohms

For the purposes of inspection, use applicable reliable paragraphs of MIL-E-1.

MIL-E-1 Ref.	Test	AQL (%)	Limits — Note 2					Units
			Min.	LAL	Bogey	UAL	Max.	
Measurements Acceptance Tests, Part 1, Note 1								
4.10.8	Heater Current	0.65	165	—	175	—	185	mA
4.10.15	Heater-Cathode Leakage	0.65	—	—	—	—	—	—
	E _{hk} = +100 Vdc	—	—	—	—	—	5.0	μAdc
	E _{hk} = -100 Vdc	—	—	—	—	—	5.0	μAdc
4.10.6.1	Grid Current: I _{c1}							
	E _b = E _{c2} = 125 Vdc; E _{c1} = -1.8 Vdc;							
	R _k = 0; R _{g1} = 1.0 Meg	0.65	0	—	—	—	-0.1	μAdc
4.10.4.1	Plate Current (1): I _b ALD = 0.17	—	—	0.62	0.7	0.78	—	mAdc
4.10.4.1	Plate Current (1):	0.65	0.5	—	—	—	0.9	mAdc
4.10.4.1	Plate Current (2):							
	E ₁ = -3.0 Vdc; R _k = 0 Ohms	0.65	—	—	10	—	50	μAdc
4.10.4.3	Screen Grid Current: I _{c2}	0.65	—	—	0.10	—	0.20	mAdc
4.10.9	Transconductance (1): ALD = 175 Sm	0.65	—	1025	1100	1175	—	μmhos
4.10.9	Transconductance (1): S _m	—	900	—	—	—	1300	μmhos
4.7.5	Continuity and Shorts (Inoperatives):	0.4	—	—	—	—	—	—
4.9.1.1	Mechanical:							
	Envelope JEDEC 3-11	—	—	—	—	—	—	—
Measurements Acceptance Tests, Part 2								
4.8.2	Insulation of Electrodes	2.5	—	—	—	—	—	—
	E _{g1} -all = -100 V	—	500	—	—	—	—	Meg
	E _p -all = -300 V	—	500	—	—	—	—	Meg
	E _{g2} -all = -200 V	—	500	—	—	—	—	Meg
4.10.9.1	Transconductance (2): Δ S _m							
	E _f = 5.5 V	2.5	—	—	—	—	15	%
4.10.4.1	Plate Current (3): E _{c1} = -2.5; R _k = 0	2.5	5.0	—	50	—	—	μAdc
4.10.6.2	Grid Emission: Notes 3 and 4; I _{c1}							
	E _f = 7.5 V; R _{g1} = 4.0 Meg; R _k = 0 Ohms							
	E _{c1} = -3.0 Vdc	2.5	0	—	—	—	-0.5	μAdc
4.10.3.2	AF Noise: Note 5							
	E _{sig.} (Cal.) = 70 mVac; E _{c2} = 19 Vdc;							
	R _{g1} = 0.1 Meg; R _{g2} = 1000 Ohms;							
	R _p = 0.2 Meg; C _k = 1000 μf	2.5	—	—	—	—	—	—
----	Hum: Note 6							
	E _f = 6.3 Vac @ 400 cps; E _b = E _{c1} =							
	E _{c2} = 0; R _k = 10,000 Ohms	2.5	—	—	—	—	15	mv pk-pk
----	Operation Time: Note 7	6.5	—	—	—	—	20	secs
4.10.10	Plate Resistance:	6.5	0.8	—	1.2	—	—	Meg
4.10.14	Capacitance: Shield No. 318	6.5	—	—	—	—	—	—
	C _{g1p}	—	—	—	—	—	0.032	μμf
	C _{in}	—	1.8	—	2.4	—	3.0	μμf
	C _{out}	—	2.5	—	3.3	—	4.1	μμf
4.9.12.1	Low Pressure Voltage Breakdown: Note 8							
	Pressure = 21 ± 2 mm Hg; Voltage = 300 Vac	6.5	—	—	—	—	—	—
4.9.19.1	Vibration (1):							
	R _p = 10,000 Ohms; C _k = 1000 μf;							
	F = 40 cps; G = 10	1.0	—	—	—	—	5	mVac
----	White Noise Vibration: Notes 9 and 10							
	R _p = 10,000 Ohms; C _k = 1000 μf	2.5	—	—	—	20	50	mv pk-pk
	Peak Acceleration = 15 G	2.5	—	—	—	3	5	mVac

SYLVANIA GUIDED MISSILE TUBES

6788

ACCEPTANCE CRITERIA (Continued)

MIL-E-1 Ref.	Test	AQL (%)	Limits — Note 2					Units
			Min.	LAL	Bogey	UAL	Max.	
Degradation Rate Acceptance Tests, Note 4								
4.9.5.3	Subminiature Lead Fatigue	2.5	4	—	—	—	—	arcs
4.9.20.5	Shock: Note 11 Hammer Angle = 30°;	20	—	—	—	—	—	
4.9.20.6	Fatigue: Notes 8 and 12 G = 10; Variable Frequency	6.5	6	—	—	—	—	Hours
----	Post Shock and Fatigue Test End Points:							
	Vibration (1):	—	—	—	—	—	15	mVac
	Heater-Cathode Leakage							
	Ehk = +100 Vdc	—	—	—	—	—	15.0	μAdc
	Ehk = -100 Vdc	—	—	—	—	—	15.0	μAdc
	Change in Transconductance (1) of Individual Tubes Δ Sm	—	—	—	—	—	15	%
4.9.6.3	Glass Strain	4.0	—	—	—	—	—	
Acceptance Life Tests, Note 4								
4.11.7	Heater Cycling Life Test (1): (2000 Cycles Min.) Note 13 Ef = 7.0 V; 1 min. on, 4 min. off; Ehk = 140 Vac; Ec1 = Ec2 = Eb = 0 V	2.5	—	—	—	—	—	
4.11.7	Heater Cycling Life Test (2): (300 Cycles Min.) Note 13 Ef = 10 V; Ehk = +200 Vdc; 10 secs. on, 4 min. off; Eb = Ec1 = Ec2 = 0	10.0	—	—	—	—	—	
4.11.3.1	Stability Life Test: Note 14 Eb = 250 Vdc; Ec2 = 150 Vdc; Rk = 680 Ohms; Ehk = +200 Vdc; Rg1 = 4.0 Meg; TA = Room	—	—	—	—	—	—	
4.11.4	Stability Life Test End Points: Change in Transconductance (1) of Individual Tubes Δ Sm	1.0	—	—	—	—	15	%
4.11.3.1	Survival Rate Life Test: (100 Hours) Note 15 Ebb = 250 Vdc; Tie Grid No. 2 to Plate; Rk = 110 ohms; Rp = .03 Meg; Rg1 = 4.0 Meg; TA = Room	—	—	—	—	—	—	
4.11.4	Survival Rate Life Test End Points: Continuity and Shorts (Inoperatives)	0.65	—	—	—	—	—	μmos
	Transconductance (1) Sm	1.0	800	—	—	—	—	μAdc
	Grid Current	2.5	0	—	—	—	-0.1	μAdc
	Heater-Cathode Current: Ihk	0.65	—	—	—	—	10	μAdc
	Electrode Insulation:	6.5	—	—	—	—	—	
	Rg1-all	—	200	—	—	—	—	Meg
	Rg2-all	—	200	—	—	—	—	Meg
	Rp-all	—	200	—	—	—	—	Meg

MIL-E-1 Ref.	Test	LOT ACCEPTANCE LIMITS (1)		FAILURE RATE CLASS (3) LIMITS		Units
		MIN.	MAX.	MIN.	MAX.	
4.11.5	Intermittent Life Test: Notes 16 and 17; Survival Rate life conditions; T Envelope = 250°C Min.	—	—	—	—	
4.11.4	Intermittent Life Test End Points: (200 Hours)					
	Inoperatives: Note 18	—	—	—	—	
	Grid Current	0	-0.5	0	-1.0	μAdc
	Heater Current	165	190	160	195	mA
	Change in Transconductance (1) of Individual Tubes; Δ Sm/t	—	20	0	25	%
	Transconductance (2): Δ Sm/Ef	—	15	—	25	%
	Heater-Cathode Leakage					
	Ehk = ±100 Vdc	—	10	—	15	μAdc
	Insulation of Electrodes					
	g1-all	200	—	25	—	Meg
	p-all	200	—	25	—	Meg
	g2-all	200	—	25	—	Meg
	Transconductance (1) Average change Avg. Δ Sm/t	—	15	—	—	%

ACCEPTANCE CRITERIA (Continued)

MIL-E-1 Ref.	Test	ALLOWABLE DEFECTIVES
Acceptance	Life Tests, Note 4 (Cont'd.)	
----	Individual Lot Acceptance:	
	Total Inoperatives	2
	Total Defectives	5
----	Failure Rate Tests: Note 17	
	Failure Rate Class 1	
	Inoperatives:	5
	Failure Rate Class 2	
	Combined defectives to Limits (1)	
	Including Inoperatives:	16
	Failure Rate Class 3	
	Combined defectives to Limits (3)	
	Including Inoperatives:	8

ACCEPTANCE CRITERIA NOTES:

- The AQL for the combined defectives for attributes in Measurements Acceptance Tests, Part 1, excluding Inoperatives and Mechanical shall be one (1) percent. A tube having one (1) or more defects shall be counted as one (1) defective.
- For Variables Sampling Procedure, see MIL-E-1, Appendix C, Paragraph 20.2.4.
- Prior to this test, tubes shall be preheated for 5 minutes at the conditions indicated below. Test within three seconds after preheating. Three minute test is not permitted. Grid Emission is a destructive test so tubes subjected to it are not to be accepted under this specification, nor are subsequent tests to be performed on the same tubes.

Ef	Eb	Ec1	Ec2	Ec3	Rk/k	Rg1
V	Vdc	Vdc	Vdc	Vdc	ohms	Meg
7.5	250	0	150	—	680	4.0

- Destructive Tests: Tubes subjected to the following destructive tests are not to be accepted under this specification.
 - 4.9.5.3 Subminiature Lead Fatigue
 - 4.9.20.5 Shock
 - 4.9.20.6 Fatigue
 - 4.11.7 Heater Cycling Life Tests (1) & (2)
 - 4.11.5 Intermittent Life Test
 - 4.10.6.2 Grid Emission
- The rejection level shall be set at the VU meter reading obtained during calibration.
- Maximum total distortion of the filament supply voltage shall be 5%. The frequency response of the peak-to-peak measuring device from 20 cps to 5000 cps must be within 0.5 db of its response at 400 cps. Ground all leads except those for the cathodes and heater lead #3. Measure Hum voltage across specified Rk in each cathode separately.
- Insert a cold tube into the test socket having all Plate Current (1) conditions applied and record Ib continuously for three minutes. Plate Current must reach 85% of the three minute figure within the time indicated.
- This test shall be conducted on the initial lot and thereafter on a lot approximately every 30 days. In the event of lot failure, the lot shall be rejected and the succeeding lot shall be subjected to this test. Once a lot has passed, the 30-day rule shall apply. MIL-STD-105, Sample Size Code Letter F shall apply.
- The tube shall be rigidly mounted on a table vibrating such that the instantaneous values of acceleration shall constitute approximately a "WHITE NOISE" spectrum which is free from discontinuities from 100 cps to 5000 cps and such that the RMS value of acceleration for frequencies outside this band shall constitute no more than five percent of the total RMS acceleration. The spectrum of instantaneous acceleration shall be such that each octave of bandwidth delivers 2.3 ± 0.2 G's RMS acceleration. With this the case, the RMS value of acceleration for any bandwidth within the specified spectrum is equal to:

$$\text{Grms} = 2.3 \sqrt{3.32 \log_{10} (f_2/f_1)}$$

where f2 and f1 are the upper and lower frequencies respectively of the band under consideration. The degree of clipping

of the peak accelerations shall be such that the peak value of acceleration is at least 15 G's.

Half the tubes in the sample shall be vibrated in position X1, the other half in position X2.

The voltage (ep) produced across the resistor (Rp) as a result of vibration shall be coupled through a compensating amplifier to a low pass filter. The compensating amplifier shall have a high input impedance (250 Kohms or more) and shall be adjusted to compensate for any insertion losses in the filter. The combined frequency response of amplifier and filter shall be flat within ± 0.5 db from 50 cps to 8000 cps, shall be down no more than 5 db at 10,000 cps and at 20 cps, and down at least 30 db to 13,000 cps. For reading the peak-to-peak value of output voltage, the filter output shall be fed directly to the input of a Ballantine Model 305 peak-to-peak electronic voltmeter or equal, while the RMS value shall be measured with a Hewlett Packard Model 400 C or equal. The impedance of the plate and screen voltage supplies shall not exceed that of a 40 μ f capacitor at 10 cps.

- For variables sampling procedure, use MIL-E-1, Appendix C, par. 20.2.4.2.2.
- A grid resistor of 0.1 meg shall be added; however, this resistor will not be used when a thyratron type short indicator is employed.
- The tubes shall be rigidly mounted on a table vibrating at a constant acceleration level of 10 G. The frequency of vibration shall be varied from 30 cps to 3000 cps and back to 30 cps, with the period of the sweep cycle being three minutes. The rate of change of frequency with time shall be such that the frequency varies logarithmically with time. The tubes shall be vibrated for a total of six hours, that is, two hours in each of the three positions X1, X2 and Y1. Filament voltage only shall be applied to the tube under test.
- The no load to steady state full load regulation of the heater voltage supply shall be not more than 3.0%.
- The sampling and testing procedure for the Stability Life Test shall be in accordance with MIL-E-1, Appendix C, Section 20.2.5.1.
- For Survival Rate Life Test, the sampling and testing procedure shall be as defined in Sections 20.2.5.2 to 20.2.5.2.5 inclusive of MIL-E-1, Appendix C.
- Envelope temperature is defined as the highest temperature indicated when using a thermocouple of No. 40B and S, or small diameter elements welded to a ring of 0.025 inch diameter phosphor bronze placed in contact with the envelope. The envelope temperature requirement will be satisfied if a tube, having bogey Ib (± 5 percent) under normal conditions, is determined to operate at or above the minimum specified temperature in any socket of the life-test rack.
- 1.0 Intermittent Life Test Evaluation:** The life test conducted in accordance with this specification shall be evaluated in two separate procedures. The first will be an evaluation on an individual lot basis in a similar manner to the one normally specified for reliable tubes. The second evaluation is the determination of a failure rate and its compliance to this specification.

ACCEPTANCE CRITERIA NOTES (Continued)

The life test will be conducted in accordance with MIL-E-1 procedures for reliable tubes except that the sampling plan will be changed from the presently specified double sampling plan to a single sampling plan with $n = 40$. Individual lot acceptance will be based on this sample size and the conformance of the lot to the maximum allowable defectives for inoperatives and also for combined defectives as specified.

2.0 The Failure Rate Control:

- a. Purpose: It is the purpose of this specification to establish a means by which the Military may monitor and evaluate the failure rate of this tube type in order to provide a statistically valid description of this parameter that may be utilized in computing the reliability of equipments in which this type is used.
- b. Description: The failure rates on this type shall be evaluated using the life test information gathered on individual lots. Only those lots that pass the life test criteria for individual lots shall be used in the calculations for failure rates. The failure rate shall be based on a 5 lot moving average with the cumulative number of failures for each failure rate class plotted on their respective failure rate charts (See Charts 1, 2, and 3). Non-conformance of a tube to the 200 hour end points shall be considered a failure.

The failure rate charts consist of a plot of consecutive lots manufactured with each point indicating the cumulative number of failures in the last five lots as evaluated against the specified criteria. In the operation of this procedure, each time a new lot is added, the number of defects from the earliest lot is dropped from the accumulation of defectives so that each plotted point on the chart will represent a total sample size of 200 tubes.

Any lot which fails the individual lot acceptance criteria shall not be included in the cumulations for failure rate and the defectives shall not be added into the cumulative number of defectives as plotted on the failure rate charts. However, the number of defectives for such a failing lot should be plotted on the failure rate chart in its chronological order with the other lots. This point is plotted for information only.

- c. Qualification: In order to become a qualified source to this specification, it is mandatory that the manufacturer supply data on charts 1, 2, and 3 indicating that his failure rate is within the acceptable limits. A total quantity of 200 tubes life tested for 200 hours is required and this should be representative of two or more

consecutively manufactured lots (e.g., 100 tubes from each of 2 lots or 40 from each of 5 lots). In the event more than 40 tubes per lot are used in the life test sample in order to accelerate qualification for failure rate, only the first 40 tubes life tested per lot shall be evaluated for the individual lot acceptance criteria.

- d. Maintenance of Failure Rate: When the manufacturer has become a qualified source to this specification and has received proper approval from the Military, those lots utilized for qualification and subsequent lots where the 5 lot moving evaluation failure rate continues within the specification, are to be considered acceptable to this specification and may be marked and shipped accordingly.
- e. Non-conformance of Failure Rate: The failure rate will be considered non-conforming when the total number of defectives (for the particular failure rate under evaluation) accumulated from the past 5 lot life test exceeds the number permissible as contained in the specification and on the failure rate chart. The lot of tubes which caused the failure rate limit to be violated shall be considered as acceptable and can be marked and shipped in accordance with this specification. When a failure rate criteria has been violated, the manufacturer has lost qualification to this specification and cannot mark and ship any subsequent lots to this specification without being requalified.
- f. Requalification for Failure Rate: Since all three failure rates specified in this specification are computed from the same life test data, a violation of 1 failure rate requires requalification for all three failure rates. Requalification shall follow the same procedure as for original qualification. Starting after the last lot which rendered disqualification, a life test sample of 200 tubes from the next two new consecutive lots will be required to conform to this specification before qualification is reinstated to the manufacturer.
- g. Charts: Each manufacturer intending or planning to supply tubes to this specification must forward his qualification data in the form of the three failure rate charts to the Military. These charts must be duly approved and signed by the Resident Government Inspector as representing the factual results of the life tests which were conducted in complete accordance with MIL-E-1 and this specification.

- 18: An inoperative as referenced in Life Tests shall be defined as a tube having one (1) or more of the following defects: Discontinuity (Ref. 4.7.1), Permanent Shorts (Ref. 4.7.2), Air Leaks (Ref. 4.7.6).

APPLICATION DATA

The Type 6788 is a Premium Subminiature sharp cut-off pentode designed for audio amplifier service. It has particular advantage as a high gain audio amplifier or regulator amplifier where high plate loads are desired at low plate current.

This type is characterized by extraordinary freedom from interelement short circuits of short term duration, by high resistance to interelement leakage, and by stable performance. In addition, vibrational output when the tube is subjected to wide band (White Noise) vibration is held to a very low value. It is designed for service at high altitudes and where severe conditions of mechanical shock, vibration and high temperature are encountered. These characteristics give the type special value in guided missile applications.

Tube durability under extreme vibration for extended periods is assured by more stringent fatigue testing techniques. Excitation for the fatigue test varies in frequency from 30 cps to 3,000 cps and back to 30 cps. Three minutes are required to sweep through one complete cycle. The sweep frequency vibration has a constant acceleration level of 10 G in contrast to the 2.5 G level used on most reliable receiving tube types. The sweep frequency cycle is repeated continuously for two hours in each of three positions, totalling six hours.

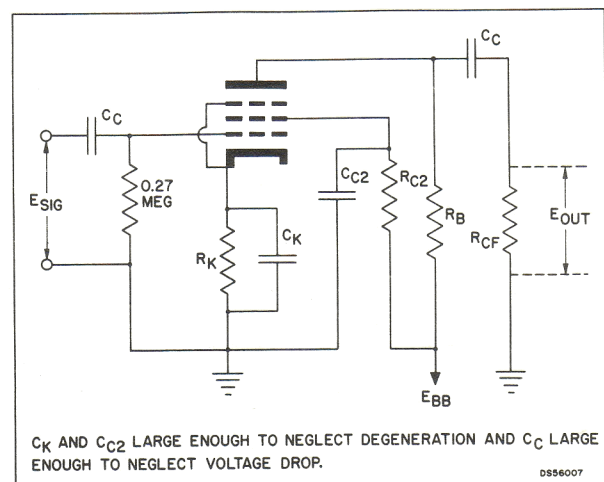

Resistance Coupled Amplifier Data

described by the life tests, specified on the attached pages. The actual life expectancy of the tubes in an operating circuit is affected by both the operating and environmental

APPLICATION DATA (Continued)

To insure correlation with actual field conditions and thereby enhance equipment reliability, vibrational noise output is controlled by the "white noise test" as shown in the acceptance criteria. Briefly, this test consists of subjecting the tube to a white noise vibration spectrum covering the frequency band of 100 to 5000 cps at a rms level of 2.3 g's per octave and a peak level of 15 g's. Limits are shown for both peak and rms output. A further discussion of the white noise vibrational test is included in the frontal section of this manual.

The 6788 is manufactured and inspected to meet the applicable specification for reliability. Life expectancy is

conditions involved. Likewise, the life tests specified indicate performance under certain operating criteria to a set of specified end points. Performance at conditions other than those specified can usually be estimated only roughly as giving better or poorer life expectancy. For further discussion of life expectancy, reference should be made to the frontal section of this manual.

When operated under conditions common to on-off control applications, the tube exhibits freedom from the development of interface resistance. The heater-cathode construction is designed to withstand intermittent operation.

RESISTANCE COUPLED AMPLIFIER DATA

	Ebb = 100 Volts						Ebb = 250 Volts					
	0.1 .82		0.27 2.2		0.47 3.9		0.1 0.82		0.27 2.2		0.47 3.9	
Rb (megohms)												
Rc2 (megohms)												
Rcf (megohms)	0.27	0.47	0.47	1.0	0.47	1.0	0.27	0.47	0.47	1.0	0.47	1.0
Rk (ohms)	1800	1800	4700	3900	6800	6800	560	1000	1500	1200	2200	2200
Ib (ma)400	.400	.177	.187	.118	.116	1.36	1.16	.575	.61	.365	.367
Ic2 (ma)055	.054	.024	.026	.016	.016	.19	.17	.082	.083	.050	.050
Ec1 (volts)	-.82	-.82	-.95	-.83	-.91	-.89	-.87	-1.36	-1.02	-.83	-.92	-.92
Ec2 (volts)	54.1	55.0	46.2	46.4	38.7	38.7	96.	113	72.	66.	56	56
Eb (volts)	59.2	59.2	51.2	49.1	44.6	44.6	113.	129	87.	85.	76	76
Esig (volts, rms)	0.05	0.05	0.05	0.05	0.05	0.05	0.10	0.10	0.10	0.10	0.10	0.10
Eout (volts, rms)	3.3	3.65	4.5	5.9	4.7	6.2	9.3	10.1	16.2	19.8	18.2	23.6
Gain	66.	73.	90.	118.	94.	124.	93.	101	162.	198.	182.	236.
% Distortion	2.0	2.0	3.9	3.75	4.6	4.25	0.9	1.0	1.8	1.17	3.7	3.2
Esig* (volts, rms)	0.09	0.10	0.07	0.07	0.06	0.06	0.18	0.47	0.25	0.13	0.14	0.17
Eout (volts, rms)	5.9	7.28	6.3	8.2	5.6	7.35	16.6	45.	39.	25.7	25.3	38.
Gain	65.5	72.8	90.	117.	93.	122.	92.	96.	156.	198.	181.	224.
% Distortion	3.4	3.8	5.0	5.0	5.0	5.0	1.4	5.0	4.8	1.70	5.0	5.0

*Maximum signal for 5% distortion or 1/8 microampere grid current.

AVERAGE PLATE CHARACTERISTICS

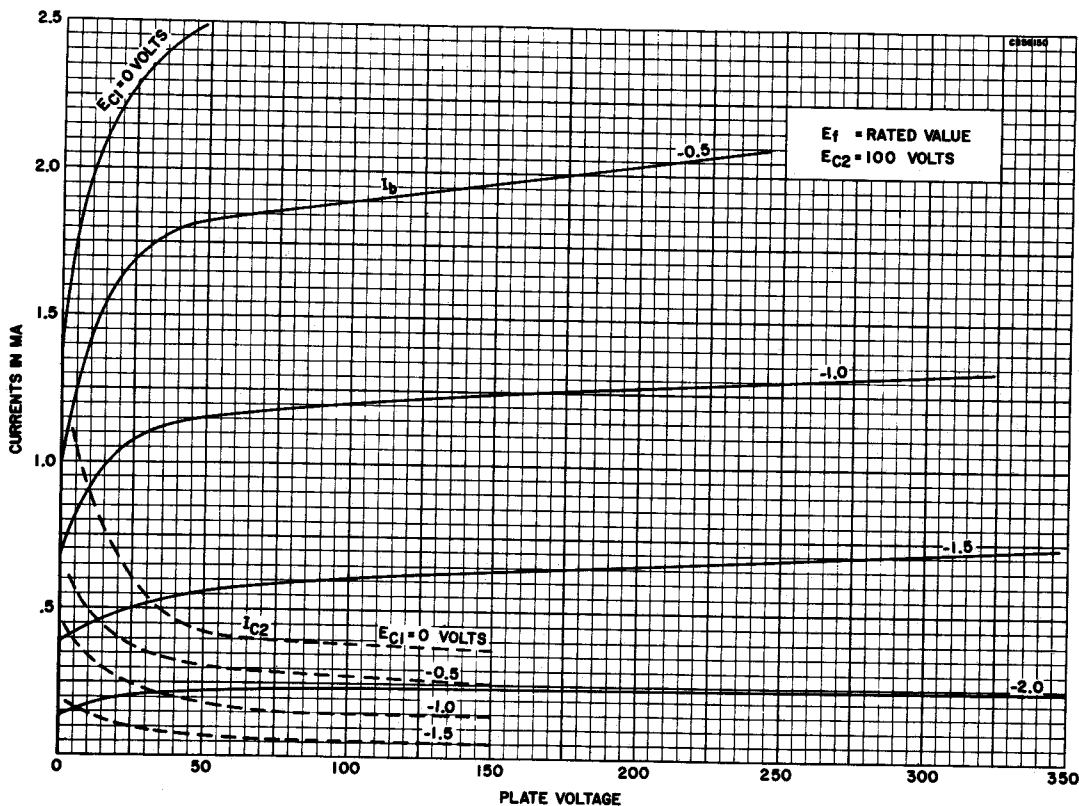

AVERAGE PLATE CHARACTERISTICS

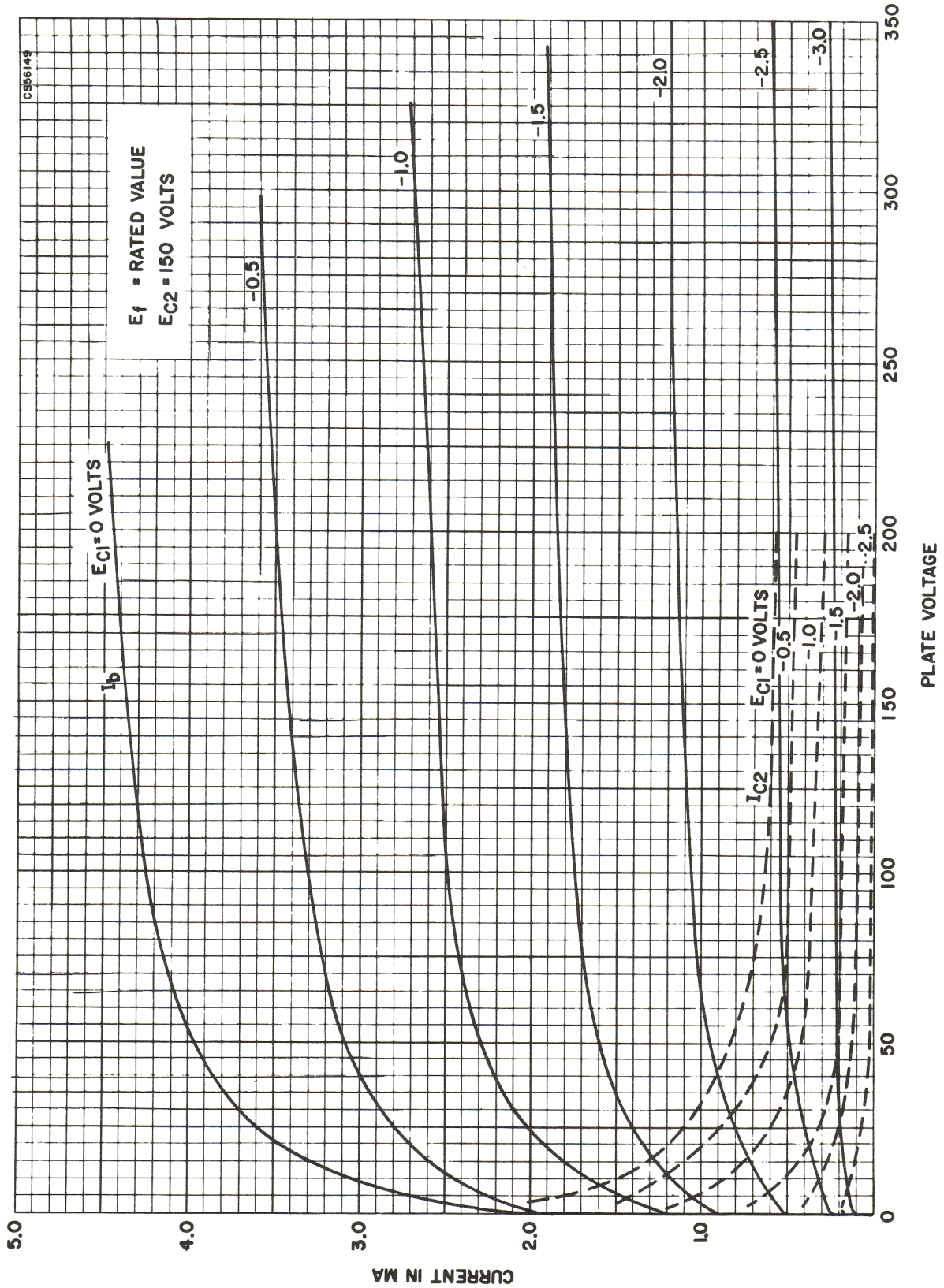

AVERAGE TRANSFER CHARACTERISTICS (Pentode Connected)

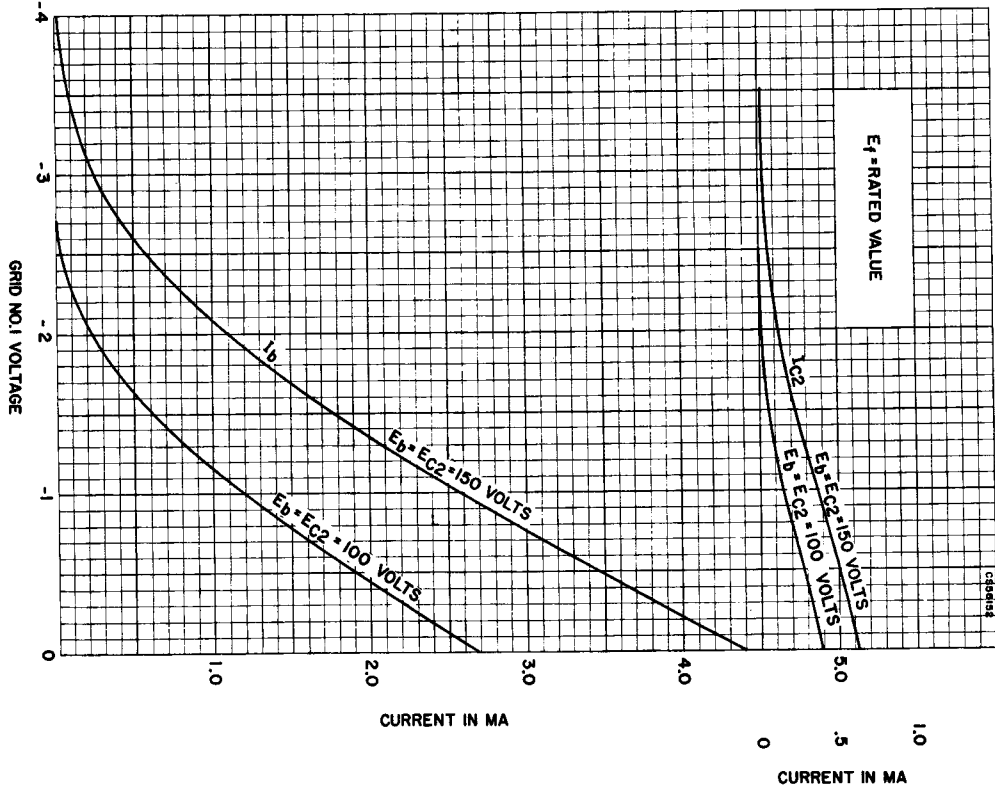

AVERAGE TRANSFER CHARACTERISTICS (Pentode Connected)

