

onderdeel 673  
 in 482 kast

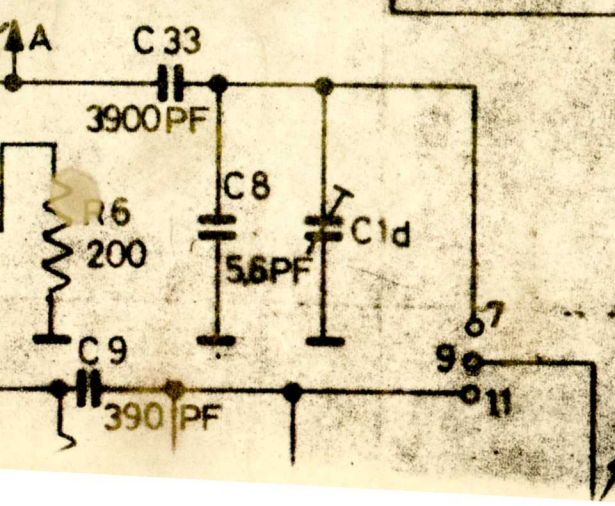

ED 1502 C,D,E

ED 1502 D

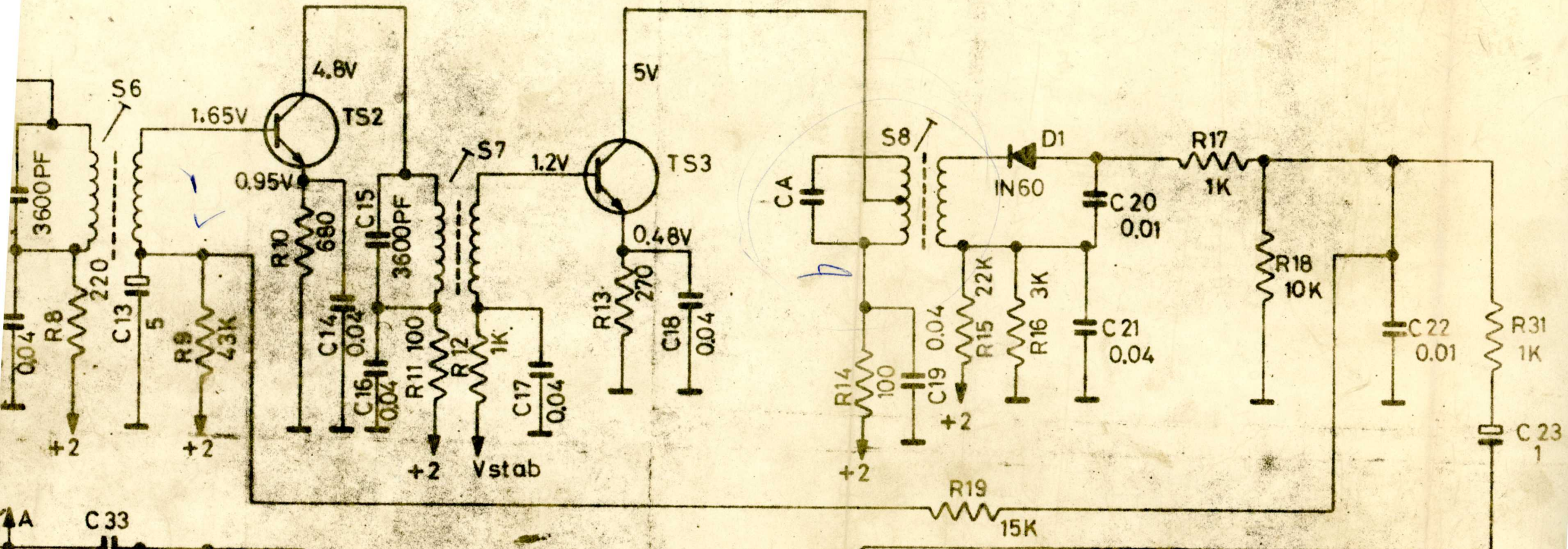

*R Potem 20k*

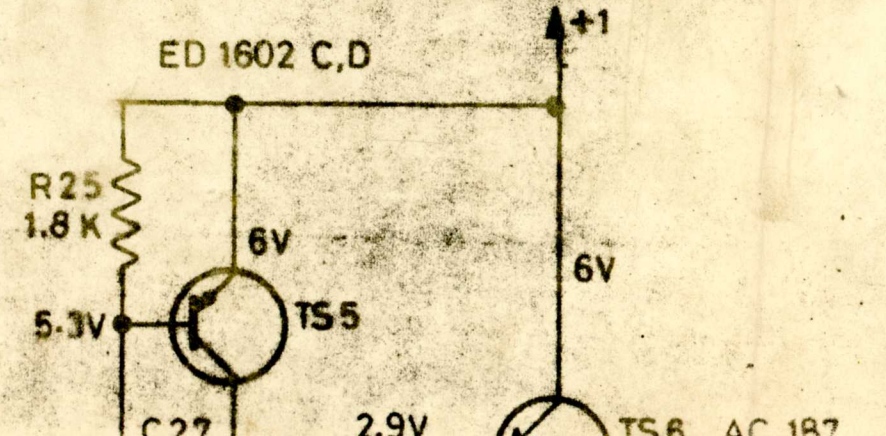



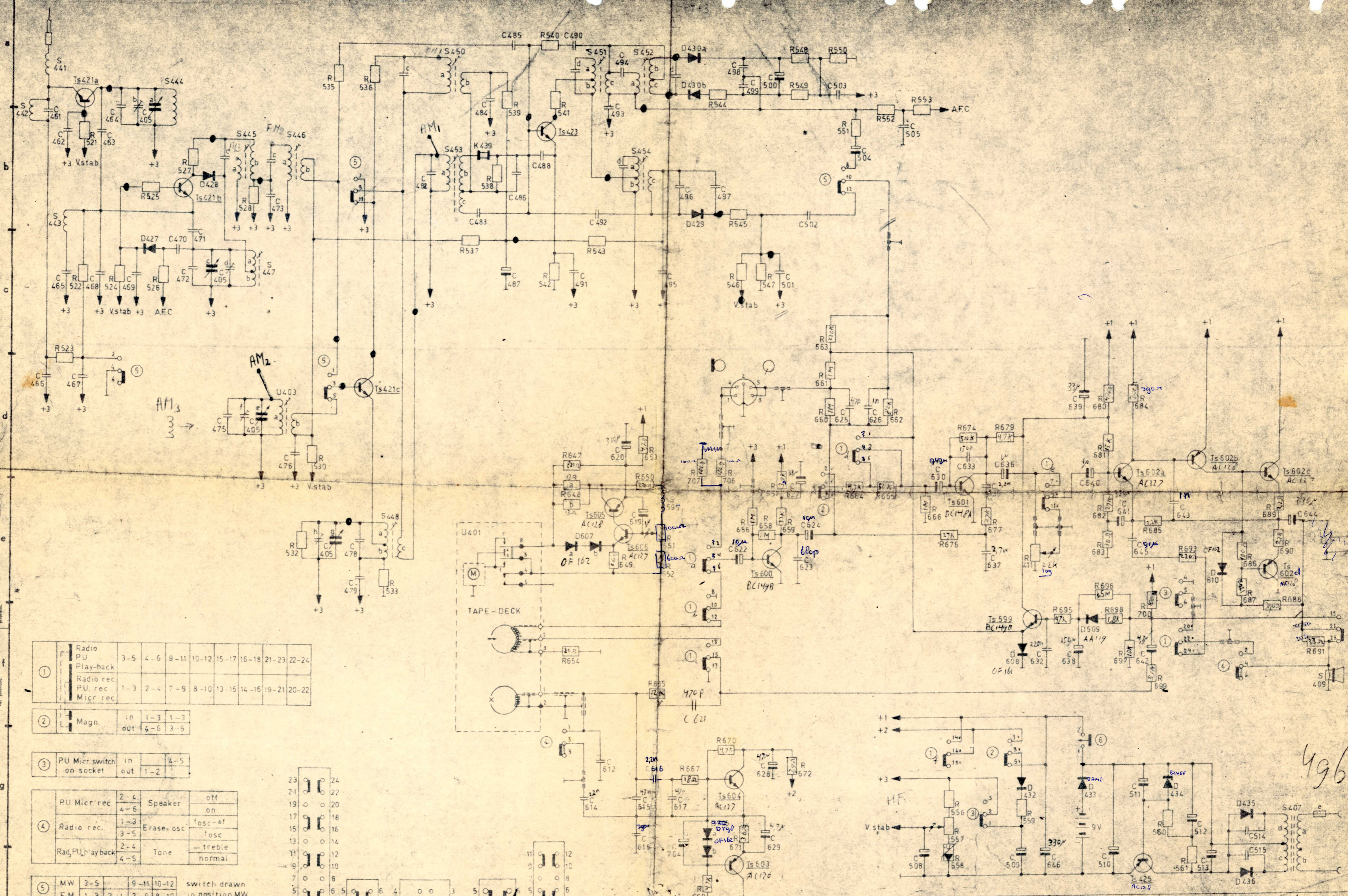

①	Radio PU	3-5	4-6	9-11	10-12	15-17	16-18	21-23	22-24
	Play-back								
	Radio rec	1-3	2-4	7-9	8-10	13-15	14-16	19-21	20-22
	PU rec								
	Micr rec								

②	Magn.	in	1-3	1-3
		out	4-6	3-5

③	PU Micr switch	in		4-5
	on socket	out	1-2	

④	PU Micr. rec	2-4	Speaker	off
		4-6		on
	Radio rec.	1-3	Erase-osc	fosc-Af
		3-5		fosc
	Rad. PU play-back	2-4	Tone	-treble
		4-5		normal

⑤	MW	3-5	9-11	10-12	switch drawn in position MW
	FM	1-3	2-4	7-9	

⑥	on/off switch	on R41
---	---------------	--------

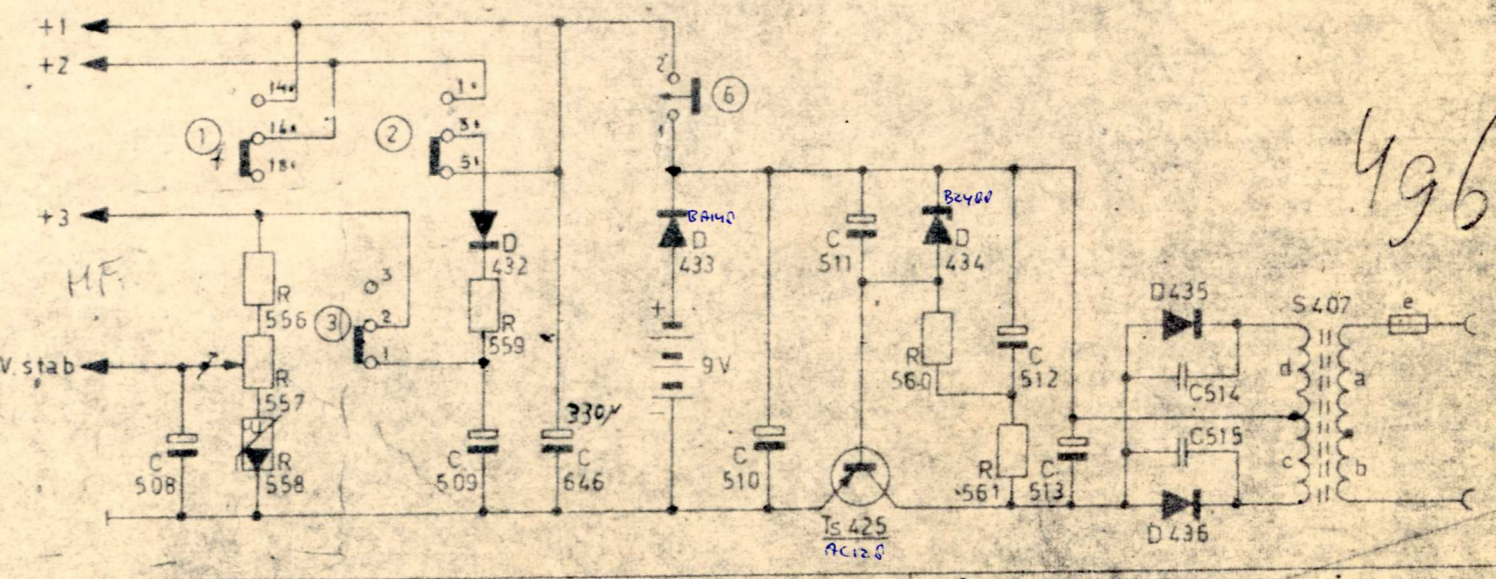
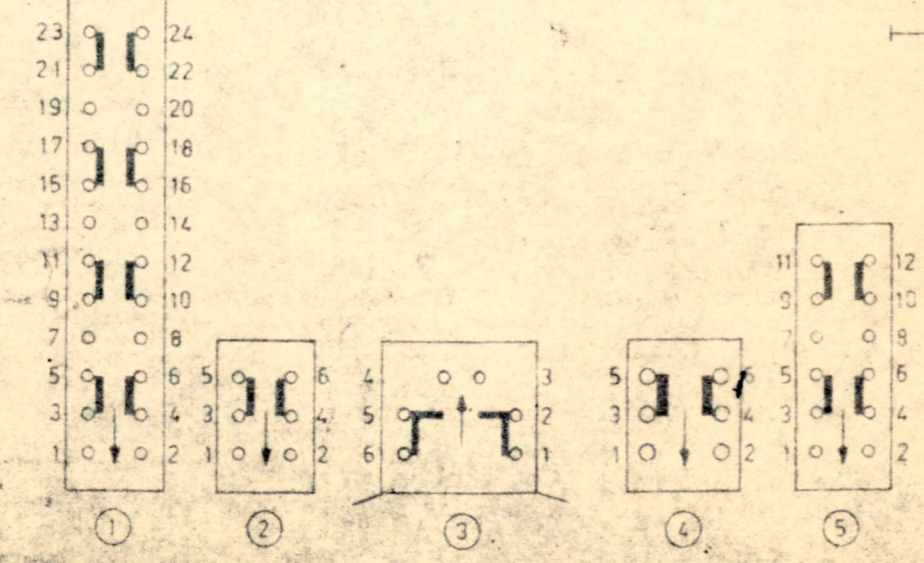

RECORDER-RECEIVER-COMB. 22RR392/00  
 RECORDER-ONTVANGER-COMB. 9022 083 92009

NAME SANDERS/DUYN  
 N.V. PHILIPS' GLOEILAMPENFABRIEKEN, EINDHOVEN, NEDERLAND

1st circuit diagram  
 9022 083 92009

DATE 20-2-69



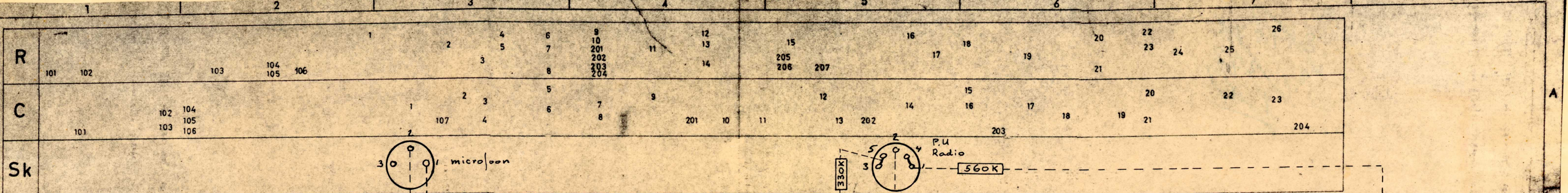

**Sk1 (Kontakt 1-16)**  
verbundener Kontakt bei:

AUFNAHME	WIEDERGABE
1-2	2-8
8-11	+
5-7	
13-15	
12-14	
14-16	

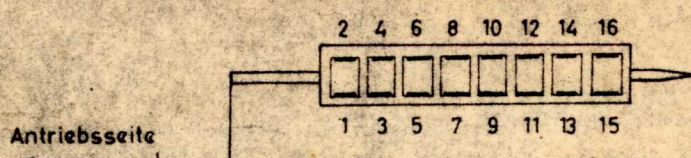

Kontaktfedern von Printseite aus gesehen!

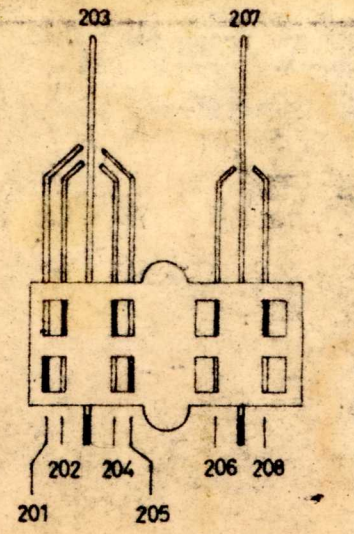
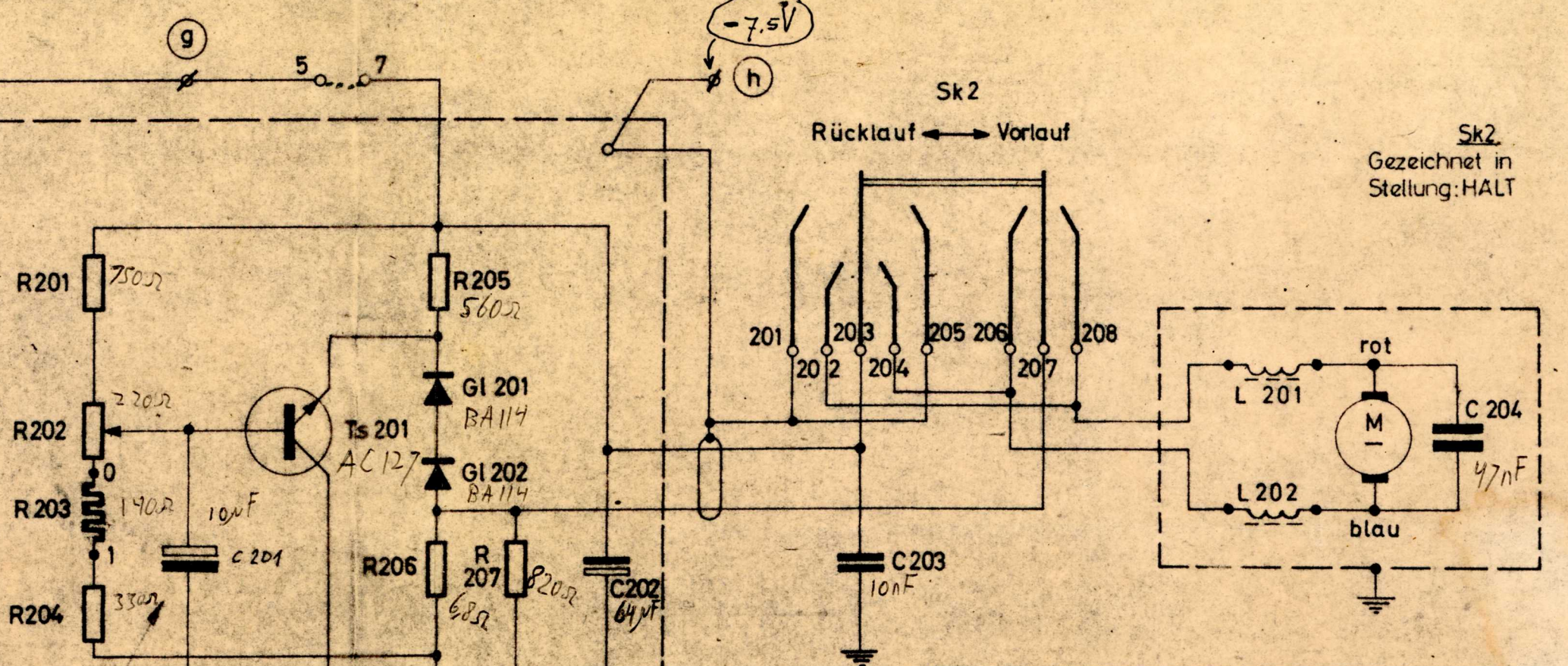
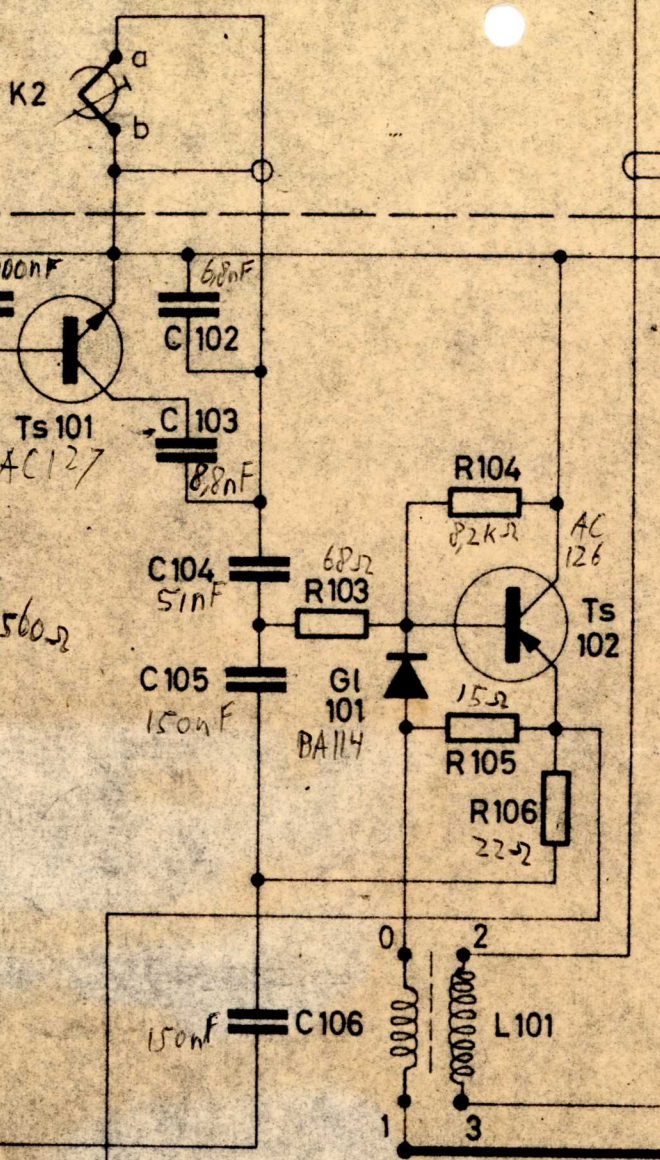
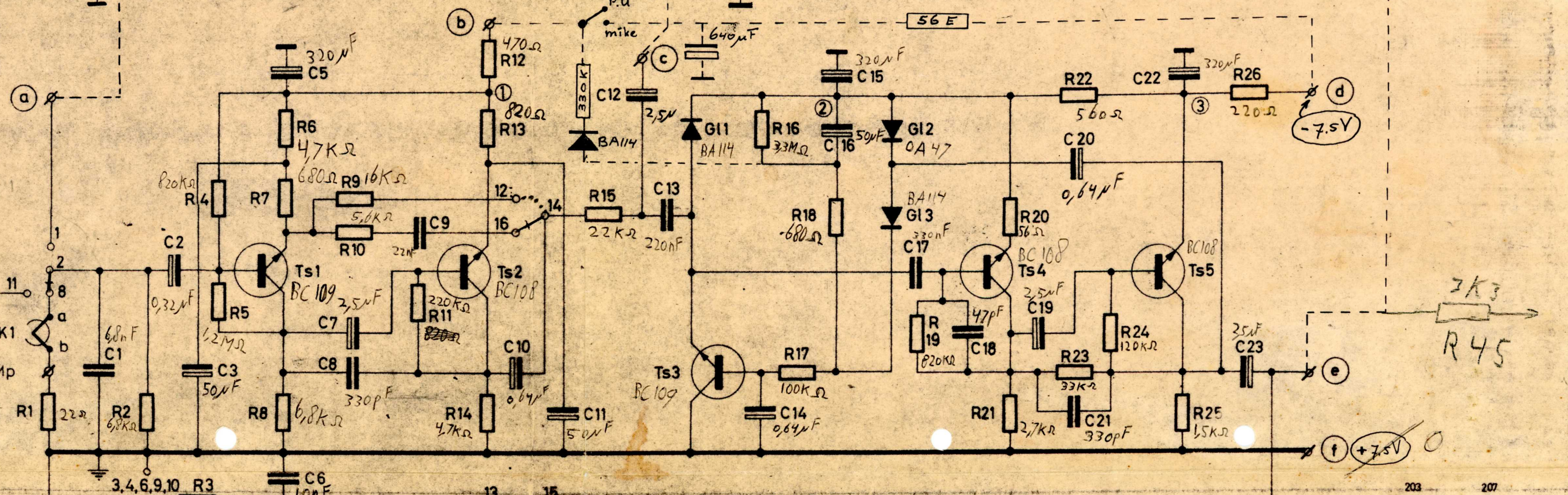

Sk2 Gezeichnet in Stellung: HALT

ROUGHNESS RAUHEIT	SCALE MASST.	UNIT EINH.	PROJ. EUROP.	STAND D 28	h4, h6, h7, h9, h11 F8, G4, G7, H4, H6, P7, NORM.	STAND D 17	M... G... W...	STAND D 12 D 15 D 9 D 6	STAND D 23 D 24 D 25	STAND D 26	
ASSEMBLY NO. ZUSAM. NR.	PATTERN NO.	QUAL. STOCK	MOBIL. NR.	CHASSIS, 2 US.							3103 209 050A



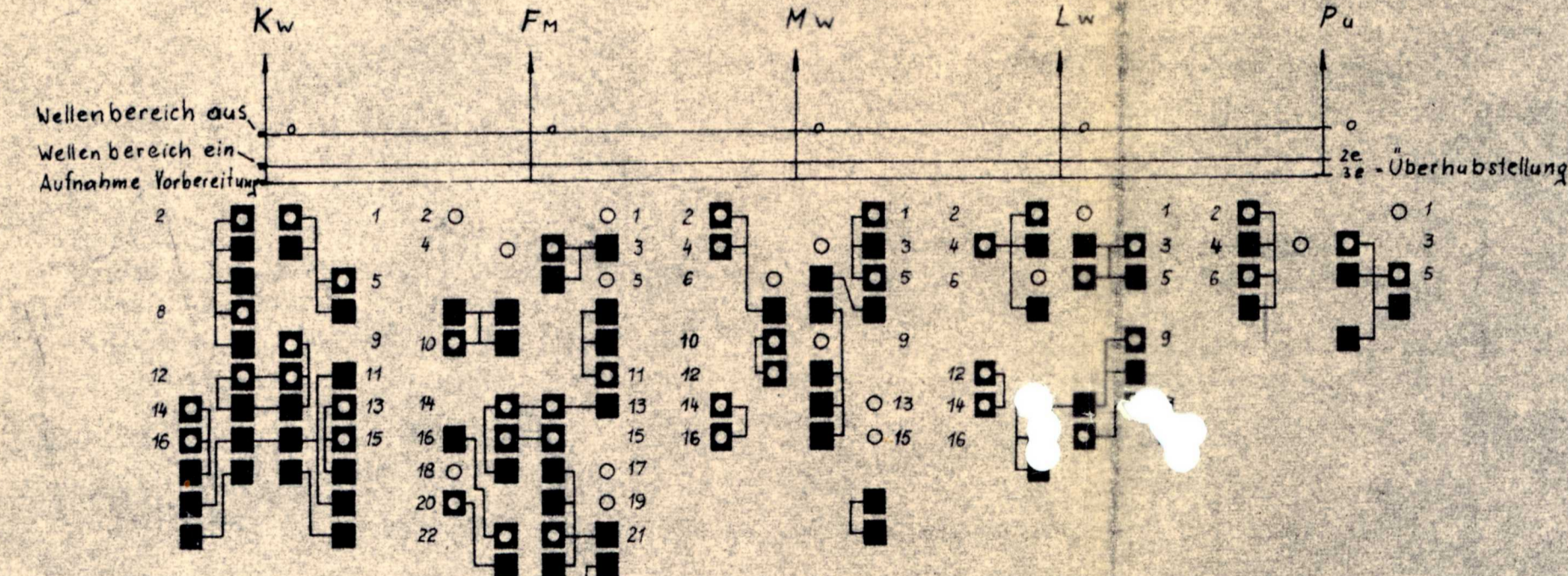
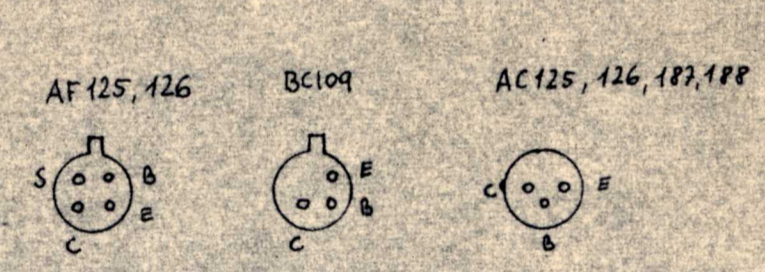
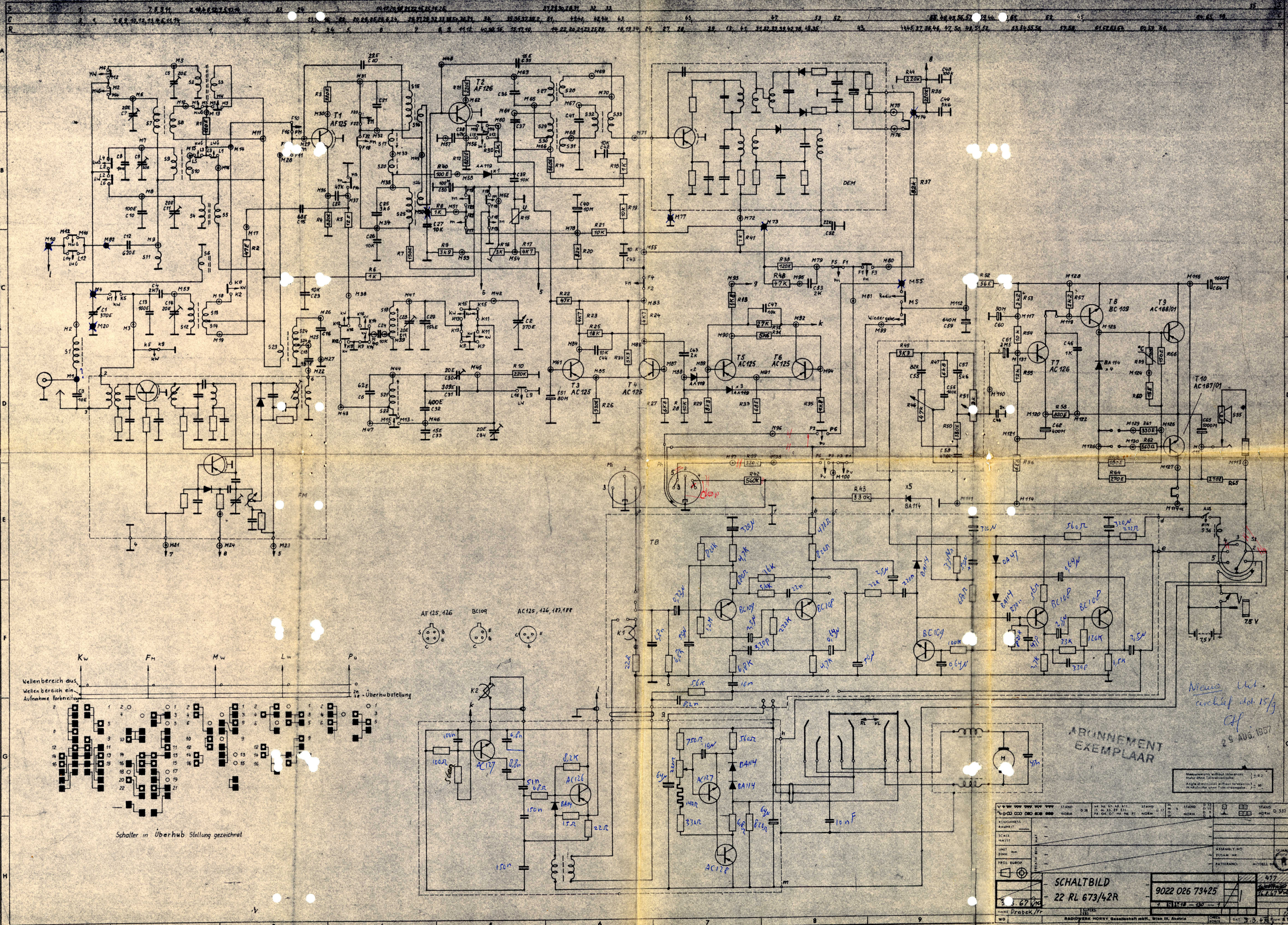

Schalter in Überhub Stellung gezeichnet

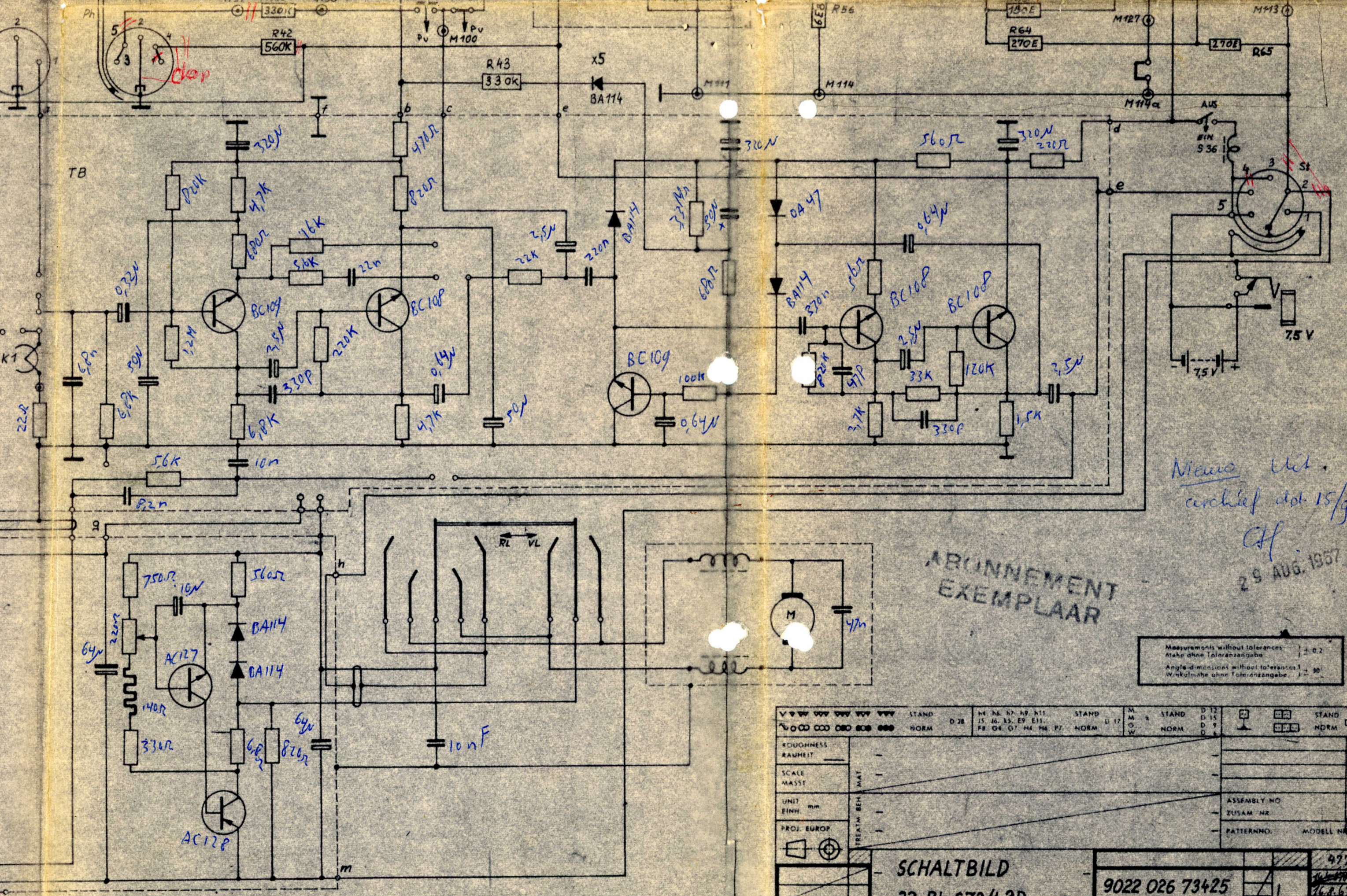

Neues Netz  
erschließ. ab 15/9  
Gf  
29. AUG. 1957

ABONNEMENT  
EXEMPLAAR

Measuring points without tolerance  
Make about tolerances  
Angle dimensions without tolerance  
Welding in the upper tolerance range

STAND	D 28	STAND	D 17	STAND	D 11	STAND	D 533
REVISIONS		REVISIONS		REVISIONS		REVISIONS	
SCALE		SCALE		SCALE		SCALE	
UNIT		UNIT		UNIT		UNIT	
PROJ. EUROPE		PROJ. EUROPE		PROJ. EUROPE		PROJ. EUROPE	
SCHALTBILD				9022 026 73425			
22 RL 673/42R				3.67			
NAME Drabek/Fr				DATE 3.3.64			

13 00  
145  
106  
178  
301  
376  
540

7



601	602	701	702	2		503	502	504	505	501																					
11	K	H	B	6																											
18 23 53	26 20 15 22	4 28 14 29	24 33 25 7 50 34 40	12 27 32 6 38	31 5 39 30	35 51	37 39 29 33 30 32	46 58 57	56 55 61	59 62 65 64	60	45																			
38 6 37	48 2 19 21	4 20 3 8 5	7	1 40	21	10 14 9																									
S					601		516	506	522	515	514	517	513	518	511	512	510	508	521	519	507	520	509	523	503	508	504	501	502	506	C
R					602 603 601 604	606 605	607 702					516	518	526	517 522	520 511 519 515	514 521 509 523	506 513 524 510 504 525 507	503	508	502	505 501	R								
					603 601 604 606 605 602		705 707 706 703 704 702 701																								

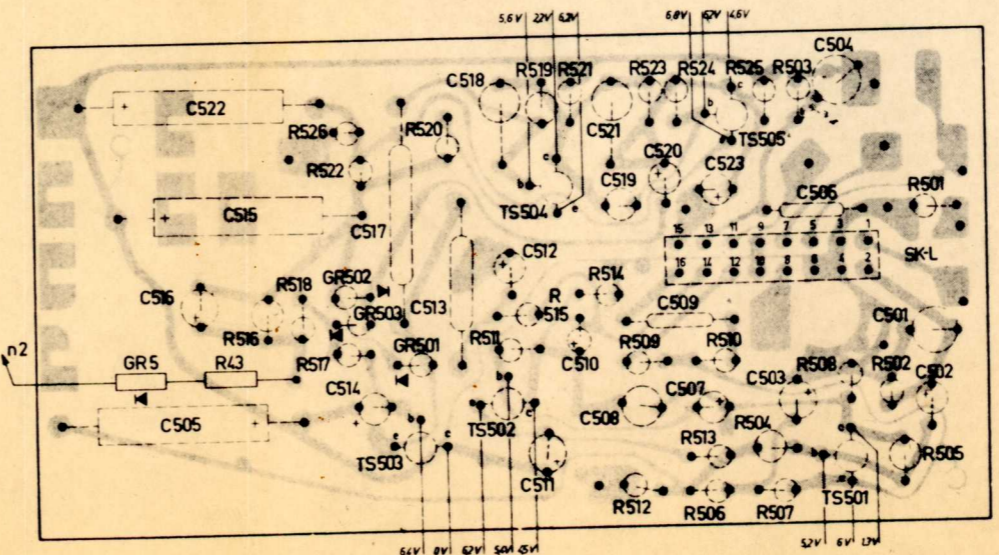
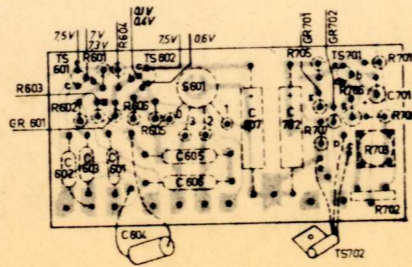
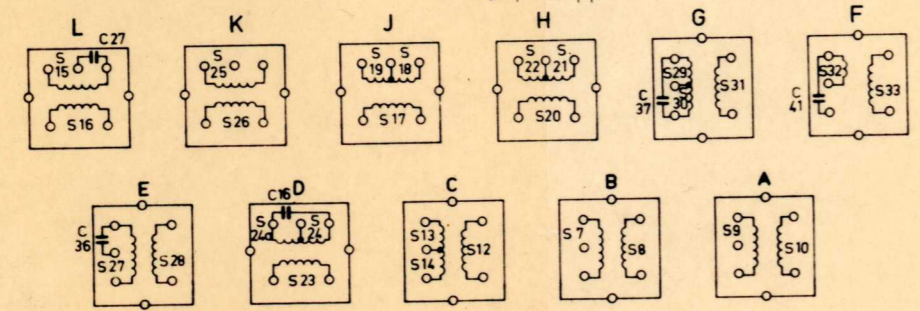
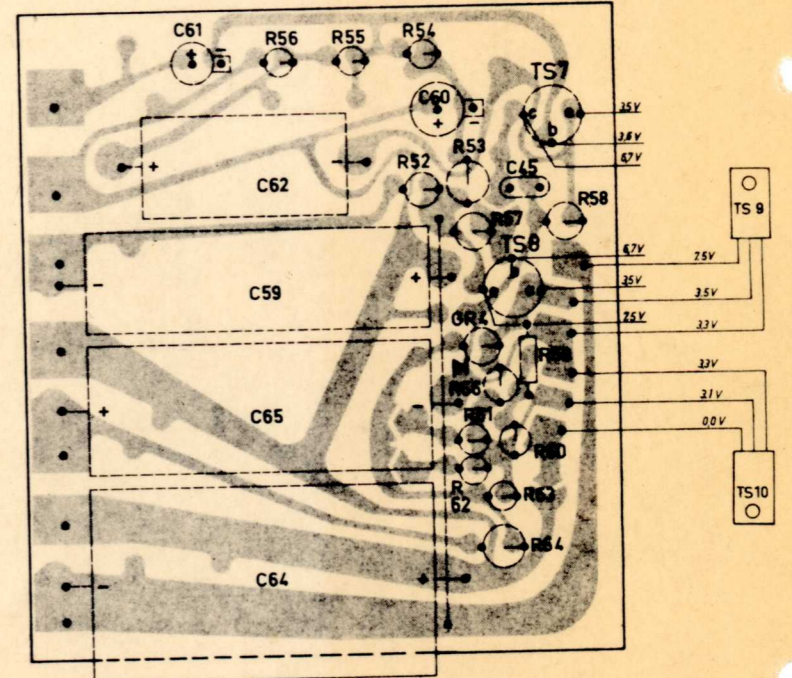
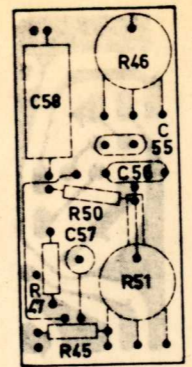
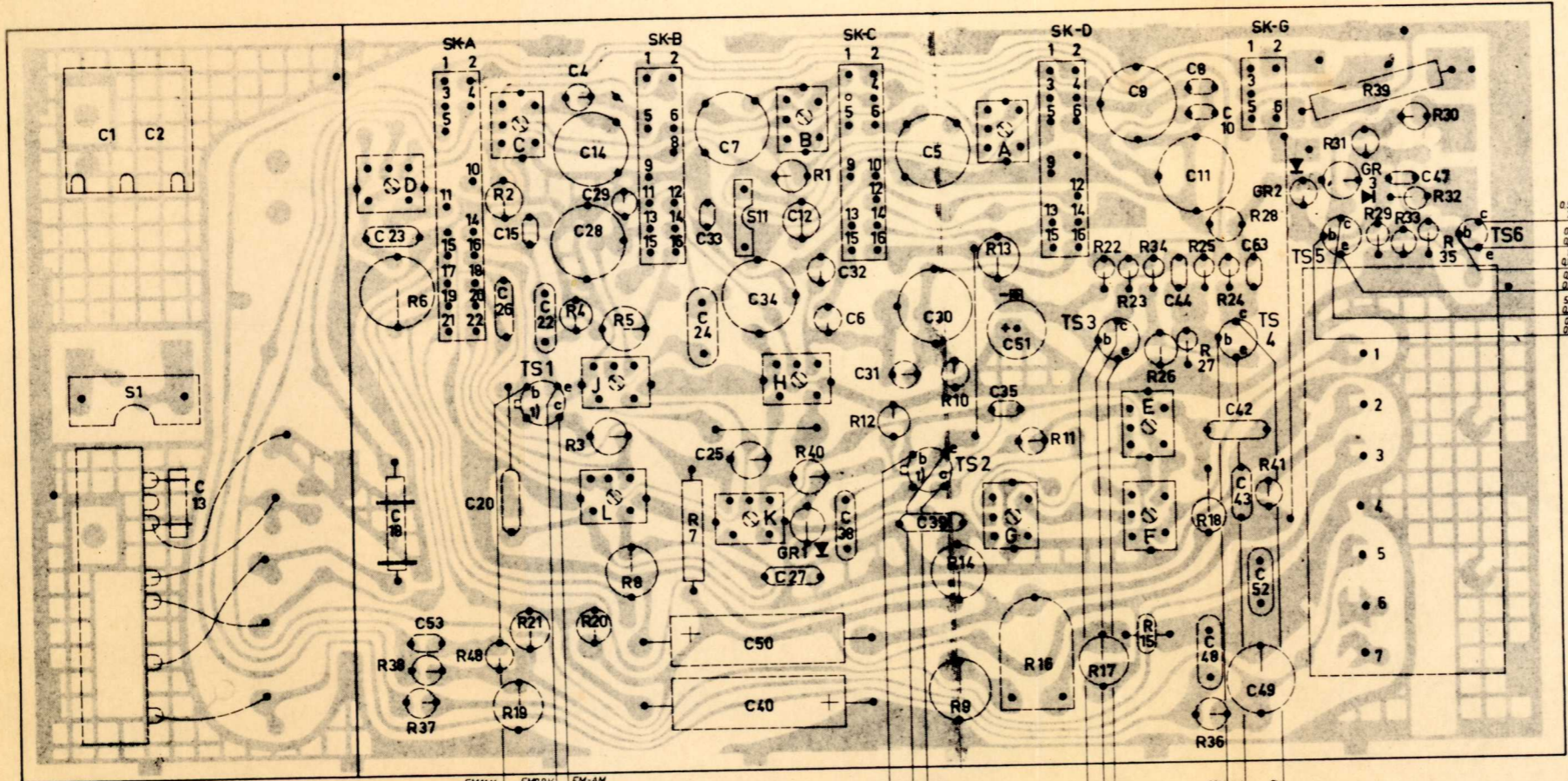

TRA 2797