

Technisch
VADEMECUM

Afdeling

E-R

ELECTRO- EN RADIOTECHNIEK

onder redactie van

Ir G. L. LUDOLPH

*Directeur van de M.T.S. te
Haarlem*

TWEEDE HERZIENE DRUK



N.V. DE TECHNISCHE UITGEVERIJ H. STAM

Haarlem — Antwerpen — Djakarta

- U_L = spanning op het fluorescerende scherm van kathodestraalindicatorbuizen
 α = verlichte hoek in graden ($^{\circ}$) van het fluorescerende scherm
 β = donkere gedeelte in graden ($^{\circ}$) van het fluorescerende scherm
 V_u = versterking van de buis (spanningsversterking)

I. HULSTYPEN

Door het grote aantal soorten radiobuizen is ook een groot aantal hulsvormen noodzakelijk geworden. In boekjes met gegevens van de radiobuizen is steeds aangegeven van welk type huls de buis voorzien is. De voornaamste typen zijn:

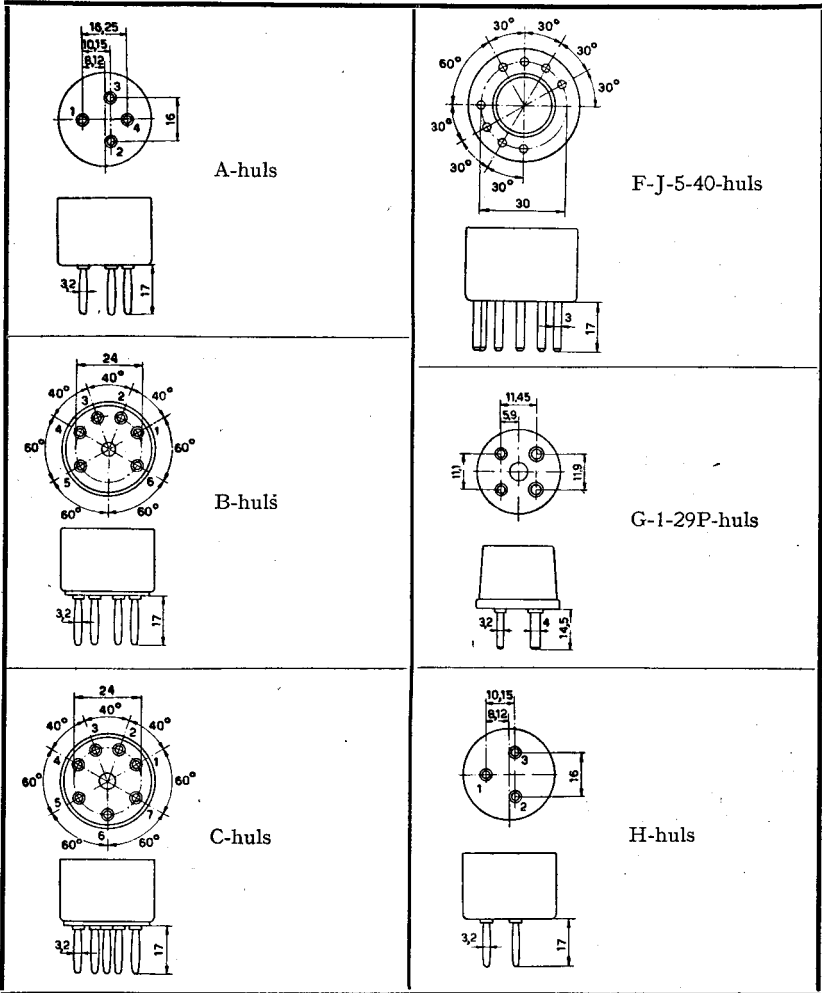

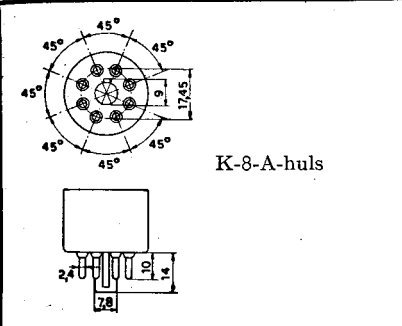

K-8-A-huls

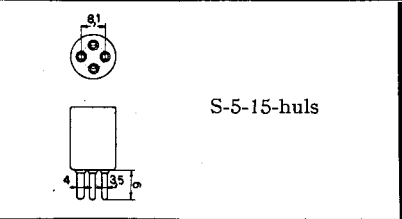

S-5-15-huls

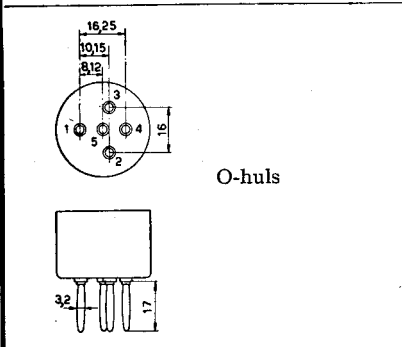

O-huls

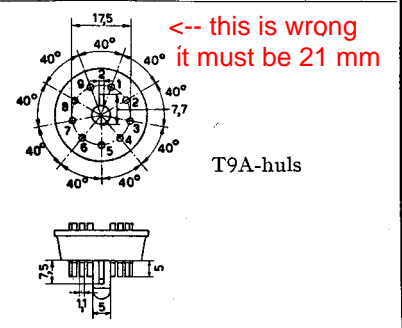

T9A-huls

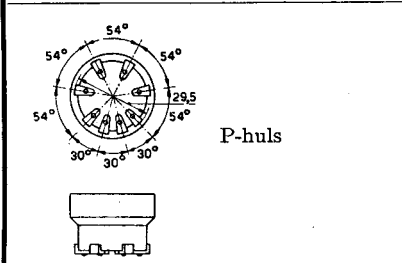

P-huls

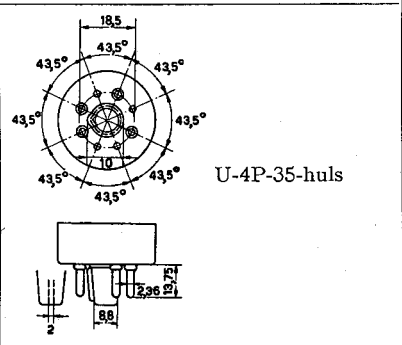

U-4P-35-huls

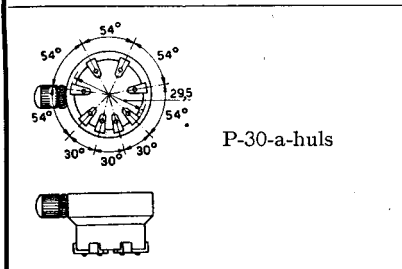

P-30-a-huls

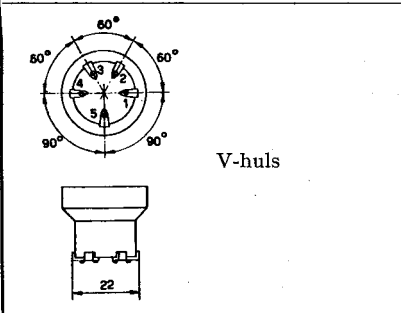

V-huls

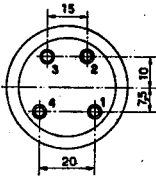

W-huls

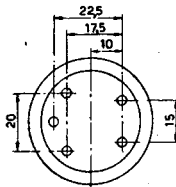
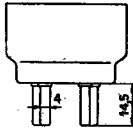

W-E-5-42-huls

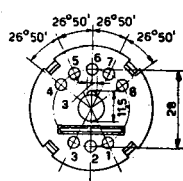
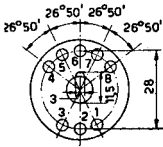
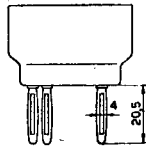

huls type
6278525.4

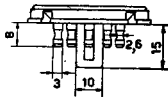
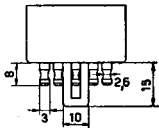

twee uitvoeringen van de huls Y 8 A

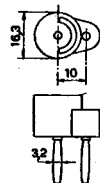

Y-10-16 huls

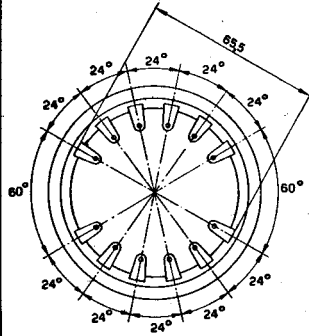

Z12A
huls

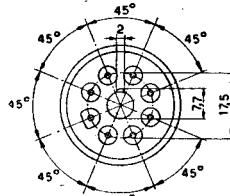
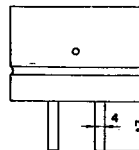
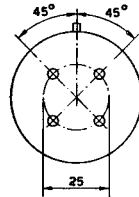
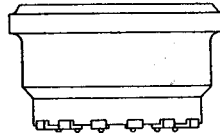

W8A-huls
voor
sleutelbuizen

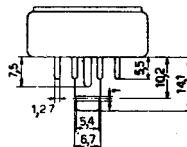

J. AANSLUITINGEN BUISVOETFN

Op blz. 585...604 is de juiste aansluiting van een buisvoet te vinden. Ter vergemakkelijking zij eerst verwezen naar het alfabetisch register, waarin men het verlangde typenummer van de buis kan vinden.

Voor afwijkende aansluitingen is een cirkeltje i.p.v. een zwarte stip getekend; naast het cirkeltje staat de electrode vermeld.

A - voet .

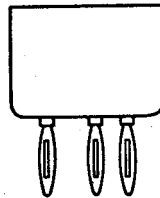
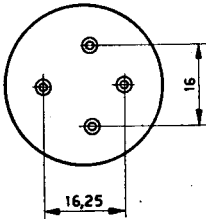
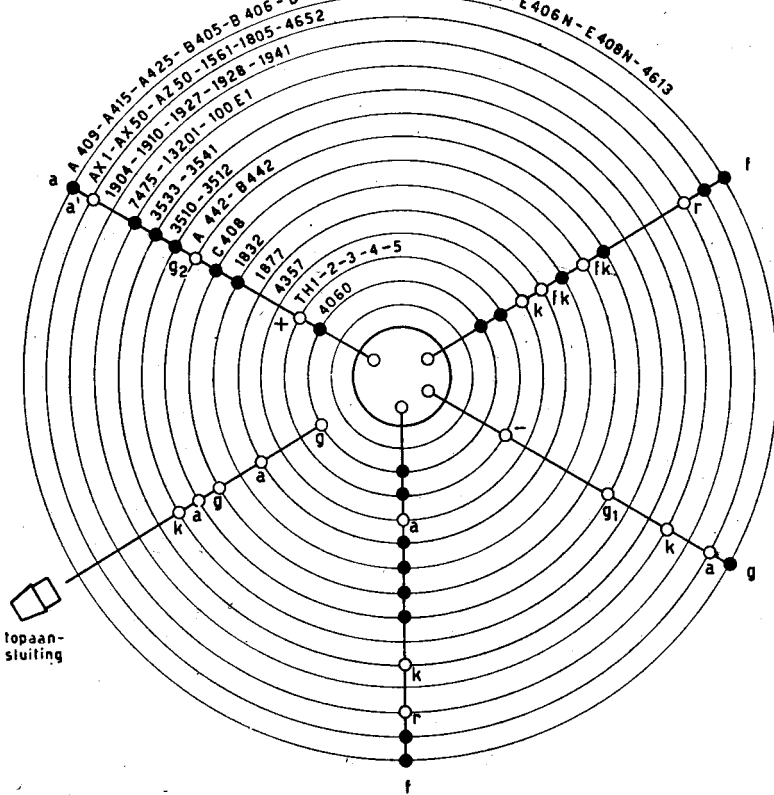

B-voet

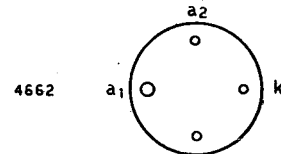
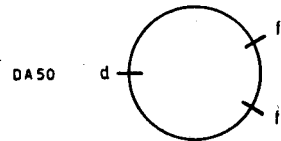
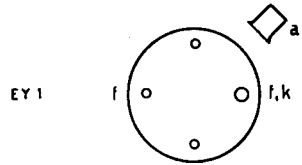
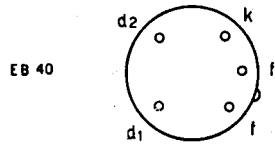
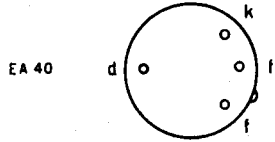
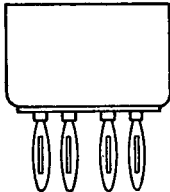
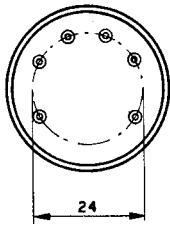
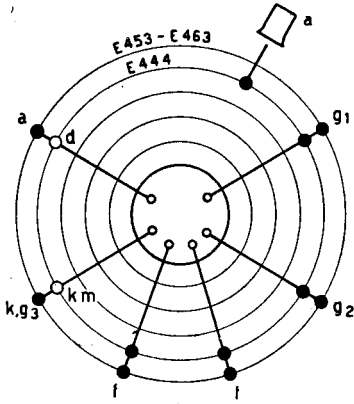

C - voet

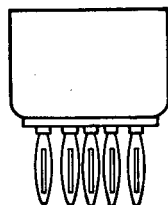
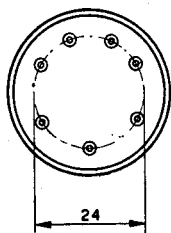
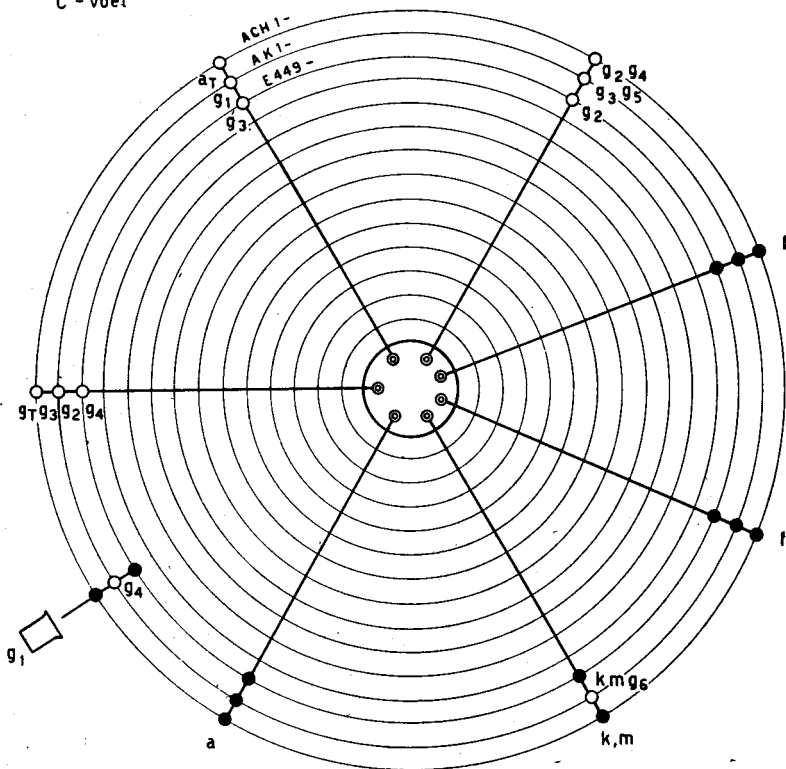

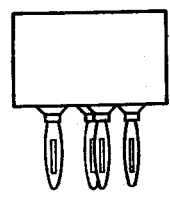
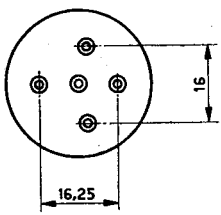
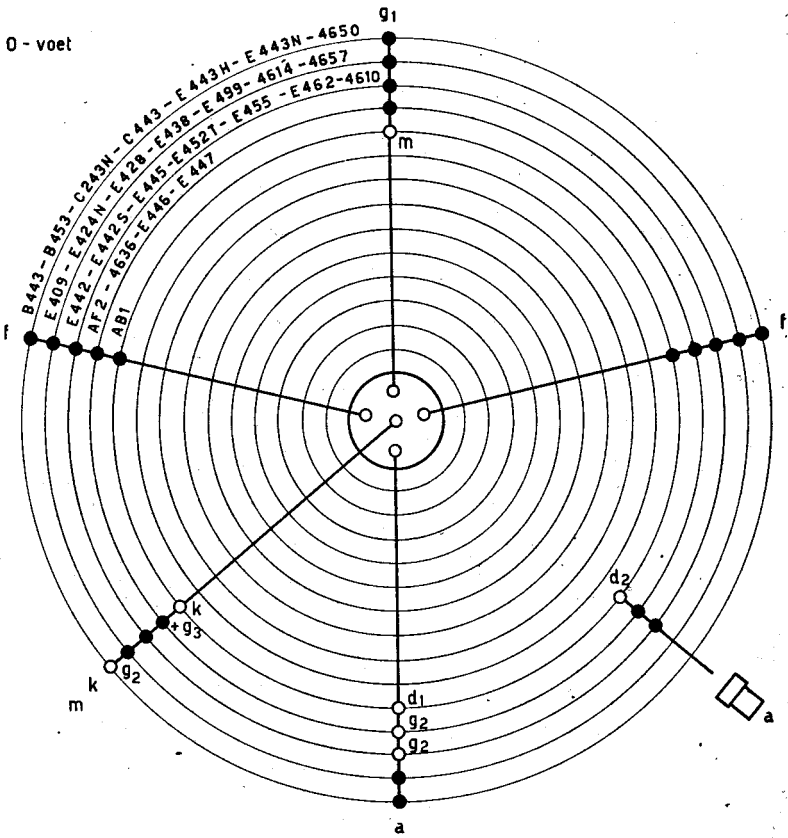

P-voel
bl.1

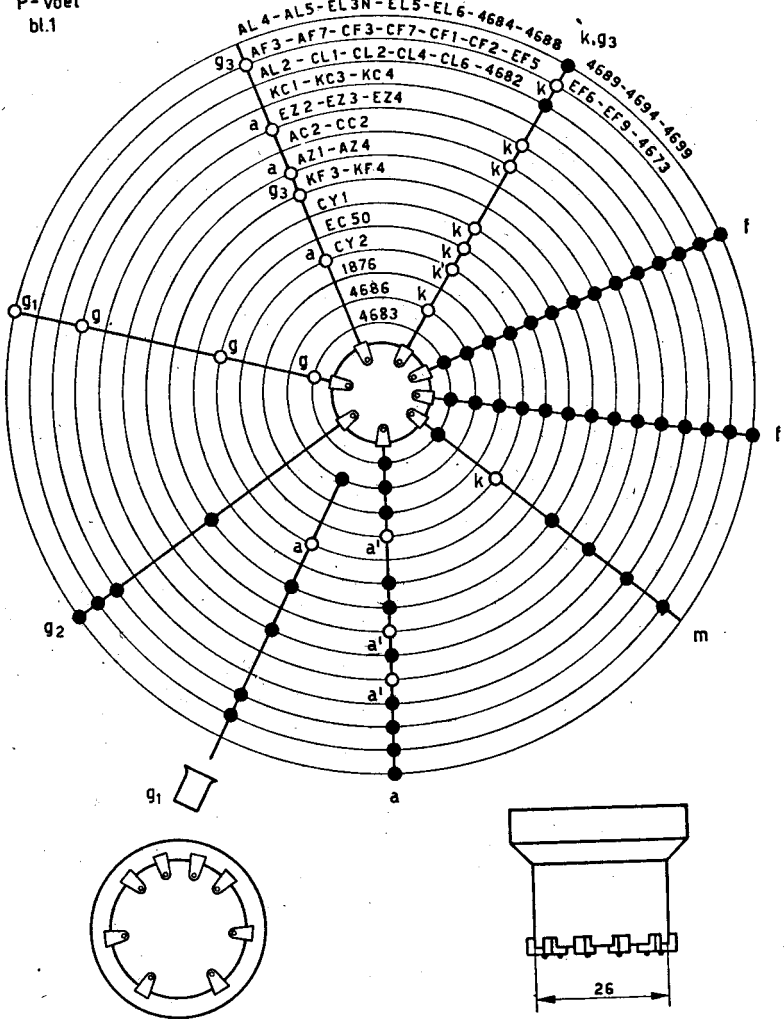

P-voet
bl. 2

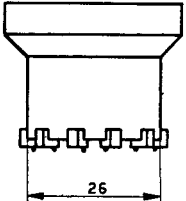
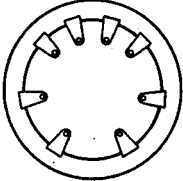
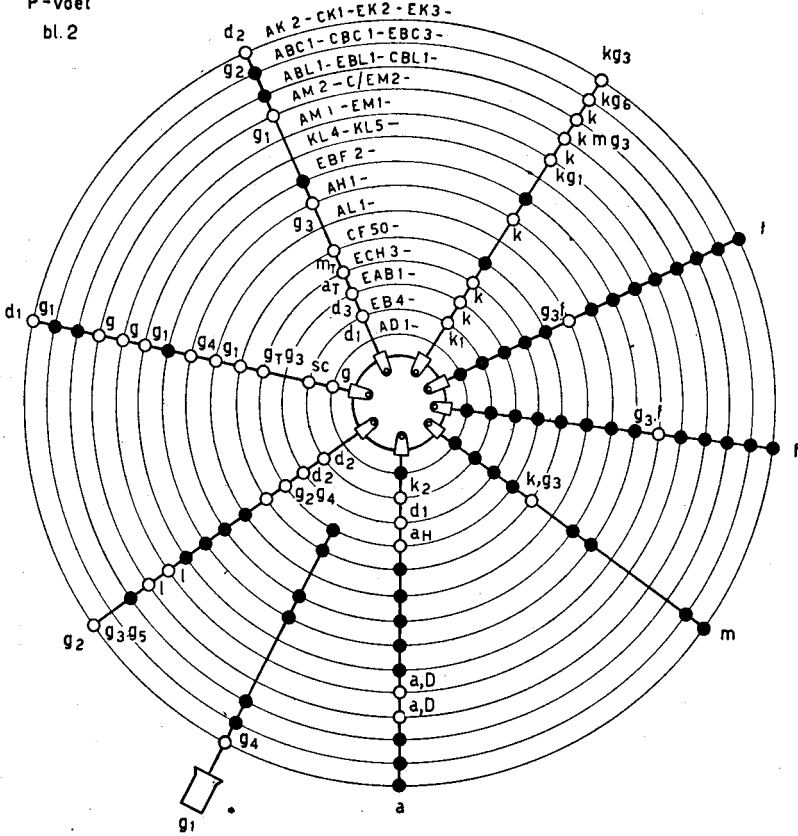

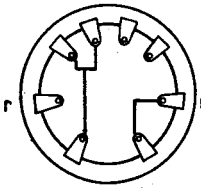
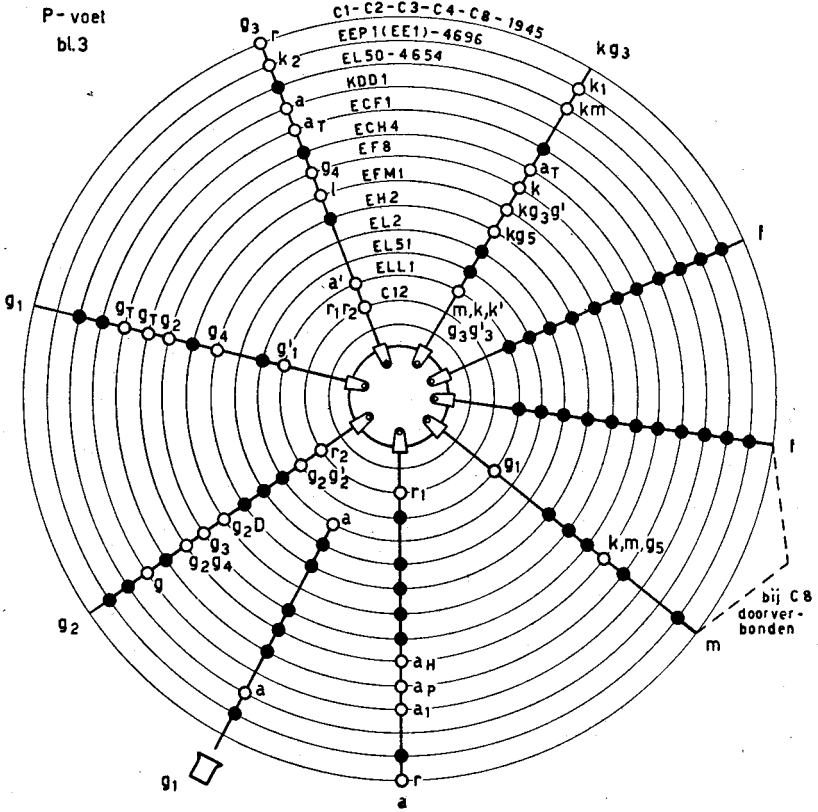

C9

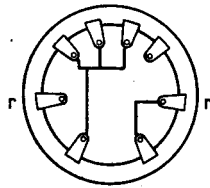

C10

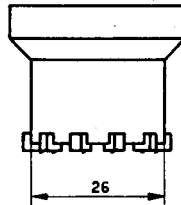

P-voet
bl.4

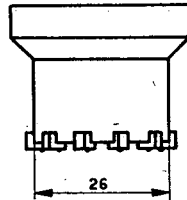
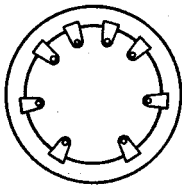
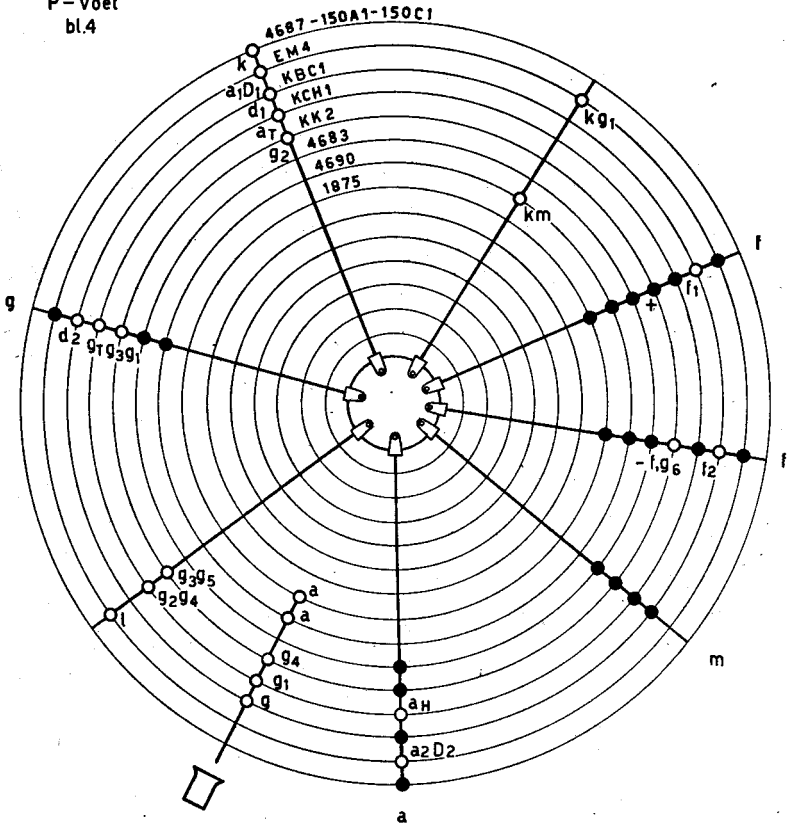

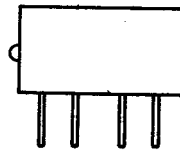
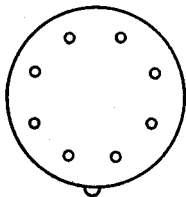
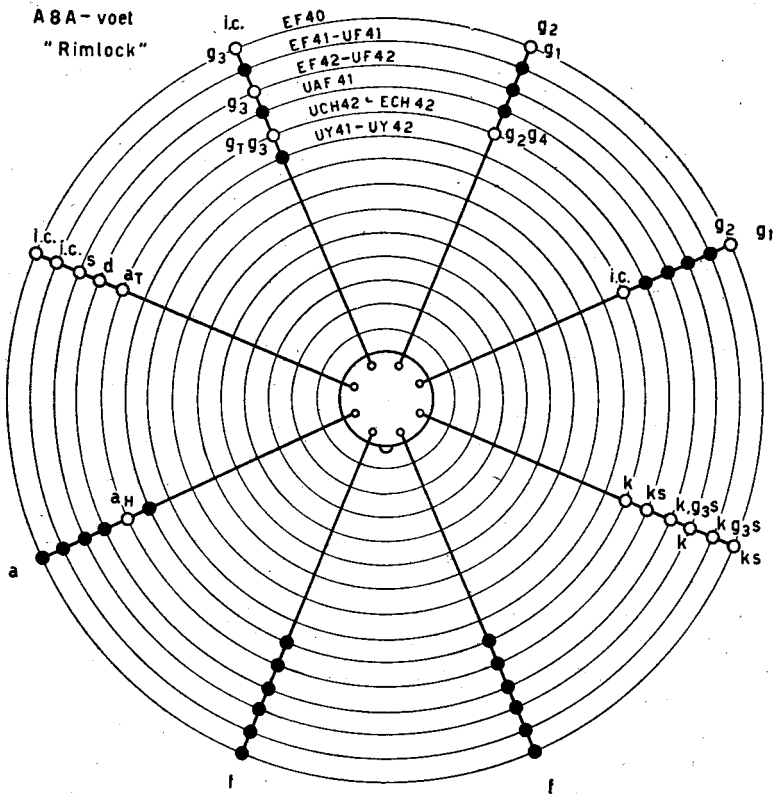

A 8 A - voet
"Rimlock"

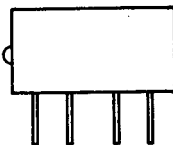
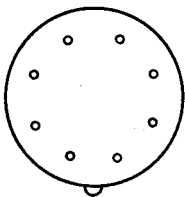
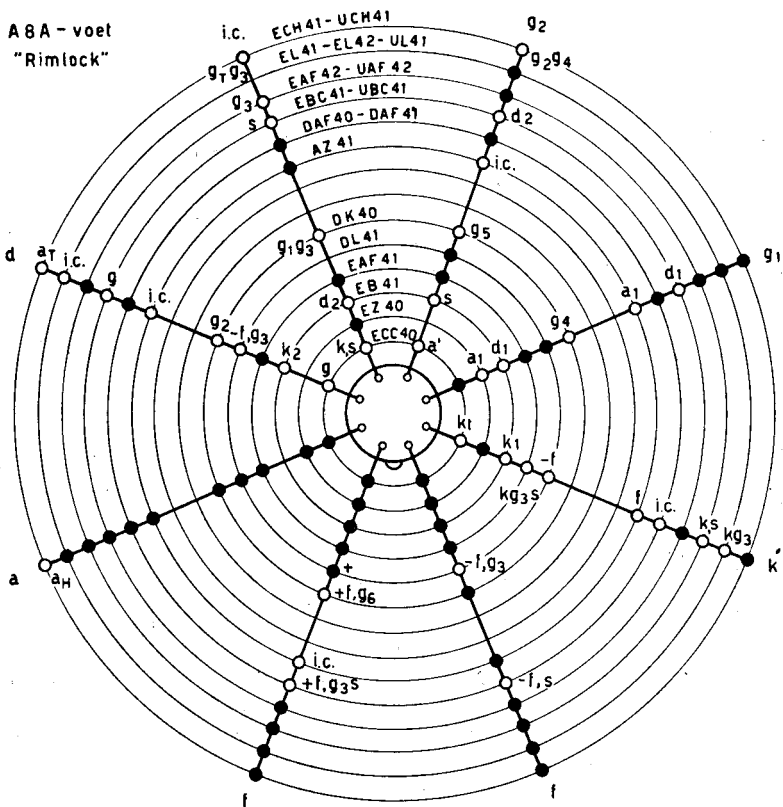

K8A - voet
bl.1

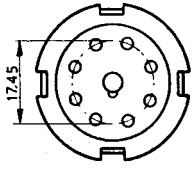
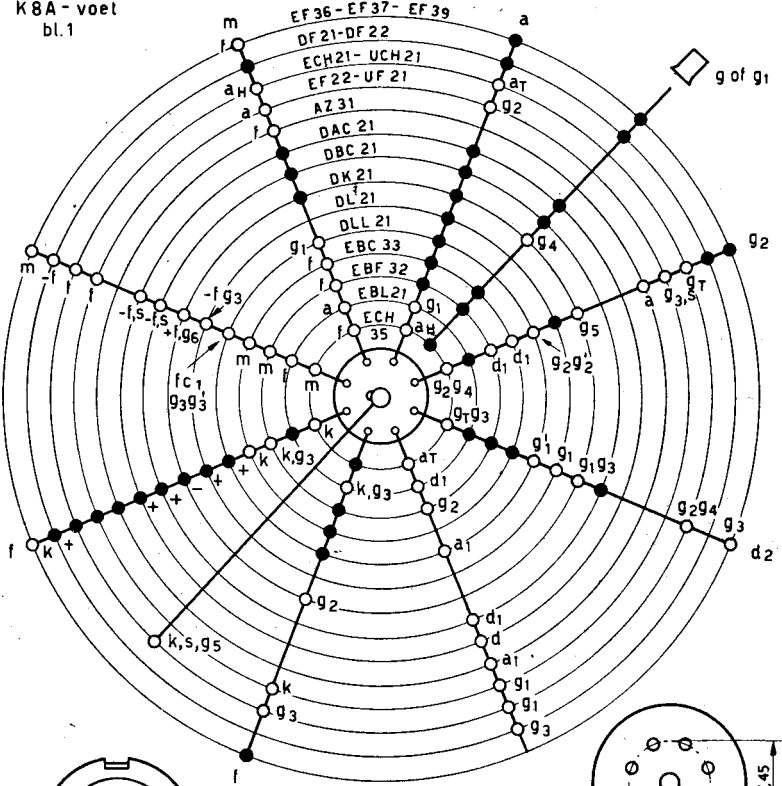

metaal

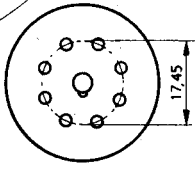

glas

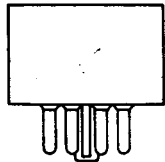
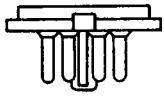

T9A - voet
C2R - voet

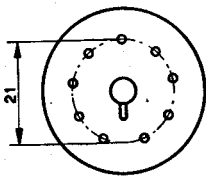
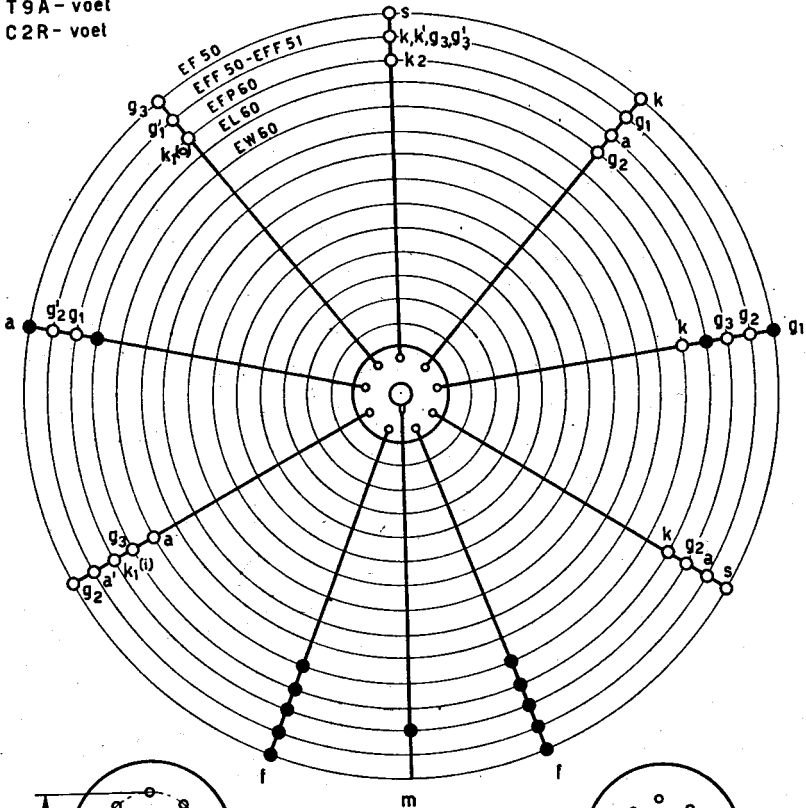

T9A - voet

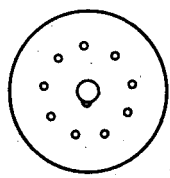

C2R - voet

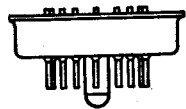

e.g. EF50 EFF50

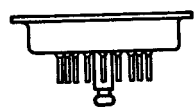

e.g. EFF51

pin circle diameter is 21 mm for both,
the keying pin is different

Y 8 A - voet

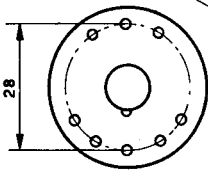
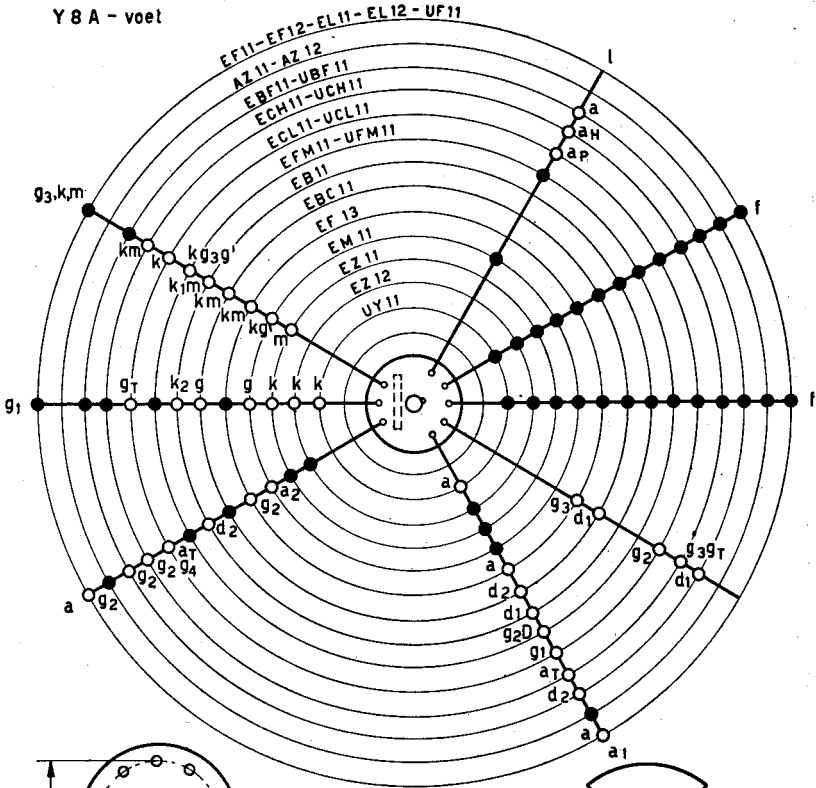

glas

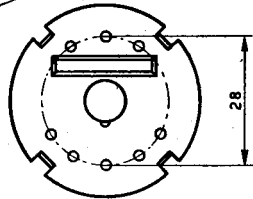
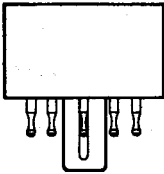

metaal

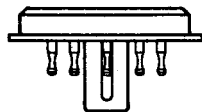

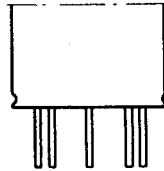
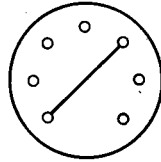
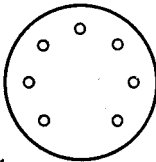
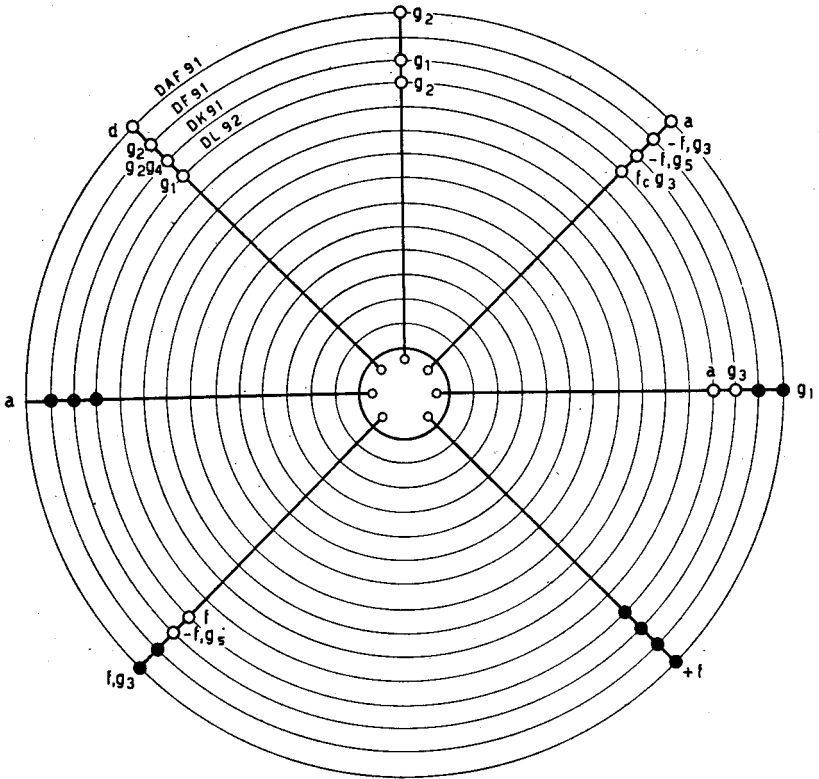

doorverbonden
bij DF 91 en DK 91

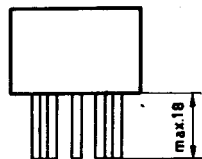
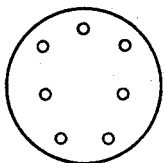
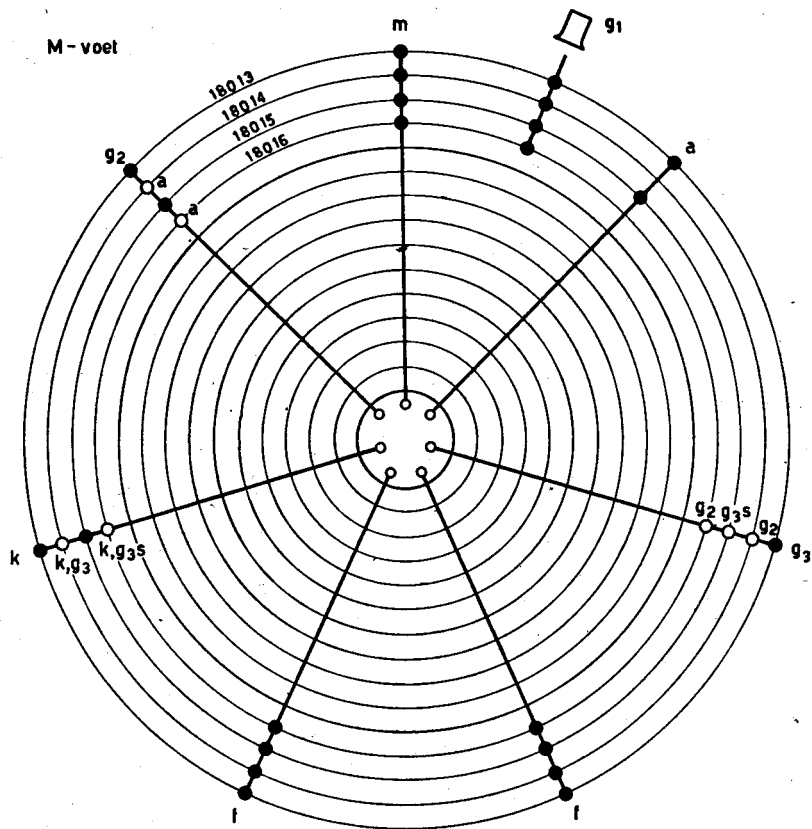

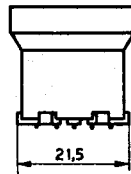
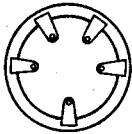
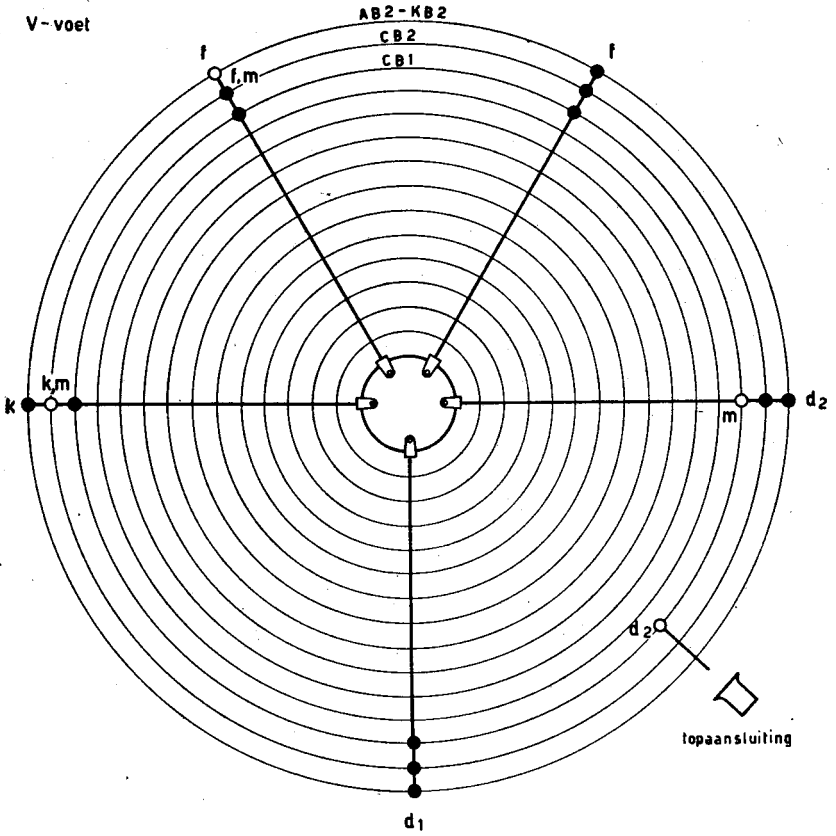

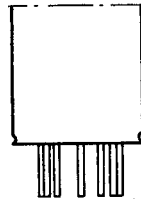
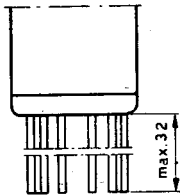
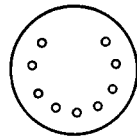
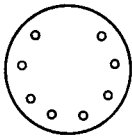
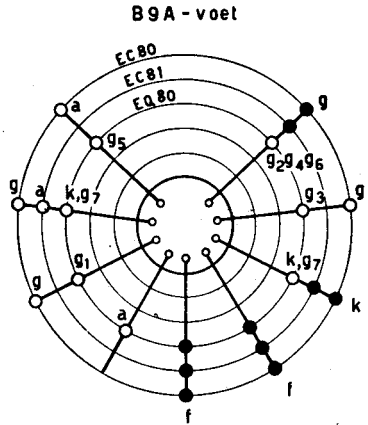
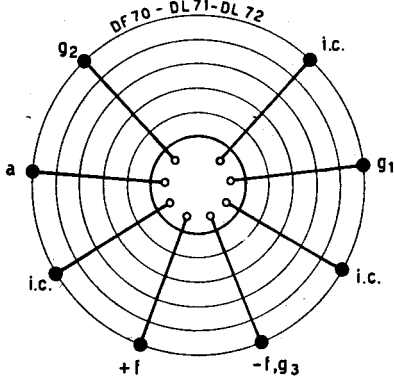

USM 4B - voet

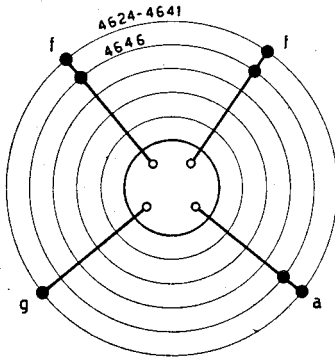

G 4 b - voet

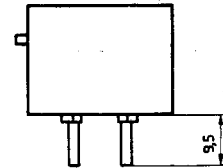
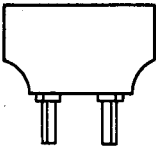
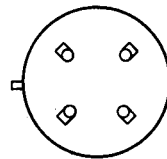
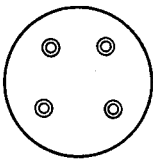
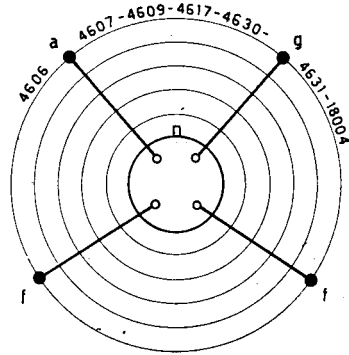

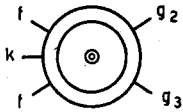
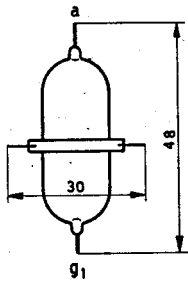

E 1 F
4672
4676
4695

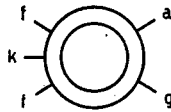
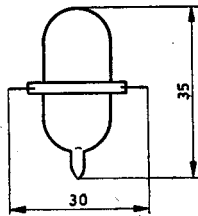

E 1 C
4671
4675



EY 51

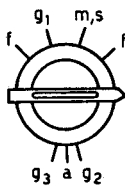

D 1 F
D 2 F

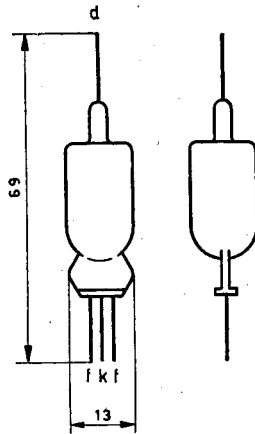
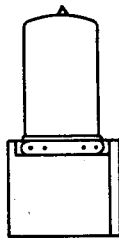

EA 50
4623

Verder zijn er nog een aantal buizen, die zonder huls geleverd worden, zoals de *knoop-buizen*, ook wel *eikelbuizen* genoemd. De afmetingen van deze speciale buisvormen volgen hieronder (zie ook blz. 604):

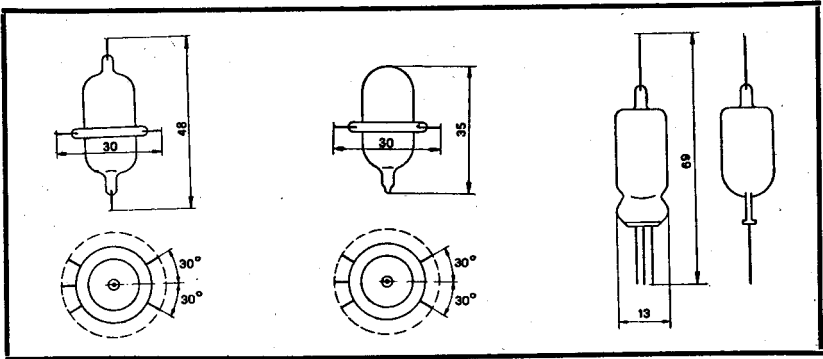

Amerikaanse hulzen

In Amerika maakt men thans vrijwel uitsluitend gebruik van de „kleine octal” huls. Deze heeft het voordeel, dat de verschillende uitvoeringen ervan allen in dezelfde buishouder passen. Men heeft vijf verschillende uitvoeringen (met 5 tot en met 8 pennen); om verkeerde plaatsing in de buishouder te voorkomen is de huls voorzien van een „steutel”. De hoofdafmetingen blijken uit fig. R 103.

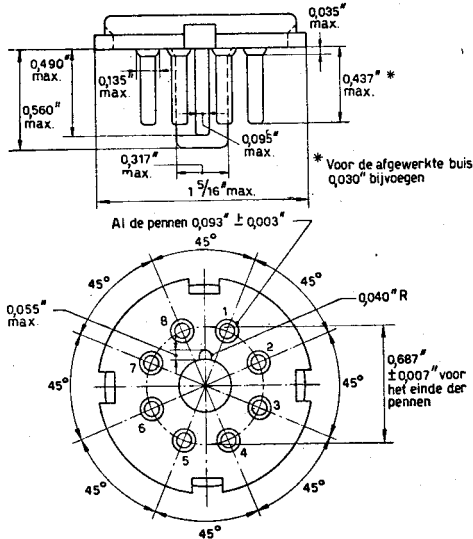

Fig. R 103