

Sylvania Electroluminescent Display Devices

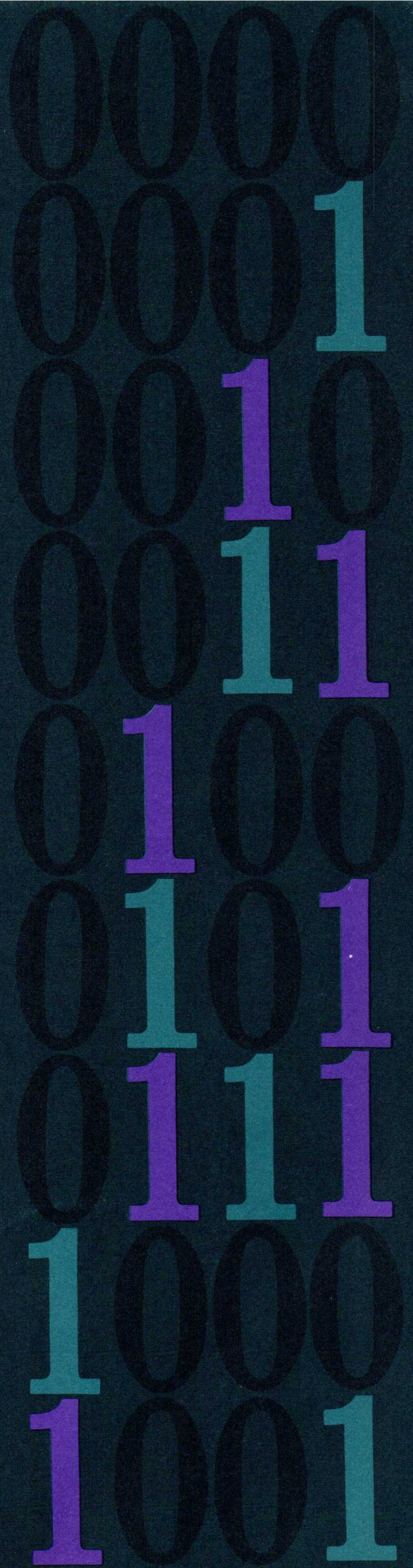

Sylvania
electroluminescent
display
devices

OFFERING:

NEW TECHNIQUES FOR...

- Visual Readout of Alpha-Numerics • Information Storage and Memory • Performing Complex Logic Functions • Image Conversion

FEATURING...

- Reliability • Compactness through Flat Construction • Unusually Low Power Requirements • Cool Operation • Elimination of Parallax in Readout • Simplified Circuitry • Use of Standard Printed-Circuit Connectors

PROMISING...

- Outstanding Possibilities for Miniaturization • Significant Cost-Reductions in Logic Circuitry

IN SUCH EQUIPMENT AS...

- Electronic Computers • Digital Voltmeters • Cash Registers • Status Boards • Tactical Displays • Circuit Alarms • Counters of Many Types

All devices described in this booklet are *immediately* available for immediate application to meet your specific requirements.

The conversion of electricity into light within a phosphor is called electroluminescence. Although this physical phenomena had been known for some time, it was considered to have limited application. However, Sylvania engineers recognized one major advantage of electroluminescence as a lighting source. *A planar or area solid state device, with no filament or vacuum, minimizes catastrophic or "sudden death" failure.*

electroluminescence

In 1950, Sylvania Electric developed for commercial application a light producing element employing electroluminescence known as a "Panescent®" lamp. Sylvania's Lighting Division is currently mass producing "Panescent" lamps for aircraft, instrument panels, car dashboard panels, electric clock dials and highway road signs. A Sylvania "nite lite", operating on standard household voltages, has recently been put on the market for consumer usage. It is conceivable in the future that entire walls and ceilings will be made up of "Panescent" lighting.

"Panescent" lamps are only one application of electroluminescence. Of major importance to Electronic Design Engineers are these uses of electroluminescence:

DISPLAY DEVICES
PHOTOCONDUCTION
SWITCHING
INFORMATION CONVERSION
LOGIC SYSTEMS
STORAGE AND MEMORY DEVICES

In order to understand electroluminescence and its practical application within the areas mentioned, it is desirable to carefully examine the physical properties and characteristics.

ELECTROLUMINESCENT LAMPS The electroluminescent lamp (Figure 1) is a flat plate luminous capacitor activated by an alternating current. It may be manufactured on either a glass base sheet, or a metal base. The glass base sheet usually requires the application of a thin transparent conductive film. The next layer contains the electroluminescent phosphor imbedded in a ceramic dielectric. The use of a ceramic material offers complete protection against moisture. Finally the top conductor is applied using either a transparent conductive film or a metallic film, depending upon the application.

Essentially, the lamp is completed with the foregoing construction. The sum of the thickness of all the coatings applied to the glass backing is less than .01 inches. Where a thicker insulating coating is desirable, the lamp may be imbedded in clear plastic, such as the acrylic plastics.

The brightness of these lamps, determined mainly by the electrical field strength across the electroluminescent layer and the frequency of the power supply is shown graphically for a typical lamp in Figure 2.

DISPLAY DEVICES It was recognized, soon after the development of the practical electroluminescent lamp, that this new light source could be employed to create dynamic solid state panel display devices.

The display devices under consideration include modifications of the electroluminescent panel which has been described previously as a light source.

It should be pointed out that light is emitted where, and only where, there is capacitive coupling. Thus, by patterning the top or bottom conductive films in given areas, it is possible to arrive at any shape, configuration or group of areas that are capable of lighting individually or in unison. The size and separation of the lighted elements can readily be made smaller

than arrays of other light sources, such as incandescent lamps or glow lamps.

MULTI-ELEMENT DISPLAY By patterning the top and bottom conductive films in parallel grid lines at right angles to each other or in any continuous curve, a crossed grid results known as an X-Y panel. (Figure 3)

If a potential is applied to one line in the X direction and one in the Y direction, a bright spot of light results where the grids cross. This potential also causes one-half the voltage to be applied to the entire row and column, which results in a "cross" effect. That is, each line will emit some light along its entire length due to the voltage division. However, the intersection of the grid lines results in a square of light which is considerably brighter. This effect is very useful if the displays are used with a coordinate index such as mapping. In some applications, however, this cross effect is objectionable and may be suppressed by the incorporation of a non-linear resistive layer. A single bright point is the result of the highly non-linear voltage-brightness characteristic of this resistor-electroluminescence combination.

This display has several positive advantages over other commercially available display devices. First, it is all on the same plane and consists of a series of thin coatings on glass resulting in minimum depth requirements. Secondly, by the use of flag contacts, as shown in Figure 4, the panels may be contacted by printed circuit connectors.

MULTI-SYMBOL DISPLAY *Sylvania's numeric and alpha-numeric panels*, either singly or in groups, are capable of forming numbers, letters of the alphabet, several foreign language characters, plus and minus signs and punctuation. Some of the many potential applications for these devices are computer readouts, instruments, cash registers, amusement machines and score boards.

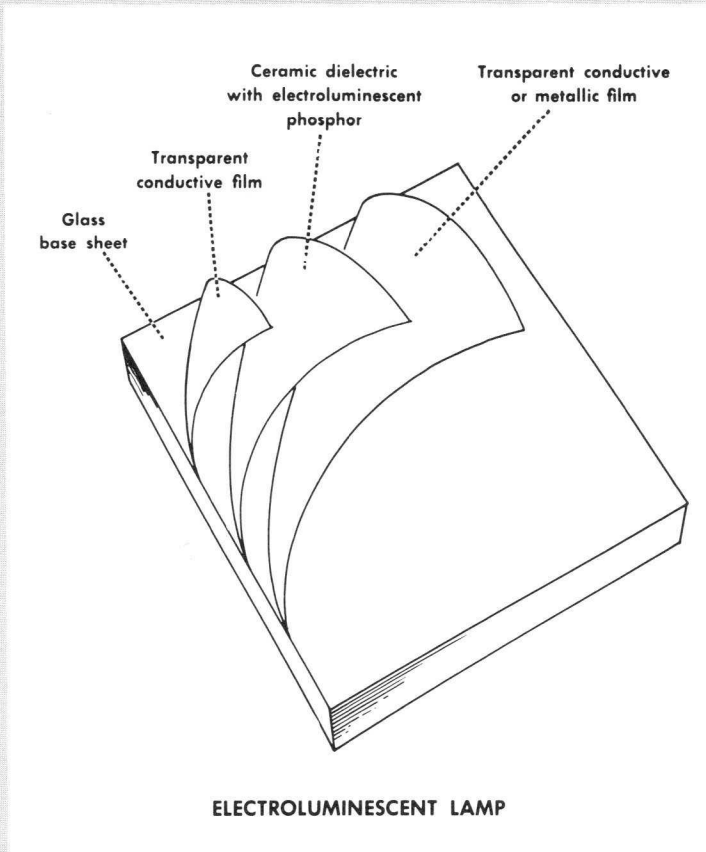

FIGURE 1

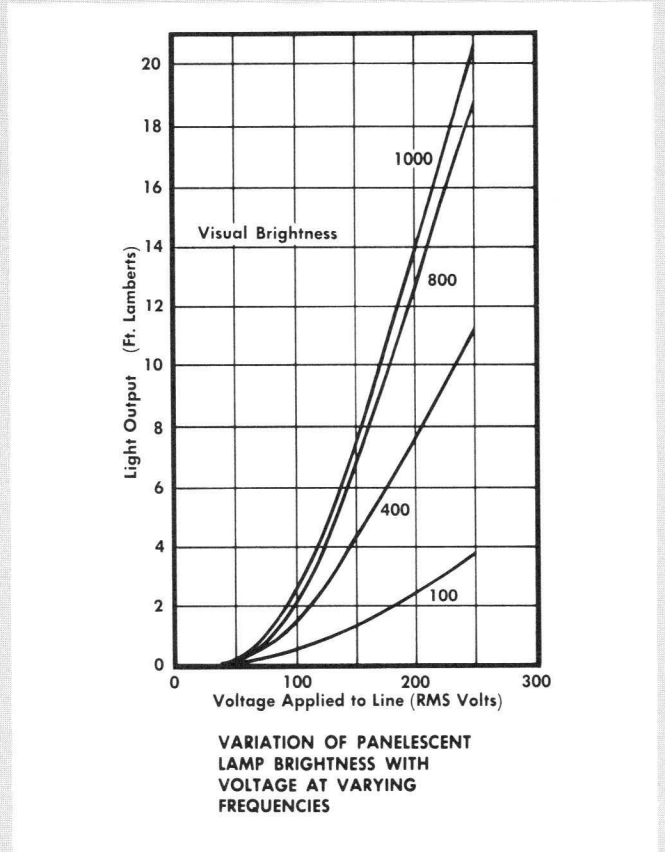

FIGURE 2

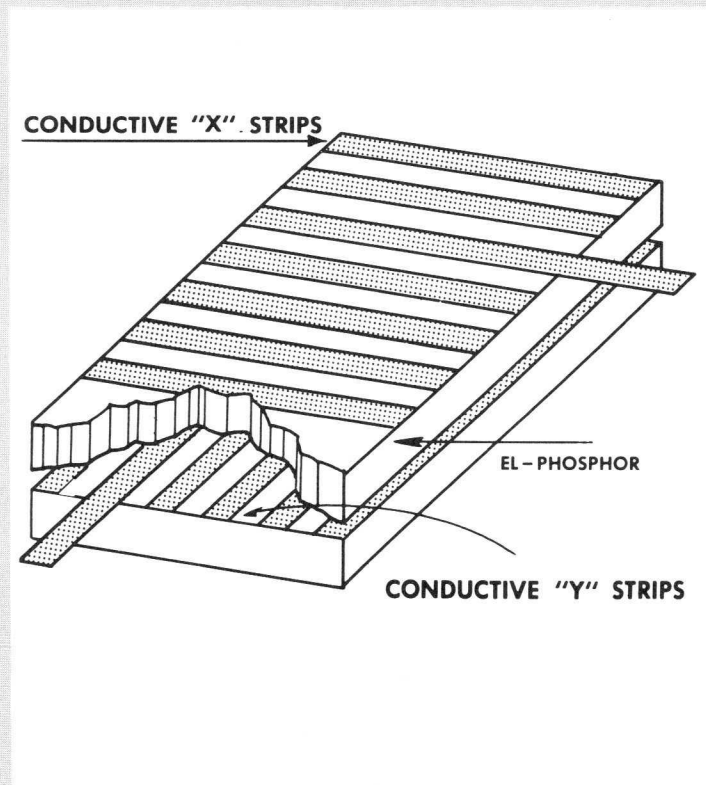

FIGURE 3

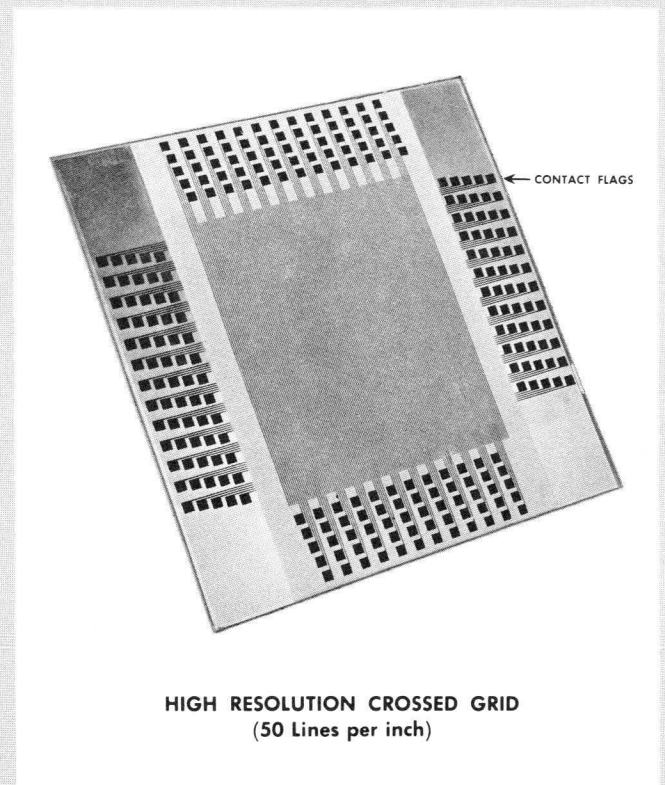

FIGURE 4

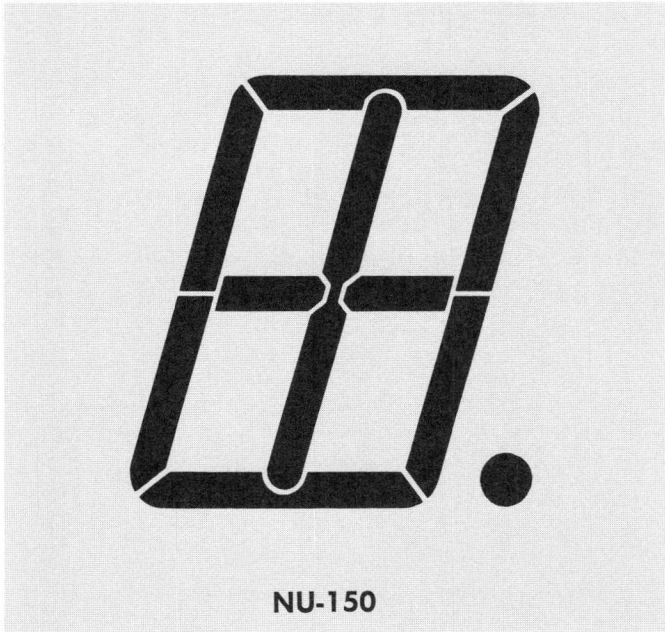

FIGURE 5

These two devices are constructed by patterning the top conductive layer to form the numeric (Figure 5) and the alpha-numeric (Figure 6) displays.

There is virtually no upper limit to the size of a display of this type. Characters, as small as three-eighths of an inch, are also feasible. These panels may be contacted readily by printed circuit connectors eliminating complicated connections. For those applications where printed circuit connectors cannot be used, the devices may be furnished with wire leads attached to each segment.

With the addition of a filter layer, the contrast of the displays can be increased to the point where it is clearly visible under ambient light conditions. These displays may be viewed through a wide angle and require very little space behind the panel. In addition, power requirements are extremely low.

Many sizes are available in both numeric (Fig. 5) and the alpha-numeric (Fig. 6) designs. These may be as small as $\frac{3}{8}$ " for numeric or $\frac{5}{8}$ " for alpha-numeric up to 10" for both numerics and alpha-numeric.

For applications requiring symbol type display, any design is obtainable provided only that the display can be segmented.

For use as display devices under normal ambient room

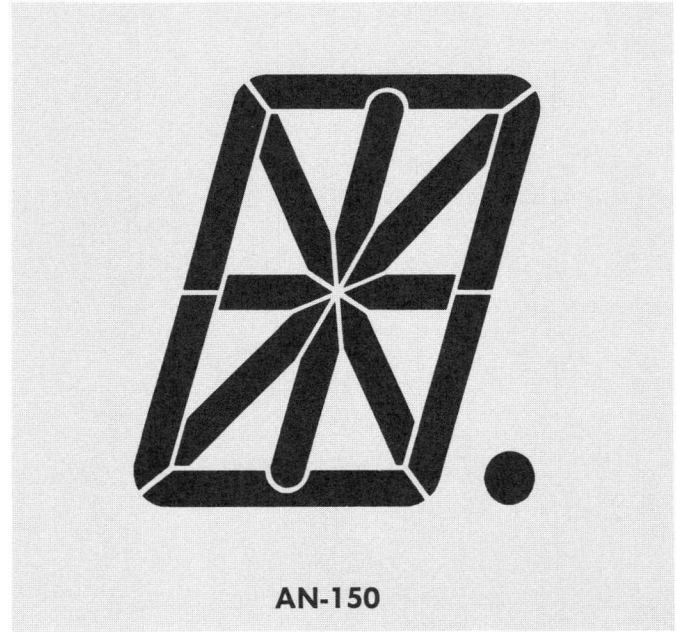

FIGURE 6

lighting, typical operating conditions are 200-220 volts rms and 400 cps. These conditions result in a light output of 7-8 foot lamberts with good maintenance. The power requirements are quite low. A $1\frac{1}{2}$ " numeric requires only 30mw when displaying the number 8 which results in maximum power.

The best EL phosphors available today are blue and green, and since the blue is somewhat more efficient than the green, it is generally used. All numerics and alpha-numeric are provided with a blue filter which improves contrast and also minimizes reflections. Decay time is approximately 5-10us.

In addition to the obvious uses of displaying numbers and letters visually, considerable success has been achieved in photographic applications where permanent records are required. Contact exposure of the film eliminates optical projection systems and reduces cost. Since the film is primarily sensitive to the blue spectrum, the driving power is low.

As will be seen in the following material, the combination of electroluminescent lighting and photoconductive techniques make for a useful method of switching display devices. Since the eye must respond to the display, the typical photoconductor switching times of 100-200ms are adequate. Other designs utilizing neon-photoconductive techniques result in faster switching times.

PHOTOCONDUCTOR — ELECTROLUMINESCENCE SWITCHING

The capability of adding a photoconductive control element to the electroluminescent lamp produces a tool which can be used as a solid-state switching device. This basic photoconductive-electroluminescent switch makes it possible to build circuits to process complex logical functions. These circuits are capable of converting information to another form without the need of bulky

and complicated mechanical switches or diode networks.

A schematic for a photoconductive-electroluminescent switch is shown in Figure 7. With the AC supply on, the voltage drop across the electroluminescent element is insufficient to activate the lamp. When the electroluminescent trigger lamp is activated, its light lowers the resistance of its associated photoconductor and current will then flow through the load, which, in this case, is another electroluminescent lamp.

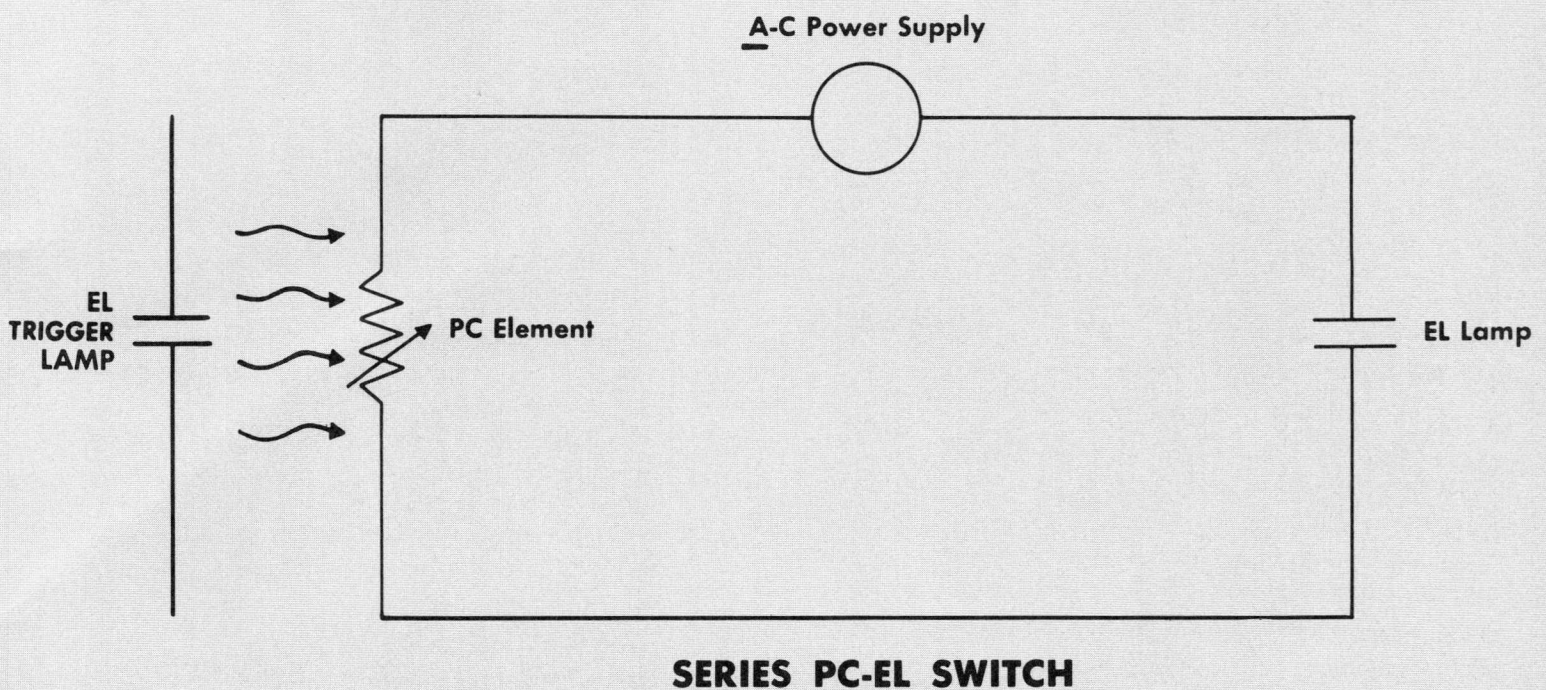

FIGURE 7

Logic Systems

“AND” LOGIC Further extension of the basic photoconductive-electroluminescent switching principle lends itself to logic circuits. Figure 8 is a schematic representation of an “AND” logic circuit. In this illustration, three photoconductive elements are connected in series with an electroluminescent lamp and an AC power supply. Opposite each photoconductive element is an electroluminescent lamp “masked” from all but the photoconductive element directly in front of it. The electroluminescent lamps are connected to a power supply through a switch. If

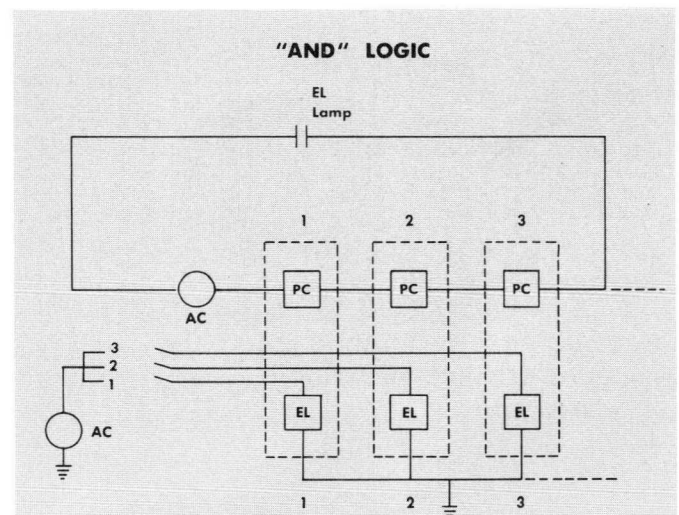

FIGURE 8

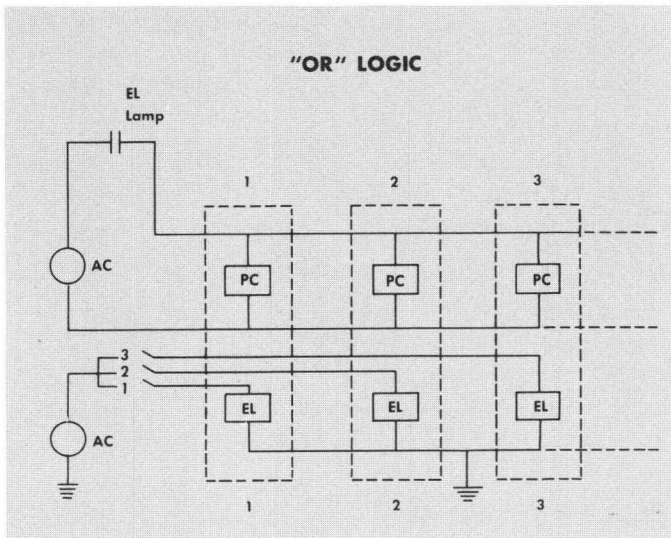

FIGURE 9

switch #1 is closed electroluminescent lamp #1 will light and photoconductive element #1 will become conductive; however, the lamp will not light. The same phenomenon will take place if switch #2 is closed with or without switch #1 closed. If all three switches are closed simultaneously, there is a conductive path and the lamp will light. Hence, if we have switches 1 and 2 and 3 closed, the lamp will light and we have the "AND" logic function.

"OR" LOGIC Figure 9 is identical to Figure 8 except that the photoconductive elements are connected in parallel with the voltage supply and electroluminescent lamp. If switch #1 is closed, electroluminescent lamp #1 will light. Photoconductive element #1 will become conductive and the electroluminescent output lamp will light. Therefore, if switch #1 or #2 or #3 is closed, the lamp will light and we have the "OR" logic function.

The foregoing "AND" and "OR" logic circuits are panel devices. It should be noted that only optical coupling is used for switching. The only electrical connections are inputs and outputs which are made at the edges of the panel. As a consequence, various combinations are possible on a single panel resulting in versatile circuits having a high packing density.

CIRCUIT ELEMENTS Many novel designs are possible using various combinations of electroluminescent-photoconductive switching. Figure 10 shows a circuit element which has been designed for breadboarding "AND", "OR", "inverter" and memory circuit logic. This device consists of an electroluminescent lamp and three photoconductor cells which represents a 3PST switch.

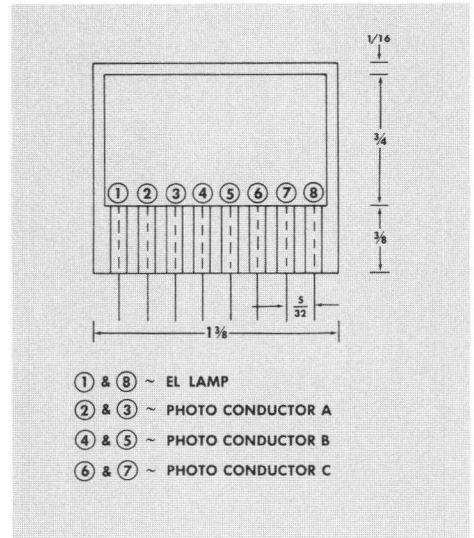

FIGURE 10

When operated under suggested conditions of 200 volts rms and a frequency of 400 cps, the dark and light impedances of the photoconductive cells have the following characteristics:

1. Three lighted photoconductor cells in series will be low enough in impedance to allow one electroluminescent lamp in series to light.
2. The dark impedance of up to three photoconductive cells in parallel will extinguish one electroluminescent lamp in series.
3. The light impedance of any one photoconductor will light two associated lamps sufficiently bright to lower the impedance of their associated photoconductors to light an additional lamp.

Once the initial circuit is known, it is possible to manufacture complete circuit combinations on a single base sheet. This results in high packing density and ease of maintenance.

INFORMATION CONVERSION Numeric Display With Photoconductive-Electroluminescent Translator

In many applications it is desirable to translate decimal information into a visual display. Examining element D in Figure 11 it is noted that each number or digit is composed of the following segments on the numeric panel:

Segment	Segment
1 — l	6 — a, b, j, n, p
2 — a, f, g, h, j, p	7 — a, f, n
3 — a, f, h, n, p	8 — a, b, f, g, h, j, n, p
4 — b, f, g, h, n	9 — a, b, f, g, h, n, p
5 — a, b, g, h, n, p	10 — a, b, f, j, n, p

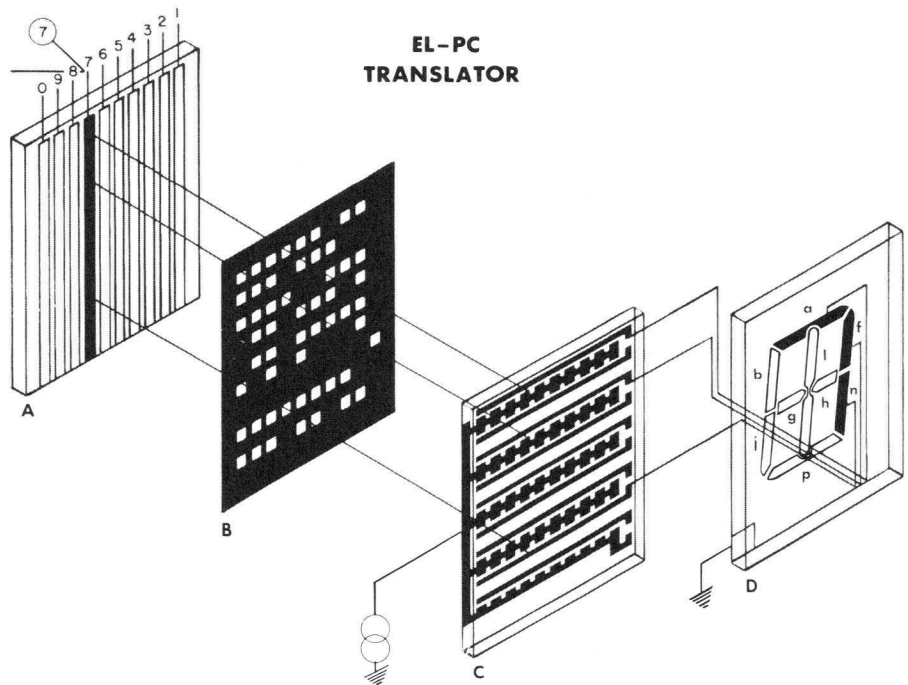

FIGURE 11

For instance, if it is desired to light the number "7" on the panel after an electrical signal has been applied to the terminal for the figure "7", segments a, f and n must light to the exclusion of all other segments.

The description of a photoconductive-electroluminescent switch (figure 7) showed that if electroluminescent segments a, f and n were each in series with a photoconductive material, a means of turning the segments on and off would result.

Element A of Figure 11 shows an electroluminescent lamp with the top conductive layer patterned into ten

strips (0-9) resulting in a ten element lamp. A nine strip photoconductive device is shown at element C of Figure 11. Each photoconductive strip is in series with its corresponding segment in the numeric panel. A mask or overlay is inserted between the electroluminescent and photoconductive layers. When electroluminescent strip number "7" is on, the light from it strikes only the a, f and n strips of photoconductive material... they become conductive and the a, f, and n segments of the lamp will light. This same procedure is used for displaying each of the other digits.

BINARY TO DECIMAL CONVERSION In many computer applications it is desirable to convert from the binary number system to the decimal system. Photoconductive-electroluminescent switching can also be used to obtain this end. In the binary system shown below, the digits 0-9 are represented in the following manner:

0 = 0000	5 = 0101
1 = 0001	6 = 0110
2 = 0010	7 = 0111
3 = 0011	8 = 1000
4 = 0100	9 = 1001

Figure 12 schematically represents the photoconductive-electroluminescent device which will convert binary input information into decimal output information. In essence, the device consists of eight panel-essent strips in four pairs with a strip in each pair representing "0" or "1". Across the array of electroluminescent strips are four series photoconductive "connections" at the appropriate "0" or "1" to give the desired digit. The photoconductive "connections" representing binary to decimal conversion are in turn

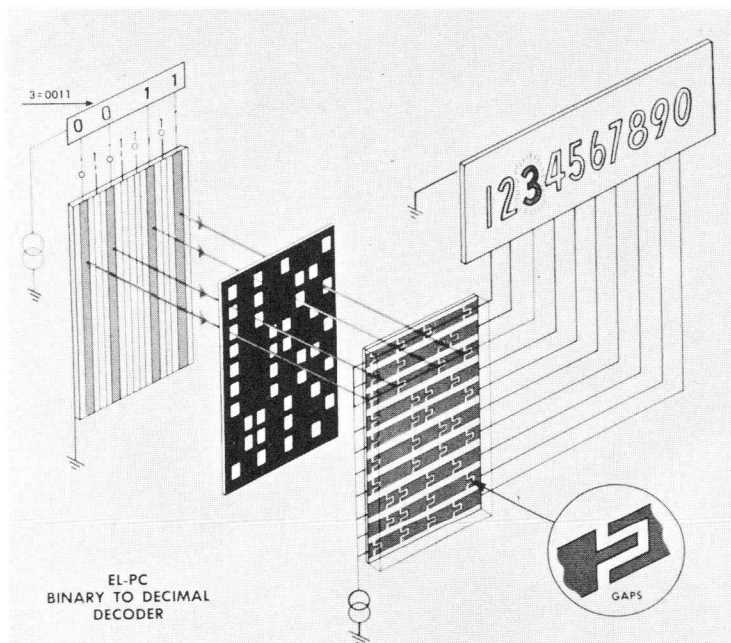

FIGURE 12

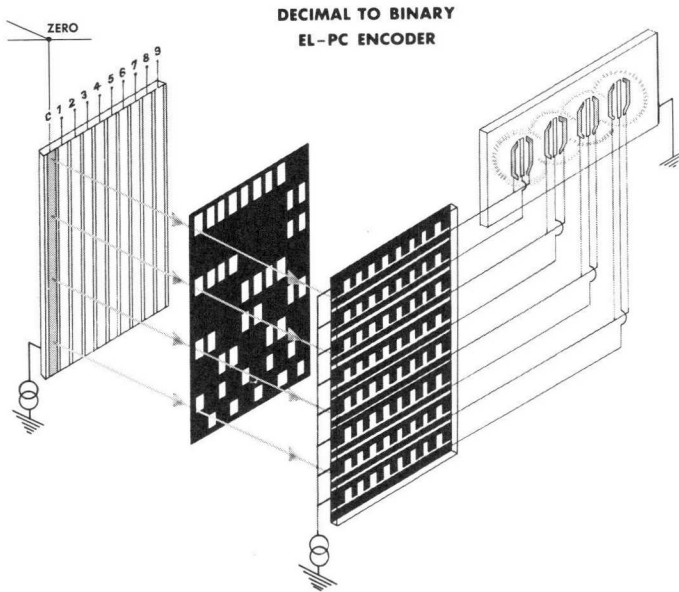

FIGURE 13

connected in series resulting in a four element "AND" logic circuit.

Suppose the binary number "0011" is the input to the device. In this case the electroluminescent strips 0, 0, 1, and 1 will light in the first, second, third and fourth pairs of electroluminescent lamps respectively. With the lamps lit, the only series of four photoconductive-electroluminescent switches that will allow current to flow is represented by the digit "3". This is the only case where all four sections of photoconductive material have been illuminated and with this illumination they have become conductive and current is permitted to flow.

Other inputs will result in conversion to decimal number outputs when the proper four sections of the photoconductive material in series are illuminated. It is interesting to note that in combination with the numeric display segment translator, binary input to visual decimal display output is possible.

DECIMAL TO BINARY CONVERSION

Decimal to binary conversion is equally desirable in computer applications. Figure 13 pictorially shows this operation. With a decimal input to the converter, the photoconductive strip corresponding to the appropriate binary digits will be activated. This selective lighting may be accomplished by a mask or overlay placed between the electroluminescent strips and the photoconductive strips. Therefore, a simple device capable of converting decimal to binary information is created. It will be noted that this device employs the "OR" logic circuit.

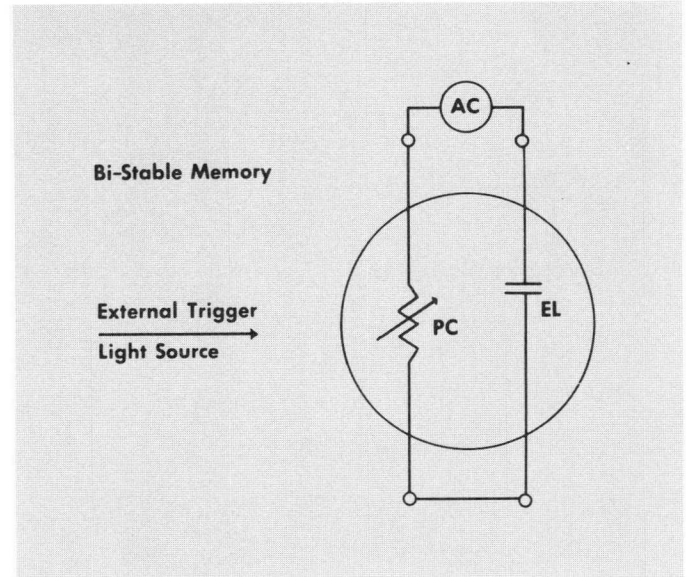

FIGURE 14

STORAGE OR MEMORY DEVICES A simple method of obtaining a storage or memory device is shown in Figure 14. In this device the photoconductive cell is optically coupled to the electroluminescent element. If the photoconductor has been initially triggered either optically or electrically, resistance decreases and the electroluminescent element is activated. Due to the optical coupling, the electroluminescent lamp will now keep the resistance of the photoconductor low. The original trigger may now be removed and the electroluminescent lamp will remain lighted until the circuit is opened.

The above, however, pertains to only one bit of information. The bi-stable panel device shown in Figure 15 is able to store a considerable number of bits of information.

An additional layer not previously mentioned is a masking grid which is used to prevent optical cross triggering of the bi-stable photoconductive-electroluminescent elements.

In operation a voltage is applied across the bottom transparent conductive layer on the glass and the wire mesh on the photoconductive layer. When no light is shining on the device, the photoconductor retards the flow of current from the wire mesh to the electroluminescent layer. When light is allowed to fall on the photoconductive layer a current flows to the electroluminescent element corresponding to the segment where the light falls.

With the feedback which results from the electroluminescent element to the photoconductive element,

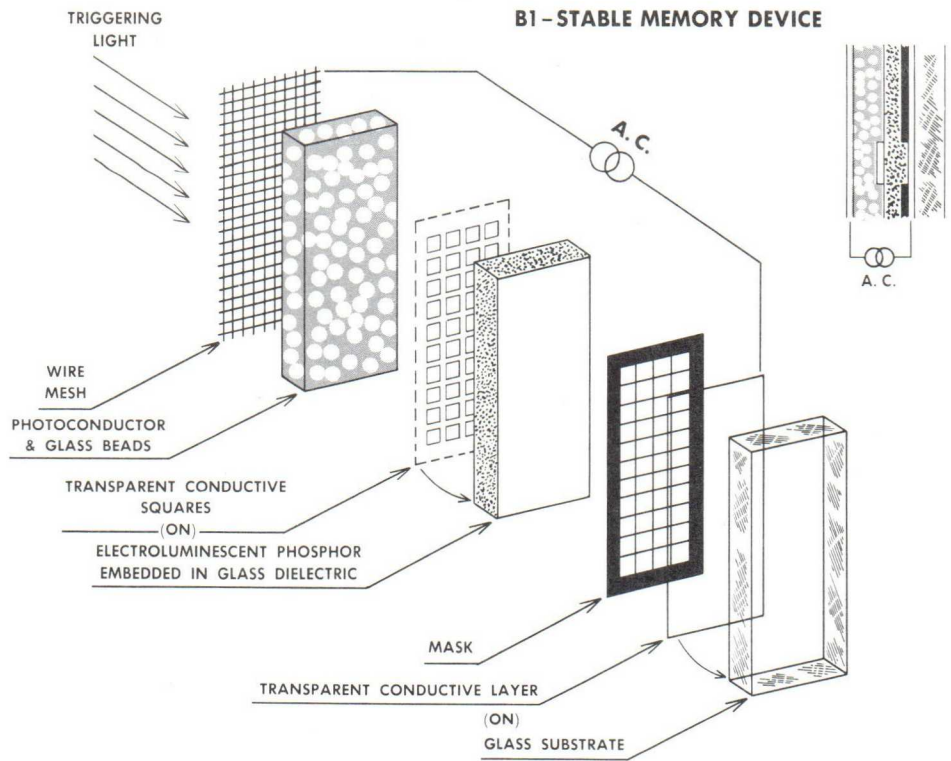

FIGURE 15

the bi-stable "on state" is obtained. The electroluminescent element will remain lighted until the voltage is removed.

We, therefore, have a device which is capable of converting momentary light pulses impinging on the device into an image composed of many dots of light. This image can be stored for any desired hold period.

The bi-stable panel may be triggered from a crossed grid behind the panel. Therefore, it is possible to feed information into the device sequentially and read out in parallel for use in permanent memory storage. Another application using this technique is a tracking display. Since the devices may be placed side by side, panels of almost any size may be fabricated.

IMAGE CONVERTER The image converter (Figure 16) is similar to the bi-stable panel just discussed. The basic difference is that the transparent conductive squares between the photoconductor and the electroluminescent phosphor are replaced by a layer of opaque ceramic. An applied A.C. voltage is divided across these layers and with no external stimulation the photoconductive layer drops practically all of the voltage due to its very high resistance. The photoconductor material is sensitive in the infra-red range. Thus when infra-red energy strikes the photoconductor its resistance is lowered and the voltage across the phosphor layer becomes higher at that point causing it to emit visible light. When the infra-red excitation is removed, the light goes out since there is no optical feedback.

Large area devices are possible using this technique. They are presently being fabricated in a 4" x 4" size. Power requirements are low.

ADDITIONAL APPLICATIONS Many of the applications of electroluminescent-photoconductive devices described in this booklet were not commercially available a year ago. Design Engineers involved in a wide range of electronic equipment have and are continuing to contribute to the growing list of uses for EL-PC. During the next year it is expected that many more applications will be developed through the combined efforts of equipment manufacturers and Sylvania Engineers.

If you would like to discuss electroluminescent-photoconductive applications for your specific area and equipments, contact any Sylvania Sales Office listed on the back cover of this booklet.

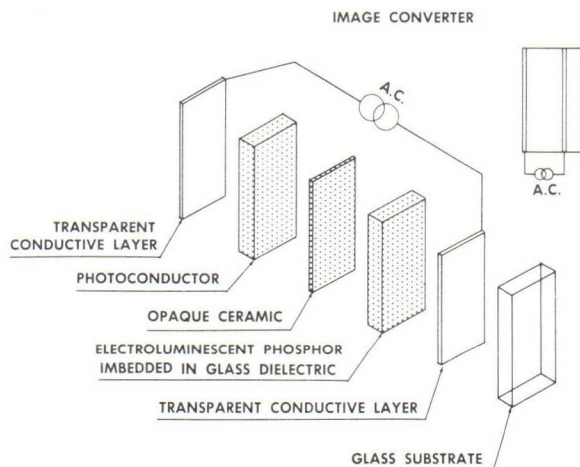

FIGURE 16

SYLVANIA

Subsidiary of **GENERAL TELEPHONE & ELECTRONICS** 

SYLVANIA ELECTRIC PRODUCTS INC.
1740 Broadway, New York 19, New York

"This information is furnished without assumption of any responsibility on the part of Sylvania for its use and without expressed or implied granting of any rights which Sylvania may have therein."

EQUIPMENT SALES OFFICES

CHICAGO

2001 North Cornell Ave.
Melrose Park, Illinois
Esterbrook 9-2525

DALLAS

100 Fordyce Street
Dallas 2, Texas
Riverside 1-4836

DAYTON

333 West First Street
Dayton 2, Ohio
Baldwin 3-6227

FLORIDA

Suite "C"
1520 Edgewater Drive
P.O. Box 7248 Orlando, Florida
Garden 4-8245

FORT WAYNE

4740 Coldwater Road
Fort Wayne, Indiana
T3-1145

LOS ANGELES

6505 East Gayhart Street
Los Angeles 54, California
RAymond 3-5371

MASSACHUSETTS

281 Main Street
Wilmington, Mass.
OL 8-3354

NEW YORK

1000 Huyler Street
Teterboro, New Jersey
ATlas 8-9484
From N.Y.C. CHickering 4-8820

NEW YORK—Upstate

Seneca Falls, New York
LOgan 8-5881

SAN FRANCISCO

1811 Adrian Road
Burlingame, California
OXford 7-3500

WASHINGTON D.C.

1120 Connecticut N.W.
Washington, D. C.
FEderal 7-6600

CANADA

6233 Cote De Liesse Road
Montreal 9, Quebec