

RCA

nvvistors

INDUSTRIAL
and
MILITARY

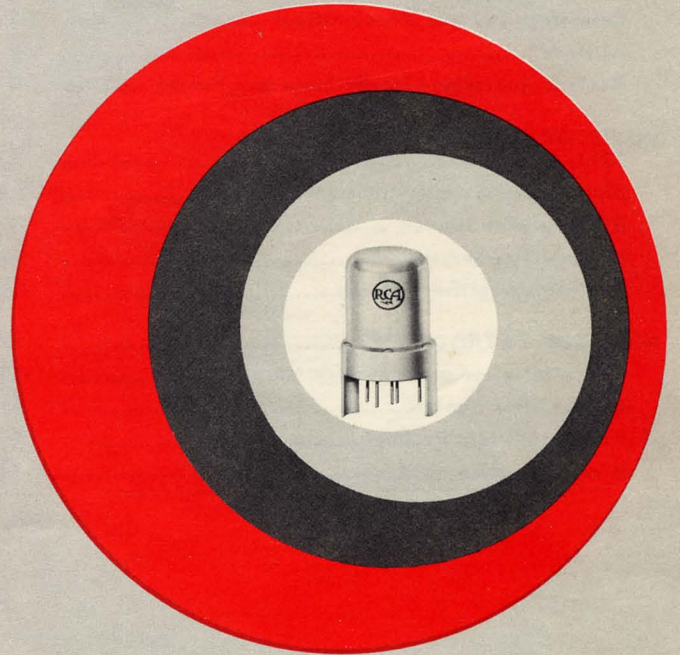

Radio Corporation of America
ELECTRONIC COMPONENTS AND DEVICES HARRISON, N.J.

TABLE OF CONTENTS

	PAGE		PAGE
BASIC NUVISTOR CONCEPT	3	NUVISTOR UHF-AMPLIFIER TRIODE 8058	12
Uniformity of Characteristics.....	3	Characteristics and Maximum Ratings	12
Reliability.....	4	Typical Operation	12
ENVIRONMENTAL PERFORMANCE	4	NUVISTORS FOR CLASS C SERVICE –	
Temperature Effects	4	8627, A15526	12 – 16
Shock	6	Characteristics and Maximum Ratings.....	16
Sweep-Frequency Vibration and		Typical Operation	16
Fatigue Vibration	6	WARM-UP TIME	17
Variable-Frequency Vibration	6	NOISE	17
Random Vibration	7	Low-Frequency Noise	17
Resonance-Cycling Vibration.....	7	RF Noise	17
Centrifuge (Linear Acceleration)	7	Description of Measuring Circuit	18
Altitude	7	INPUT CHARACTERISTICS	18
Nuclear Radiation (Steady-State and Pulse)	7	Grid Current	18
NUVISTOR TRIODES 7586, 7895, 8056,		Input Conductance and Susceptance	20
8393, 8628.....	8	Transit-Time Estimates.....	20
Characteristics and Maximum Ratings	8,9	CROSS MODULATION	21
RF-Amplifier Service	9	OPERATING PRECAUTIONS	21
IF-Amplifier Service	11	ADDITIONAL TECHNICAL INFORMATION	22
Audio-Preamplifier Service.....	11	NUVISTOR-TUBE SOCKET AND	
NUVISTOR TETRODE 7587	11	CONNECTOR INFORMATION	23
Characteristics and Maximum Ratings	11	DIMENSIONAL OUTLINES, TERMINAL DIAGRAMS,	
IF-Amplifier Design.....	11	AND MODIFIED BOTTOM VIEWS	24,25
Gain-Bandwidth Product	11	RCA FIELD SALES OFFICES	27
Mixer Operation	12		

RCA

INDUSTRIAL AND MILITARY NUVISTORS

BASIC NUVISTOR CONCEPT

Since RCA nuvistor tubes were first announced in 1959, they have been used in a wide variety of consumer, industrial, and military equipment. Millions of nuvistors are presently in use in such diverse applications as television-receiver rf amplifiers and in "hybrid" circuits in spacecraft such as Nimbus, Tiros, and Ranger. This booklet describes some of the significant design features and performance characteristics of the industrial and military nuvistor types.

Uniformity of Characteristics

The nuvistor design utilizes a light-weight, cantilever-supported, cylindrical electrode structure housed in an all-ceramic-and-metal envelope. Cutaway views

of the three basic nuvistor designs are shown in Figure 1. Dimensional outlines and terminal diagrams are shown on pages 24 and 25. Cylindrical symmetry provides a stable and efficient design, both electrically and thermally. This symmetry, together with the cantilever construction, permits the use of close-tolerance jigs for extremely precise tube assembly. The jig assembly of parts contributes to the consistent, dependable performance of nuvistor tubes.

The high values and tight limits for transconductance for industrial nuvistors are shown in Table I. The LAL and UAL values apply to the JAN specifications; the Min. and Max. values apply to both commercial and JAN specifications.

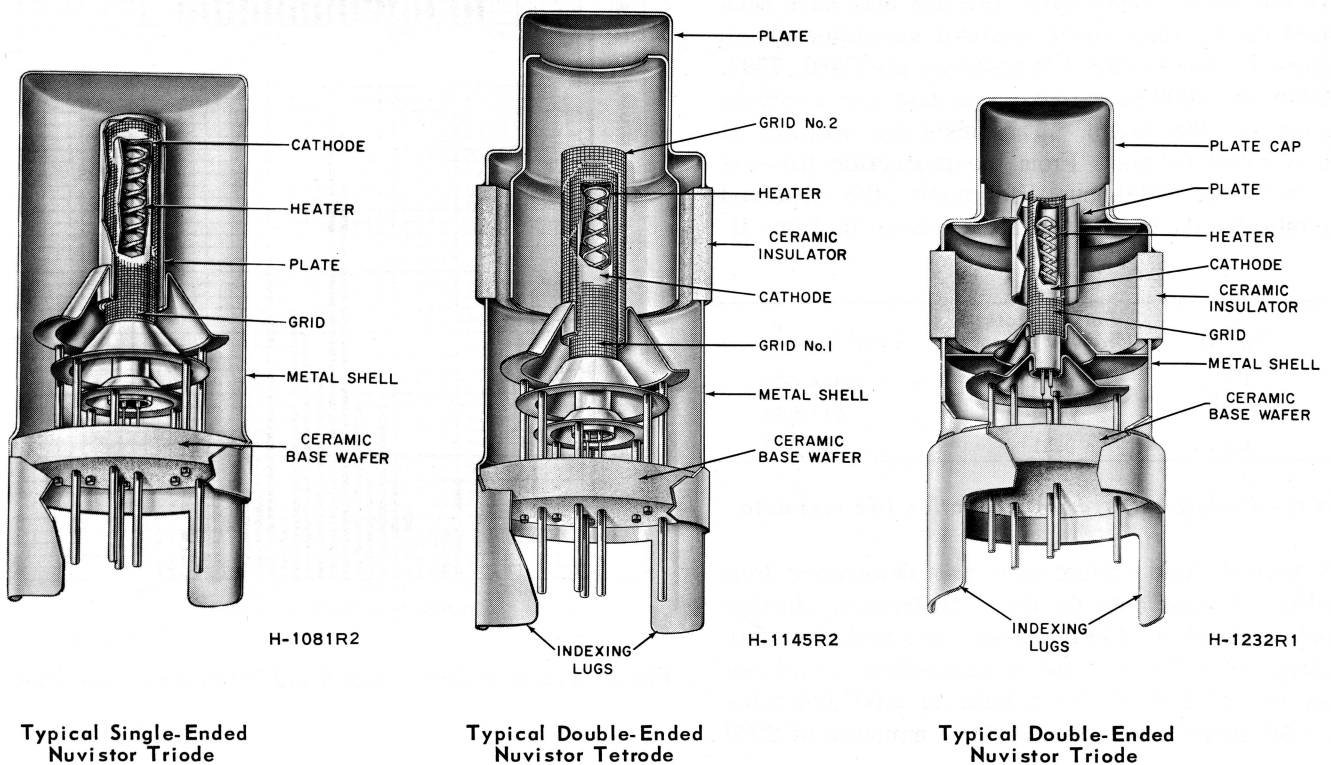

Fig. 1 - Cutaway views showing cylindrical electrodes and tripod-like supports.

Type	Min.	LAL	Bogey	UAL	Max.	JAN Spec. MIL-E-1/
7586	10000	*	11500	*	13000	1397C
7587	9000	10000	10600	11200	12200	1434C
7895	7900	8800	9400	10000	10900	1433C
8056	6500	7000	7500	8000	8500	1490B
8058	10000	11600	12400	13200	14800	1491B

* Plate current is controlled for LAL and UAL.

Table I - Initial limits for transconductance (in μmho) for industrial and military nuvistors.

Reliability

RCA nuvistors are especially suited for use in applications in which long-term reliability is a critical design consideration. The combination of strong structural assembly and high-temperature processing produces tubes capable of giving thousands of hours of trouble-free life. The excellent vacuum obtained in the nuvistors is a result of a 10-minute processing cycle during which the tube is fired in a vacuum at a temperature of 850°C to outgas all the parts of the nuvistors thoroughly. Final seal-off is made at a temperature of approximately 950°C .

The nuvistors utilize RCA Dark Heaters which operate efficiently at low temperatures, thus minimizing heater problems initially and throughout life.

To determine failure rates, life test data have been compiled on the three basic nuvistors structures shown in Figure 1. Production life tests on the 7586, 7587, and 8058 are 1000-hour tests; one test per month is continued to 5000 hours. The tubes are operated at maximum rated values. From the production life-test data, including 5000-hour life tests, the observed failure rates for the three types are as shown in Table II.

Type	P_b (W)	Failure Rate (%/1000 hours)	Total Tube-Hours
7586	1	0.71	2,384,000
7587	2.2	0.81	617,000
8058	1.5	0.31	330,000

Table II - Failure rates, from production life test data.

A typical field failure rate was determined from reliability life test data for the 7586 triodes. In this life test, a sample of 146 tubes was operated at a plate dissipation of 0.75 watt and a metal-shell (envelope) temperature of 150°C for a total of 2,001,000 tube-hours. All tubes were operated for a minimum of 2000

Type	P_b (W)	Failure Rate (%/1000 hours)	Total Tube-Hours
7586	0.75	0.099	2,001,000

Table III - Failure rate, from reliability life test data, type 7586.

hours; a fifty-tube sample was continued to 30,000 hours. The observed failure rate for this life test was 0.099% per 1000 hours, as shown in Table III. Comparable failure rates should be expected for the other nuvistors types when they are operated at typical conditions, approximately three-fourths of maximum rated values.

Figure 2 shows transconductance data for the 7586 nuvistors from the reliability life test described above. Comparison of the initial and 2000-hour data shows the uniformity of transconductance of the 7586 over an extended period of operation.

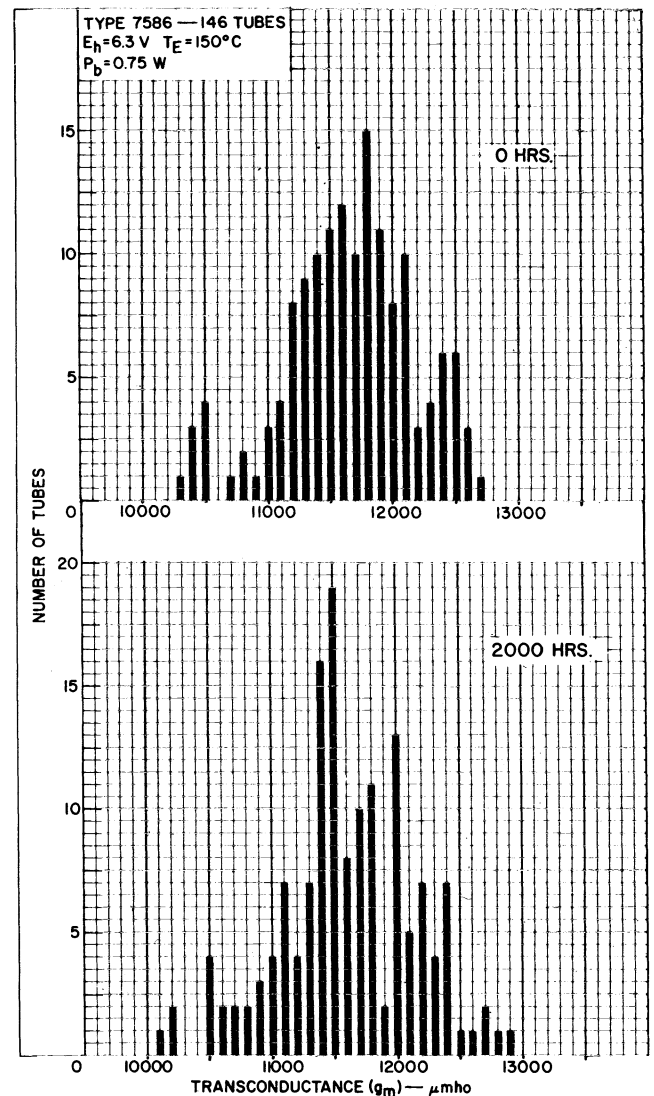

Fig. 2 - Transconductance at 0 and 2000 hours, type 7586.

ENVIRONMENTAL PERFORMANCE

Temperature Effects

The unique construction of the nuvistors provides efficient conduction paths for heat transfer from tube elements to socket and chassis. Nuvistors thus offer

the advantage of heat transfer by conduction, as a result of the following features:

- (1) improved packaging density,
- (2) minimum spacing requirements between nuuivitors and other components (surrounding air has little effect on nuuivistor shell temperature when the socket provides adequate contact between the shell and the chassis),
- (3) elimination of additional components for radiation or convection cooling.

Maximum grid-circuit-resistance ratings of RCA industrial nuuivistor tubes apply for metal-shell temperatures of 150° C. The metal-shell (or envelope) temperature of a nuuivistor is determined by a thermocouple-type measurement made in the area shown as Zone "A" in the dimensional outline drawings, pages 24 and 25. On the small-signal, general-purpose nuuivistor types, temperatures as high as 250° C are permitted if

the grid-circuit-resistance value is decreased, as shown in the grid-circuit-resistance rating charts, Figure 3.

Maximum ratings for chassis temperature are of primary interest to circuit and package designers. Figure 4 shows combinations of plate dissipation and chassis temperature which produce metal-shell temperatures of 150° C in Zone "A" for industrial nuuivistor tubes operating in conventional sockets under high-line-voltage conditions (heater voltage of 6.9 volts). For example, the curve for type 7586 shows that this tube may be operated at full plate dissipation and maximum grid-circuit resistance at chassis temperatures up to 85° C without exceeding the maximum metal-shell temperature rating. At chassis temperatures above 85° C, the plate dissipation must be reduced to the indicated percentages to avoid excessive shell temperatures. The maximum permissible chassis temperature for zero plate dissipation is less than the shell temperature rating because the heater power increases the shell temperature.

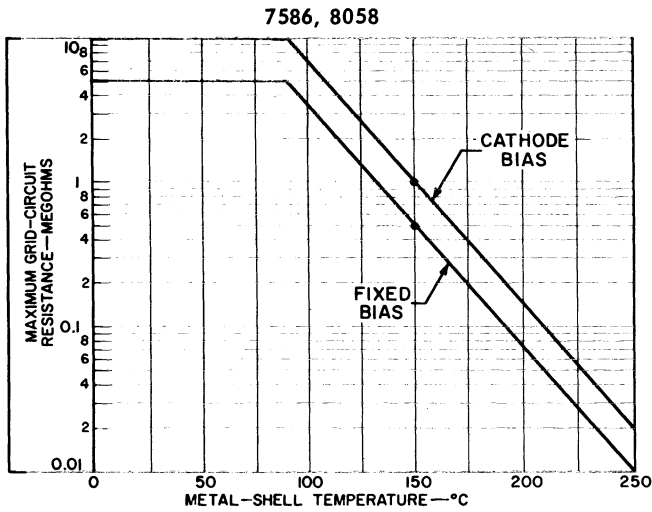

92CS-12022

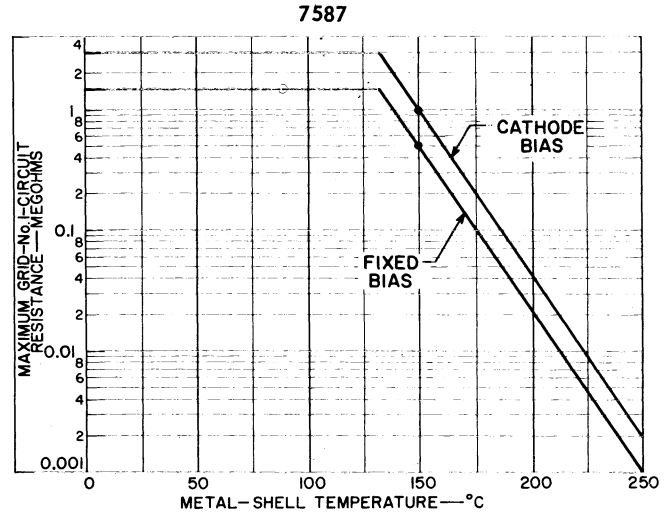

92CS-11896

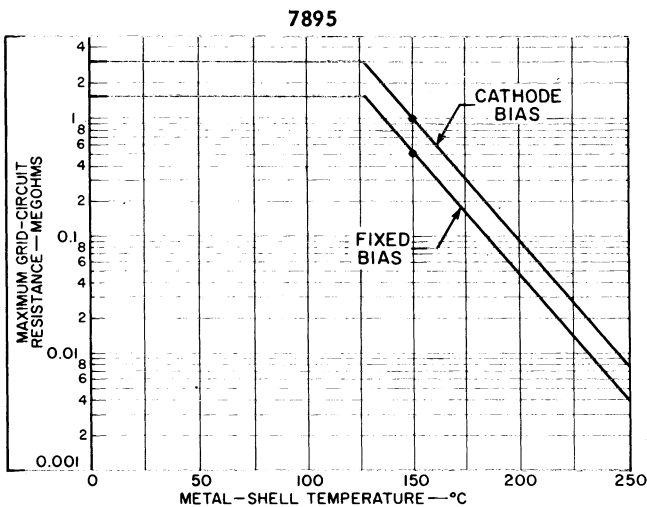

92CS-12023

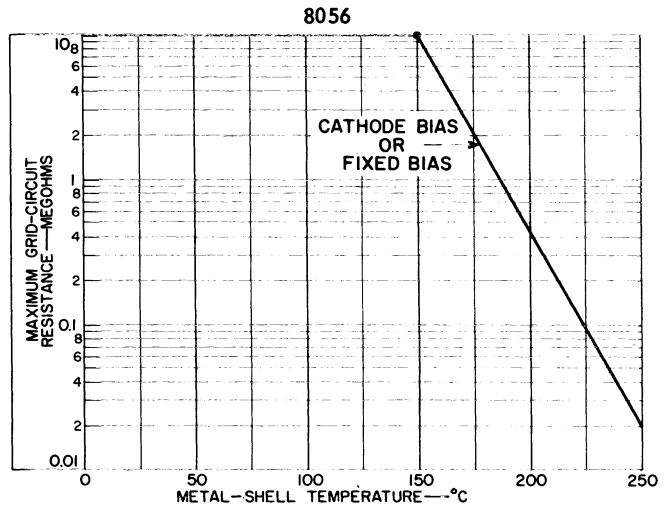

92CS-11479R1

Fig.3 - Grid-circuit-resistance rating charts.

It should be noted that the curves in Figure 4 apply only to chassis made of materials, such as steel or aluminum, that have good thermal conductivity. When nuvistors are mounted in low-conductivity materials, such as phenolic or fiber "printed-board" chassis, heat conduction is generally poorer, and it may be necessary to add additional heat-conduction paths to assure that the nuvistor temperature rating is not exceeded.

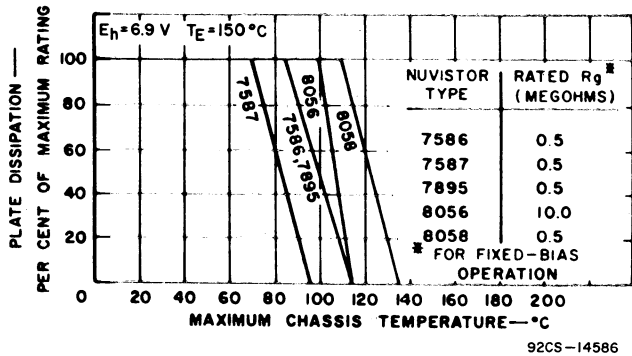

Fig. 4 - Combinations of plate dissipation and chassis temperature for metal-shell temperature of 150° C.

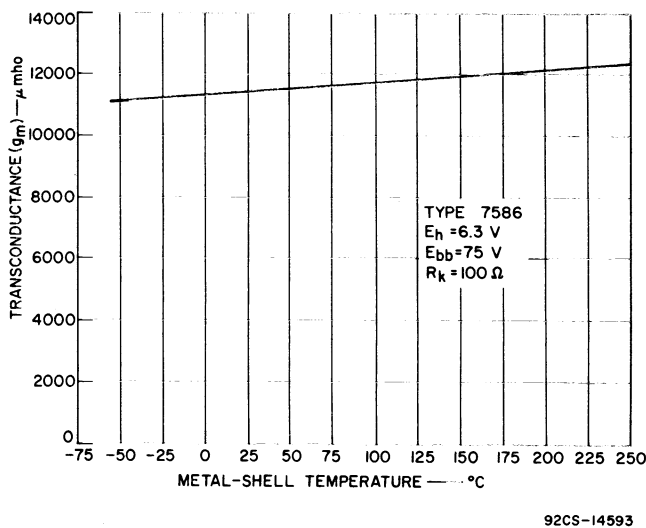

Fig. 5 - The effect of shell temperature on transconductance, type 7586.

The effect of shell temperature on electrical characteristics is shown in Figure 5. Although the curve shown is for the 7586, it is reasonable to assume that the general slope of the curve is the same for other nuvistors. The shift in transconductance is approximately 4 micromhos per °C. A general value for $|E_c/T_E|$, with E_b and I_b constant, is 0.2 millivolt per °C.

Shock

Nuvistors intended for military applications are required to withstand the following shock tests:

- (1) 1000-g-level, 0.8-millisecond shock test in accordance with Method 1041A of MIL-E-1E; all voltages applied,
- (2) 50-g-level, 11-millisecond, long-duration, shock test; no voltages applied.

The 1000-g, 0.8-millisecond shock test of the nuvistors is performed on samples from each production lot in accordance with paragraph 4.3.3 of MIL-E-1E; the 50-g, 11-millisecond shock test is performed as a Qualification Approval test. (All of the military nuvistor types are on Reduced Sampling for shock, with the Process Averages ranging from 1.5% to 4%.) Post-shock tests include shorts and continuity, change in transconductance, reverse control-grid current, heater-cathode leakage current, and sweep-frequency vibration. The nuvistors must be within the endpoint limits specified for these tests.

Sweep-Frequency Vibration and Fatigue Vibration

The nuvistor military types are tested for both sweep-frequency vibration and fatigue vibration.

The sweep-frequency vibration test is performed at the 1-g acceleration level, from 50 Hz to 15 kHz. The outputs obtained as the elements of the tube are vibrated at their resonant frequencies must be within specified limits.

On types 7586, 7587, and 7895, the fatigue-vibration test is performed at a 2.5-g level, at 60 Hz, transversely, for a total of 48 hours in two directions. On types 8056 and 8058, the fatigue-vibration test is performed at a constant displacement of 0.08 inch, double amplitude, from 5 to 50 Hz and constant acceleration of 10 g from 50 to 500 Hz for a total of 9 hours in three mutually perpendicular directions. Post-vibration tests include shorts and continuity, change in transconductance, reverse control-grid current, heater-cathode leakage current, and sweep-frequency vibration. The nuvistors must be within the endpoint limits specified for these tests.

Variable-Frequency Vibration

Nuvistor types 7586, 7587, and 8058 were evaluated for variable-frequency vibration at displacement and acceleration levels more than twice those required in military specification MIL-T-5422 (ASG), Part 1, Curve 1. The conditions for this engineering test are as follows:

- (1) Full operating voltages are applied to tubes,
- (2) The displacement is held constant at 0.25 inch as the vibration frequency is varied from 5 to 40 Hz,

- (3) A constant acceleration of 20 g is maintained as the vibration frequency is varied from 40 to 500 Hz,
- (4) Total time required to sweep full range of vibration frequencies, 5 to 500 Hz, is 15 minutes, in each of three mutually perpendicular directions,
- (5) Duration of test along each axis is 3 hours,
- (6) Total test time is 9 hours per tube.

At the end of this special test, the nuvistors were within the post-vibration endpoint limits for the characteristics and tests listed above.

Random Vibration

Nuvistors have been evaluated to determine their ability to withstand random vibration in accordance with a specification prepared by NASA for a satellite subsystem. The requirements were 20 g rms from 20 to 2000 Hz in three mutually perpendicular axes; test time was 4 minutes per axis. The tubes were not required to be electrically operated during vibration. Electrical tests of ten tubes subjected to the random-vibration test showed that the operation of all the tubes was within the post-vibration endpoints.

Resonance-Cycling Vibration

Because the mechanical resonances of the nuvistors grid and plate are extremely high (approximately 12 and 14 kHz, respectively), a cycling test over the cathode resonance range is performed. The test consists of cycling between 6 kHz and 10 kHz at 20 g for one hour in the transverse axis. A twenty-tube sample of 7586 nuvistors was tested to these conditions, and easily met the post-vibration endpoints for the tests. Similar resonance dwell tests have been conducted on the other nuvistors industrial and military types without deterioration of tube characteristics.

Centrifuge (Linear Acceleration)

A test-to-destruction conducted on thirty developmental prototype 7586 nuvistors indicates that these nuvistors can withstand centrifuge levels of 3000 g for 1 minute in each of the three major axes. In steps of 500 g, ten nuvistors were tested up to 10,000 g without failure in the X direction (long axis of the tube perpendicular to the radius of rotation); ten tubes were tested up to 16,000 g without failure in the Z direction (tube major axis co-linear with radius of rotation, and base facing center of rotation); and ten tubes were tested up to 3500 g without failure in the Z direction (tube major axis co-linear with radius of rotation, but with tube top facing the center of rotation).

A second test of ten 7586 tubes to 3000 g for 1 minute in each axis met the post-vibration endpoints for the tests listed above.

Altitude

The basic nuvistors can perform satisfactorily at any altitude if tubes are operated within maximum ratings. Figure 6 shows the breakdown-voltage characteristics of the class C nuvistors, types 8627 and A15526.

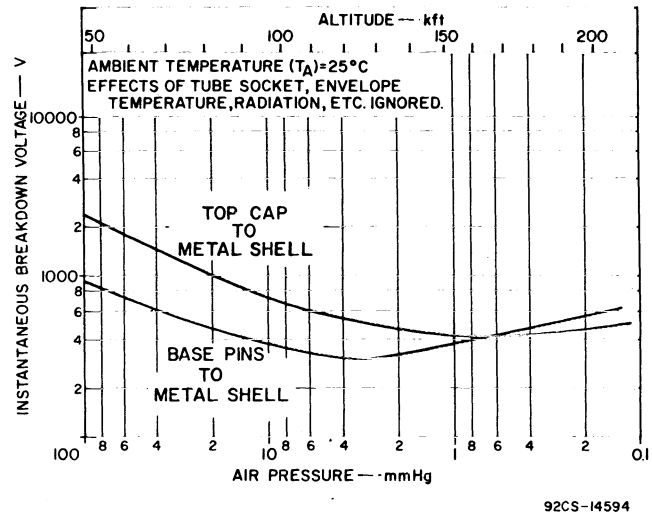

Fig. 6 - Breakdown-voltage characteristics, type 8627 and dev. type A15526.

Nuclear Radiation

Steady State

Nuvistors have been subjected to a steady-state nuclear-radiation environment consisting of both neutron and gamma fields. The nuvistors were exposed for 3 hours in a radiation field of a fast-neutron-flux of 10^{13} neutrons per square centimeter per second ($E > 1$ MeV) and a gamma intensity of 10^8 roentgens per second. The nuvistors were exposed to this environment under both operating and nonoperating conditions, with no permanent damage occurring in either case. In addition, the operating nuvistors continued to function during the 3-hour period.

Pulse

Nuvistors tubes have been operated as audio-frequency amplifiers and monitored before, during, and after exposure to pulsed nuclear irradiation having a peak-fast-neutron-flux of 10^{15} neutrons per square centimeter per second and a peak gamma intensity of 10^7 roentgens per second.¹ The transient response of these tubes followed the nuclear-irradiation pulse and returned to normal, with no permanent damage to the tubes. The transient response of nuvistors is 1/10 to 1/5 of the response of conventional miniature glass tubes.

¹ I.F. Stacy and F.J. Feyder, "Pulsed Nuclear Irradiation of Nuvistors," *RCA Review*, Nov. 1966, Vol. XXVII, No. 3, p. 408-424 (RCA reprint ST-3079).

NUVISTOR TRIODES 7586, 7895, 8056, 8393 AND 8628

These five industrial nuvistor triodes are useful in a wide range of applications, including rf- and if-amplifier service, audio-preamplifier service, and switching or on-off applications. The low heater-power requirements of the nuvistors make these types attractive for hybrid circuit applications. Figures 7 through 10 show the typical plate characteristics curves for the 7586, 7895, 8056, and 8628.

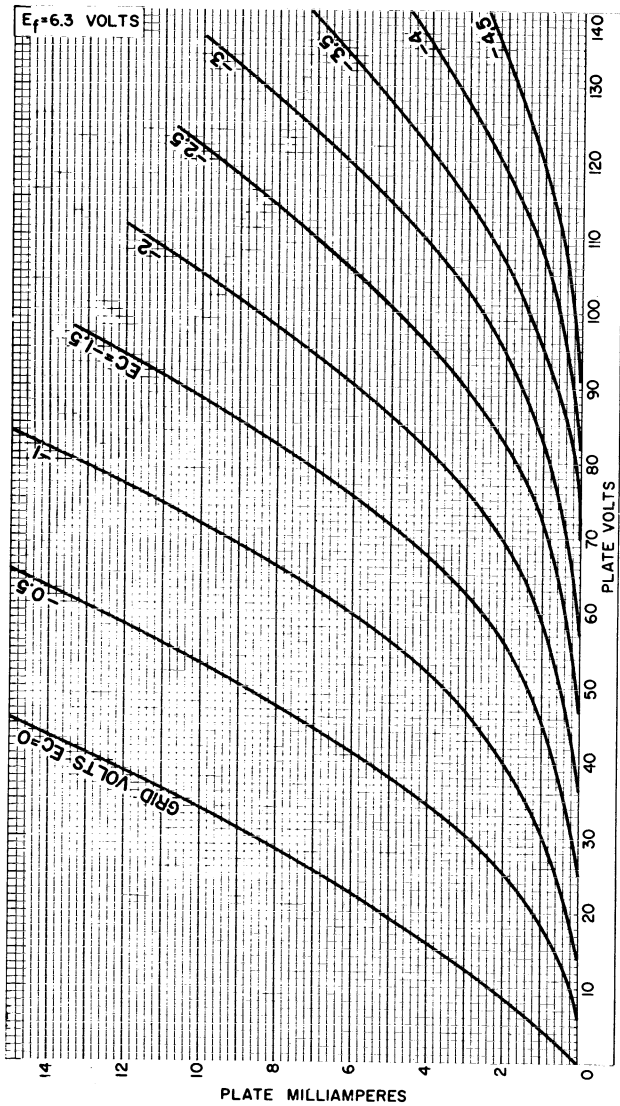

Fig. 7 - Typical plate characteristics, type 7586.

The 7586 is a general-purpose, medium-mu triode for use in high-gain, low-noise amplifier applications at frequencies up to 400 MHz, and as an oscillator tube having excellent stability over a wide range of frequencies.

The 7895 is a general-purpose, high-mu triode for use in high-gain, low-noise amplifier applications at frequencies up to 400 MHz and as an oscillator tube over a wide range of frequencies.

The 8056 is a medium-mu triode designed for operation with plate-supply voltages of 12 to 50 volts. This tube is especially useful in low-noise rf-amplifier, if-amplifier, control, multivibrator, and cathode-follower circuits, and other applications that require a device having high input impedance and excellent temperature stability.

When used with a low-voltage power supply, the 8056 can provide high gain with low noise in small-

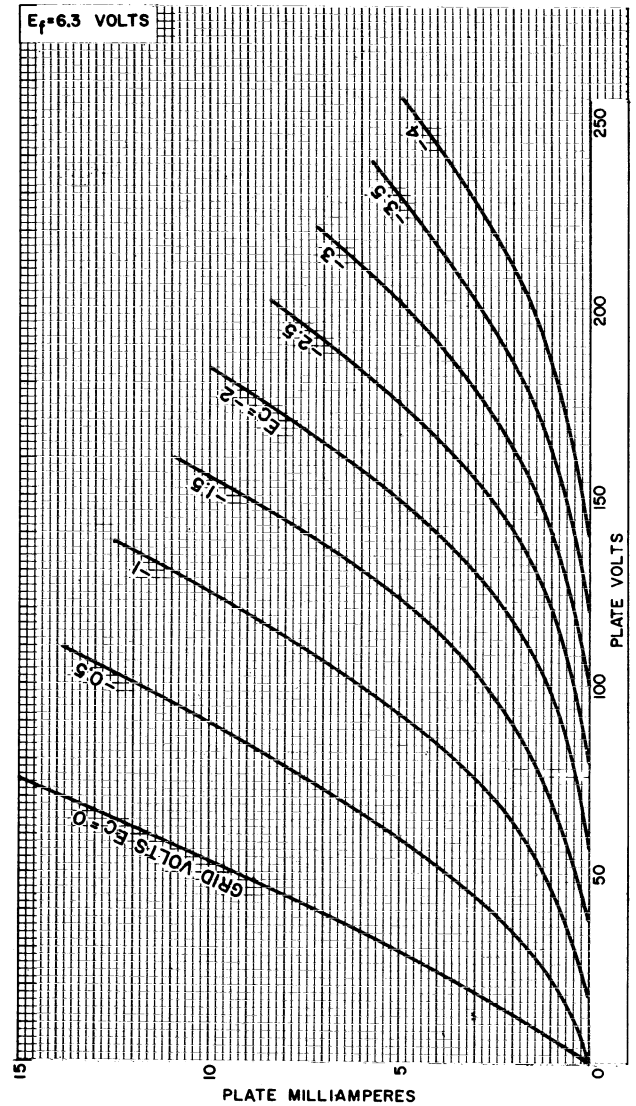

Fig. 8 - Typical plate characteristics, type 7895.

signal amplifier applications at frequencies up to 350 MHz.

The 8628 is a high-mu triode for extremely small-signal voltage-amplifier applications. This nuvistor is particularly suitable for applications that require low noise, high input impedance, and low grid currents at frequencies up to 200 kHz.

The 8393 is like the 7586 except for its heater rating of 13.5 volts/0.060 ampere.

TYPE	CLASSIFICATION	RCA Dark Heater		CHARACTERISTICS, Class A ₁ Amplifier										MAXIMUM RATINGS Absolute-Maximum Values For Operation at Any Altitude								MAXIMUM CIRCUIT VALUES	
		E _h V	I _h A	E _{bb} V	E _b V	R _k Ω	μ	r _p kΩ	g _m μmho	I _b mA	E _c (co) for I _b = 10 μA ^a V	E _{bb} V	E _b V	-E _c V	e _c V	I _c mA	I _k mA	P _b W	e _{hkm} V	Fixed Bias MΩ	Cathode Bias MΩ		
7586	Medium-Mu Triode	6.3	0.135	-	26.5	-b	31	4.4	7000	2.8	-	330	110	55	4	2	15	1	±100	0.5 ^c	1 ^c		
				-75	40	-b	35	3	11500	7.5	-											10.5	-7
7895	High-Mu Triode	6.3	0.135	110	-	150	64	6.8	9400	7	-4	330	110	55	2	2	15	1	±100	0.5 ^c	1 ^c		
8056	Medium-Mu Triode	6.3	0.135	24	-	100	11.5	1.53	7500	8.7	-5 @ 50 μA	-	50	55	2	2	15	0.45	±100	10 ^d	10 ^d		
8393	Medium-Mu Triode	13.5	0.060	For Characteristics and Maximum Ratings, refer to Type 7586.																			
8628	High-Mu Triode	6.3	0.100	120	-	200	127	41	3100	1.5	-1.7	330	250	55	+0	0	2	0.3	±100	50 ^e	100 ^e		

Table IV - Electrical data for nuvistor triodes 7586, 7895, 8056, 8393, and 8628.

^a Unless otherwise specified.

^b R_g = 0.5 MΩ.

^c For operation at metal-shell temperature of 150° C. For operation at other metal-shell temperatures, see Grid-Circuit-Resistance Rating Chart.

^d For operation at metal-shell temperatures up to 150° C. For operation at other metal-shell temperatures, see Grid-Circuit-Resistance Rating Chart.

^e Metal-shell (or envelope) temperature is limited to 150° C by an Absolute-Maximum Rating.

The electrical characteristics and maximum ratings of the 7586, 7895, 8056, 8393, and 8628 are shown in Table IV. The weight of each of these single-ended nuvistors is approximately 1.9 grams.

RF-Amplifier Service

The small size and short leads of the nuvistors make them particularly suitable for rf-amplifier applications at vhf. The high transconductance-to-plate-current ratio contributes to low tube noise factor. In addition, short-circuit input-impedance measurements indicate that the nuvistors have higher input resistance than other tubes having equivalent input capacitance and transconductance. These input-impedance measurements approximate the input resistance measurements of a completely neutralized triode in grid-drive operation. Increased input resistance results in increased gain, as shown by the following equation for power gain at vhf frequencies (impedance-matching losses are neglected):

$$\text{Power Gain} = \frac{\mu^2 R_S R_L}{(r_p + R_L)^2}$$

where μ is the amplification factor of the tube, R_S is the source resistance (matched to input resistance of the tube), R_L is the load resistance, and r_p is the plate resistance of the tube.

Gain characteristics of type 7895 operated at 200 MHz in a neutralized grid-drive amplifier in which

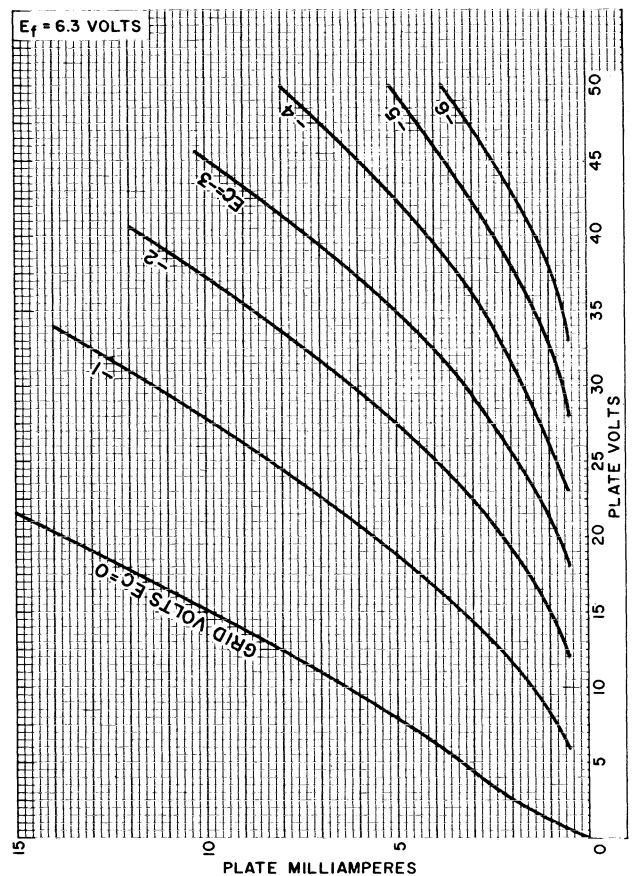

92CM-11469RI

Fig. 9 - Typical plate characteristics, type 8056.

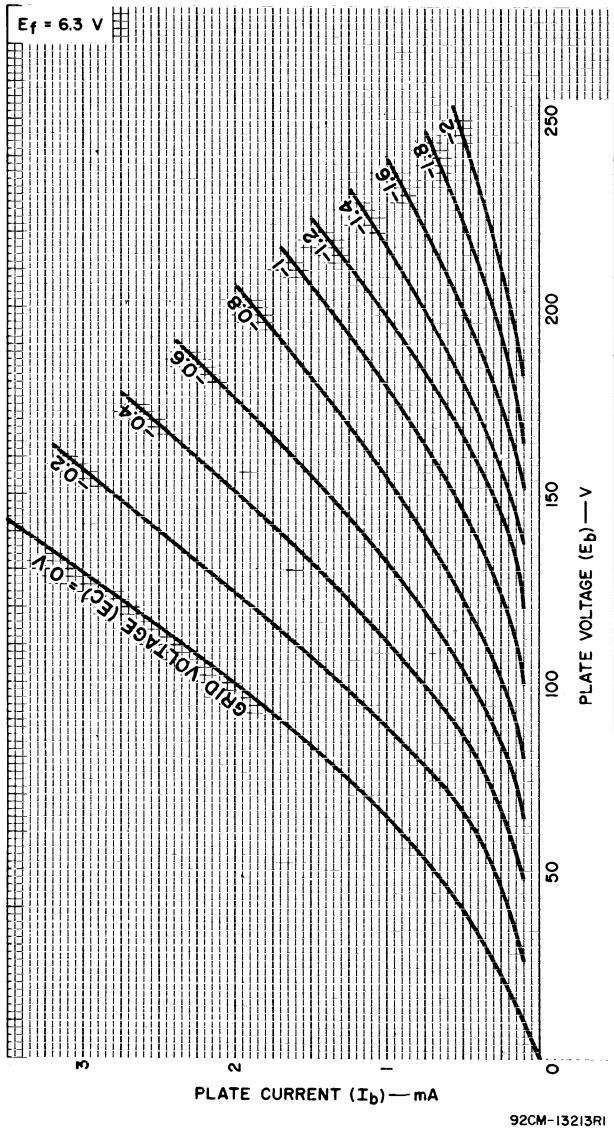

Fig.10 - Typical plate characteristics, type 8628.

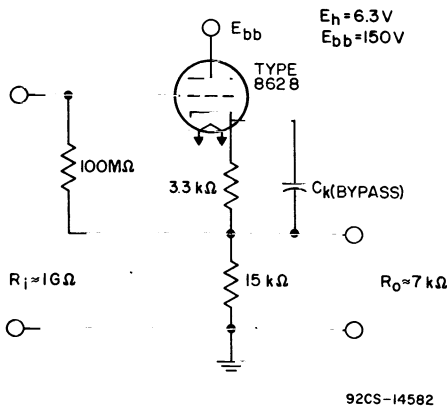

Fig.12 - High-input-impedance cathode-follower circuit, type 8628.

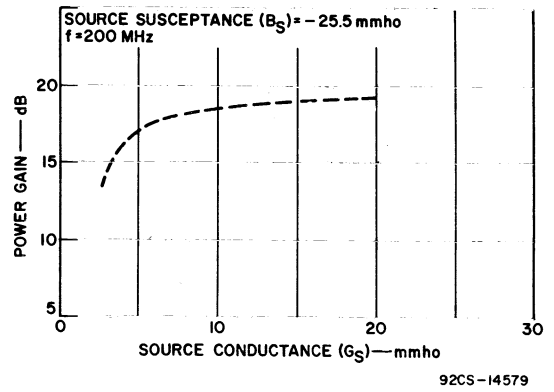

Fig.11 - Power gain as a function of conductance; type 7895 operated as a neutralized grid-drive amplifier tube.

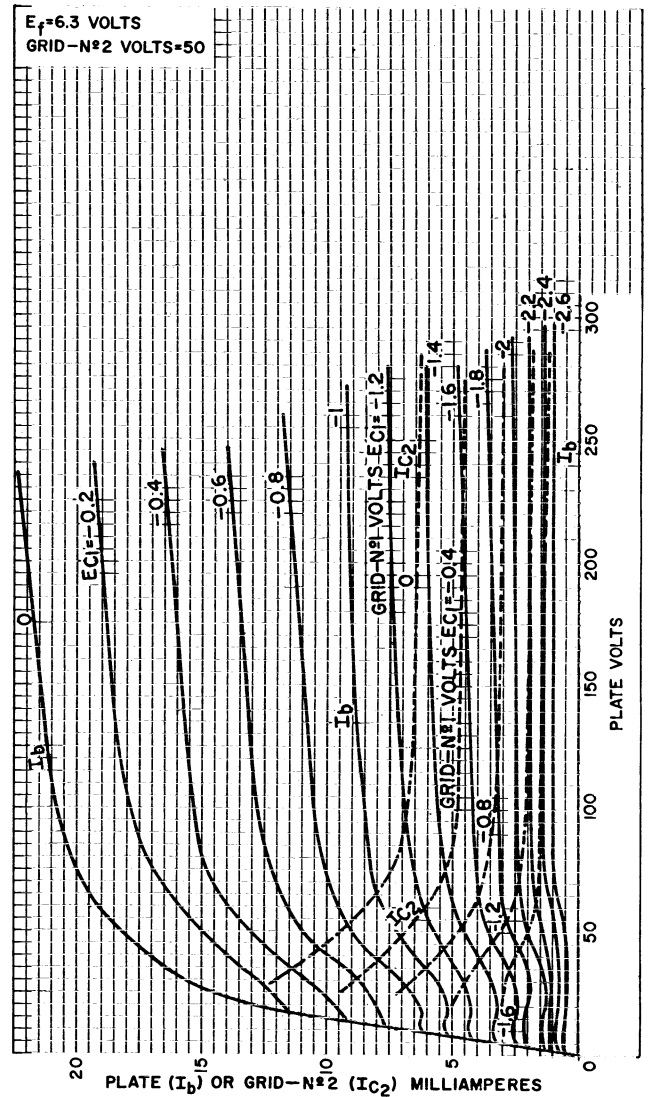

Fig.13 - Typical characteristics, type 7587.

the input and output networks are matched to a 50-ohm signal generator and a 50-ohm load impedance are shown in Figure 11.

IF-Amplifier Service

The design of video if-amplifier systems that use nuvistor triodes is discussed in RCA publication ST-2013.² Although written for television applications of nuvistor type 6CW4, the material is equally relevant to types 7895, 7586, or the low-voltage type 8056.

Audio-Preamplifier Service

Type 8628 is especially useful in condenser-microphone preamplifiers, and piezoelectric- and ceramic-pickup preamplifiers. When operated in the high-input-impedance cathode-follower circuit shown in Figure 12, the following typical values are obtained:

$$R_o \text{ (for } R_i \approx 1 \text{ G}\Omega) \approx 7 \text{ k}\Omega$$

$$I_{c(av)} = -0.1 \text{ nA, } I_{b(av)} = 0.3 \text{ mA.}$$

NUVISTOR TETRODE 7587

The use of a top cap for the plate connection of the 7587 sharp-cutoff tetrode provides excellent input-to-output isolation, low grid-No.1-to-plate capacitance (0.015 pF max.), and low output capacitance (1.4 pF). The low heater current of 150 milliamperes, the high transconductance of 10,600 micromhos at 10 milliamperes of plate current, and the small size of the 7587 make this tube particularly useful for general industrial and military applications, particularly in rf-amplifier, video-amplifier, and mixer service. Figure 13 shows the typical characteristics curves for type 7587; the electrical characteristics and maximum ratings of the 7587 are shown in Table V. The weight of the 7587 is approximately 2.4 grams.

IF-Amplifier Design

A simple five-stage, 60-MHz if amplifier that uses the type 7587 nuvistor is discussed in RCA publication AN-193.³ This amplifier has four staggered, single-tuned stages, a bandwidth of 8 MHz, and the gain-bandpass characteristics shown in Figure 14.

Gain-Bandwidth Product

The bandwidth figure of merit (GB) for a tetrode is given by

$$GB = \frac{g_m}{2\pi(C_i + C_o)}$$

The RCA 7587 has a cold input capacitance (C_i) of 6.5 pF, a cold output capacitance (C_o) of 1.4 pF, and a transconductance (g_m) of 10,600 micromhos. Substitution of these values in the above formula produces a

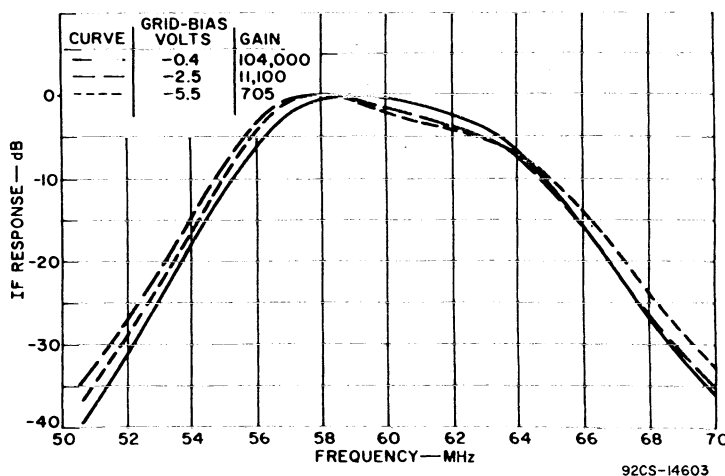

Fig. 14 - Gain-bandpass characteristics of a 5-stage, 60-MHz if amplifier utilizing type 7587.

TYPE	CLASSIFICATION	RCA Dark Heater		CHARACTERISTICS, Class A ₁ Amplifier								MAXIMUM RATINGS Absolute-Maximum Values For Operation at Any Altitude							MAXIMUM CIRCUIT VALUES		
		E _h	I _h	E _{bb}	E _{cc2}	R _k	r _p	g _m	I _b	I _{c2}	E _{c1(co)} for I _b = 10 μA	E _{bb}	E _b	-E _{c1}	e _{c1}	I _{c1}	I _k	P _b	e _{hkm}	Fixed Bias	Cathode Bias
		V	A	V	V	Ω	kΩ	μmho	mA	mA	V	V	V	V	mA	mA	W	V	MΩ	MΩ	
7587	Sharp-Cutoff Tetrode	6.3	0.150	125	50	68	200	10600	10	2.7	-4.5	330	250	55	2	2	20	2.2	±100	0.5 ^c	1 ^c
											E _{cc2} = 330 V, E _{c2} = 110 V, P _{c2} = 0.2 W										

Table V - Electrical data for nuvistor tetrode 7587.

² K.W. Angel and J. Gote, "The Nuvistor Triode in Video IF-Amplifier Circuits," reprinted from IRE Transactions on Broadcast and Television Receivers, July 1961.

³ "Use of the RCA-7587 Industrial Nuvistor Tetrode in RF and IF Applications", December, 1961.

typical operating data are given for frequencies up to 1.2 GHz, useful operation is obtainable at even higher frequencies.

The 8627 and A15526 weigh approximately 2.2 and 2.9 grams, respectively. Typical characteristics curves for the 8627 and the A15526 are shown in Figures 17 through 20. The grid-circuit-resistance rating chart for these types and the grid-dissipation rating chart for the A15526 are shown in Figures 21 and 22.

Class C nuvistors can operate together in a chain, with the 8627 as an oscillator and frequency multiplier tube and as either a power output tube or a driver tube for the A15526. The A15526 may be used as a frequency multiplier tube, power output tube, or a driver tube for an RCA Cermalox power tube, such as the 6816 or the 7842.

The chart on page 16 shows electrical data maximum ratings, and typical operating data for the 8627 and A15526. For pulsed peak cathode current limits on the class C types, see the pulse rating chart, Figure 23; for the A15526 curve of plate- and grid-seal-to-chassis temperature as a function of plate dissipation, see Figure 24.

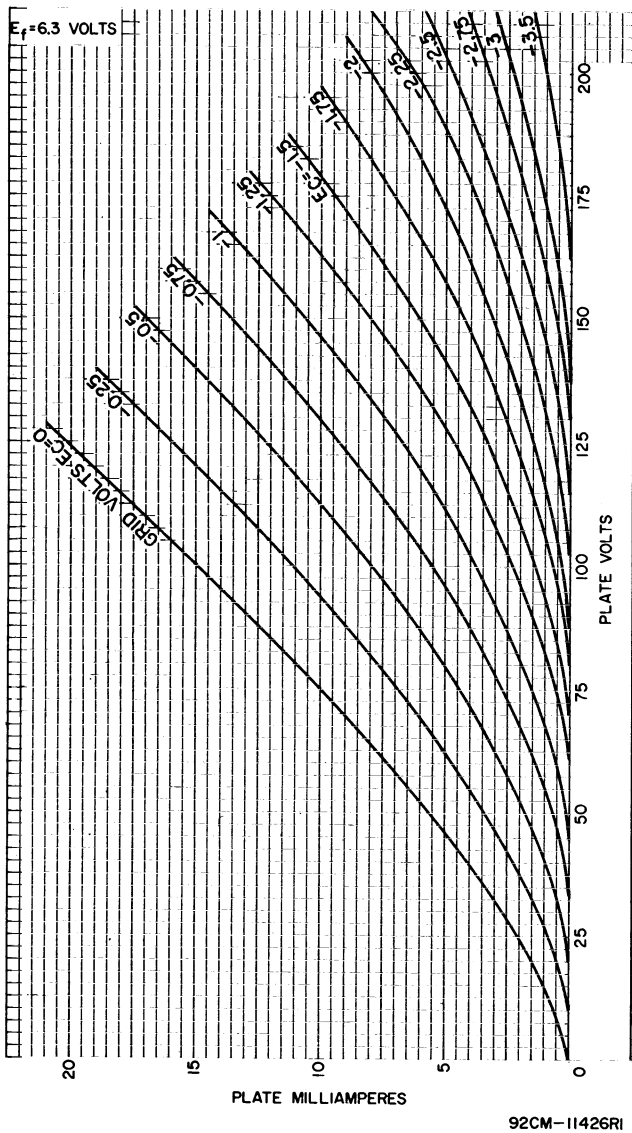

Fig.16 - Typical plate characteristics, type 8058.

The RCA 8627 is a double-ended power triode especially useful in cathode-drive low-level class C rf-power-amplifier, oscillator, or frequency-multiplier applications at frequencies up to 1.2 GHz. Features of the 8627 include typical useful power outputs at 1 GHz of 1.4 watts as a class C amplifier, 1.25 watts as an oscillator, and 0.7 watt as a frequency doubler.

Developmental type A15526 is a high-mu, double-ended nuvistor triode intended for low-power class C service. This nuvistor is especially suitable for CW or grid-pulse operation as a power amplifier, oscillator, or frequency multiplier at frequencies up to 1.2 GHz.

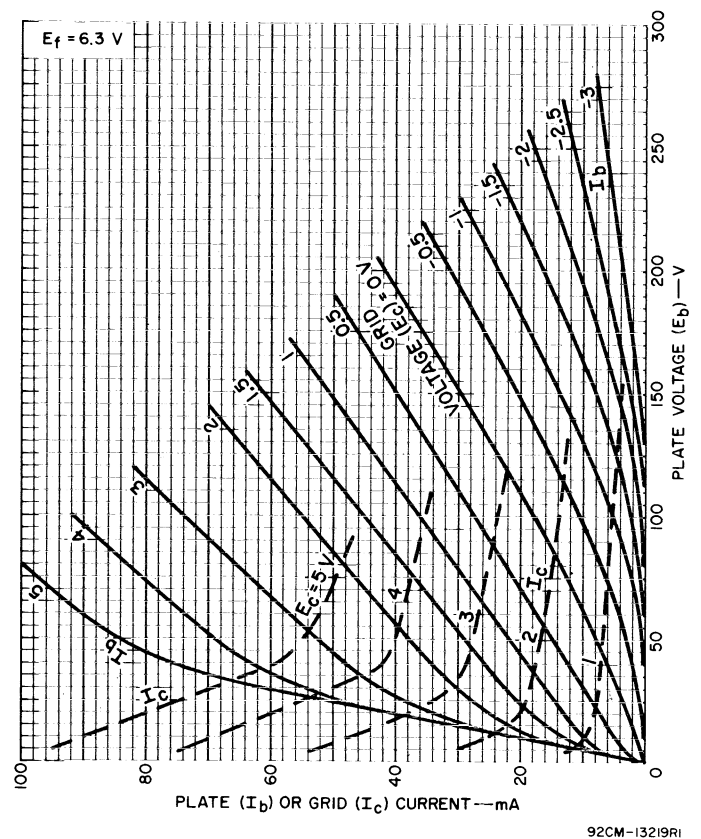

Fig.17 - Typical characteristics, type 8627.

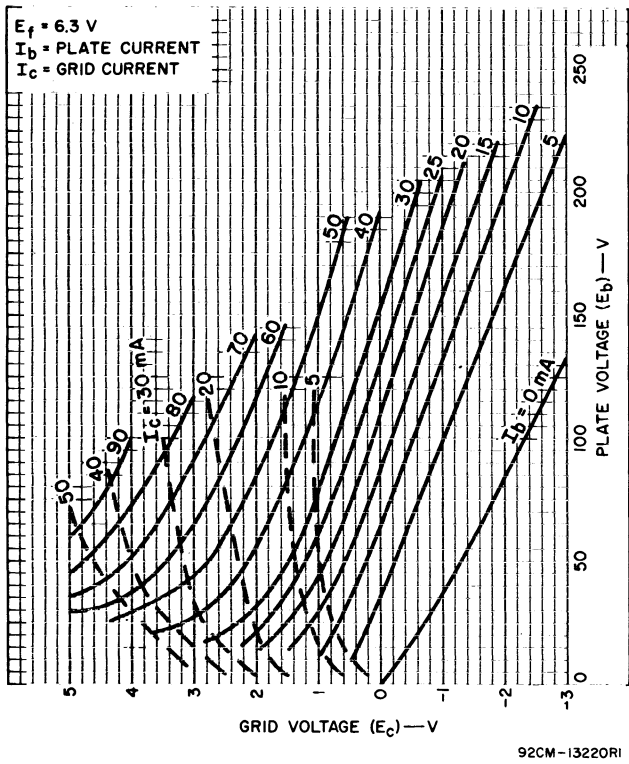

Fig.18 - Typical constant-current characteristics, type 8627.

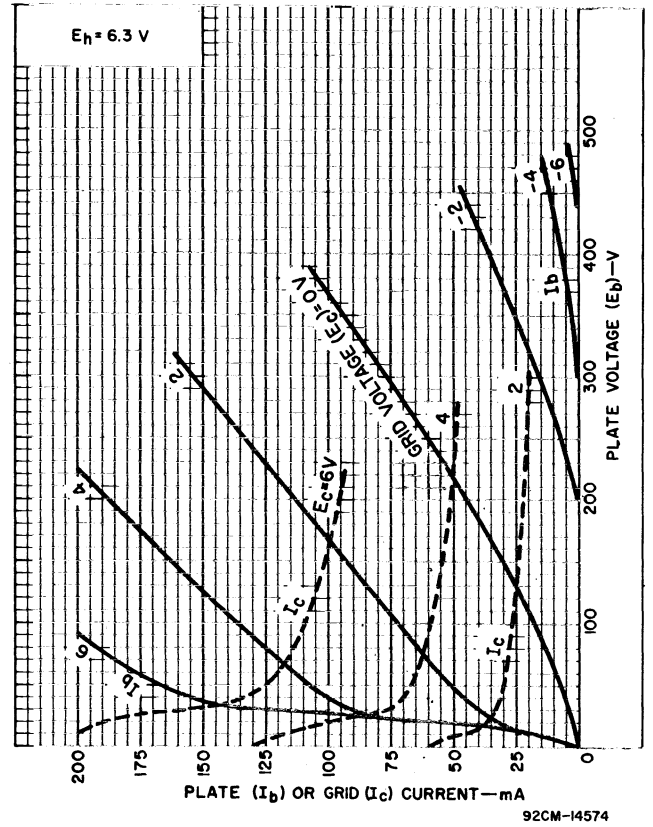

Fig.19 - Typical characteristics, dev. type A15526.

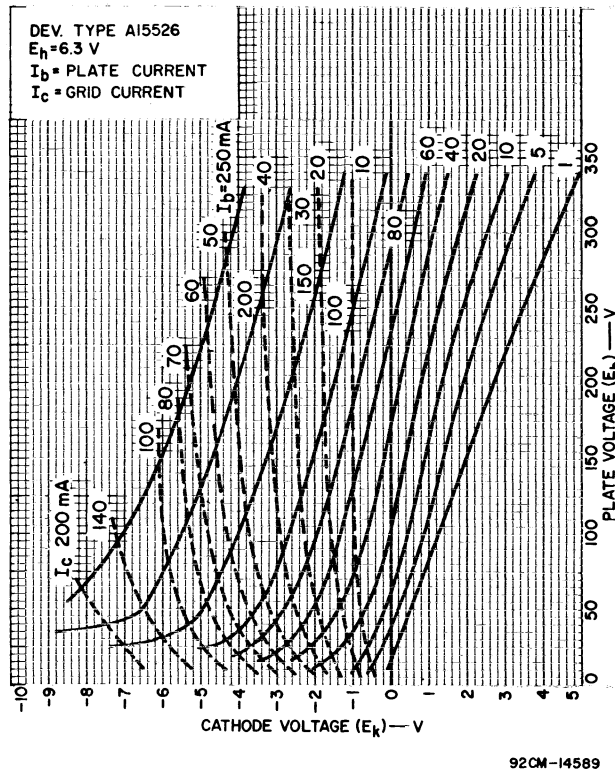

Fig.20 - Typical grounded-grid constant-current characteristics, dev. type A15526.

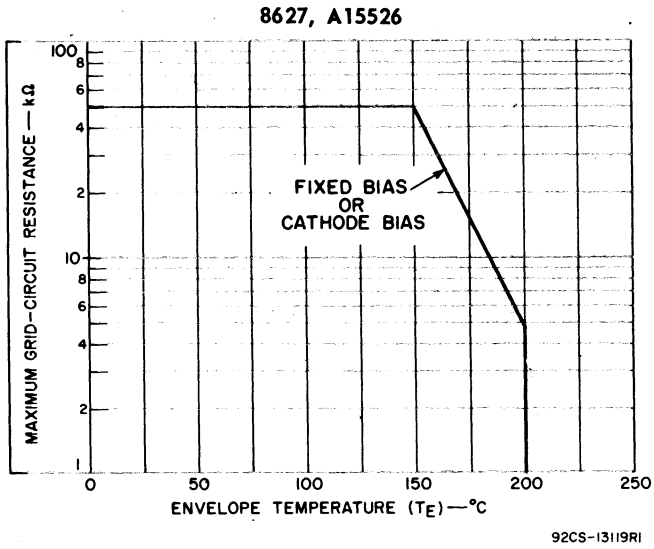

Fig. 21 - Grid-circuit-resistance rating chart.

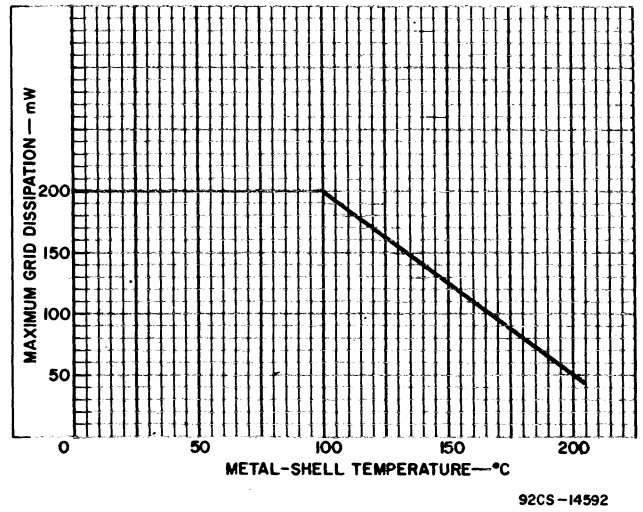

Fig. 22 - Grid-dissipation rating chart, dev. type A15526.

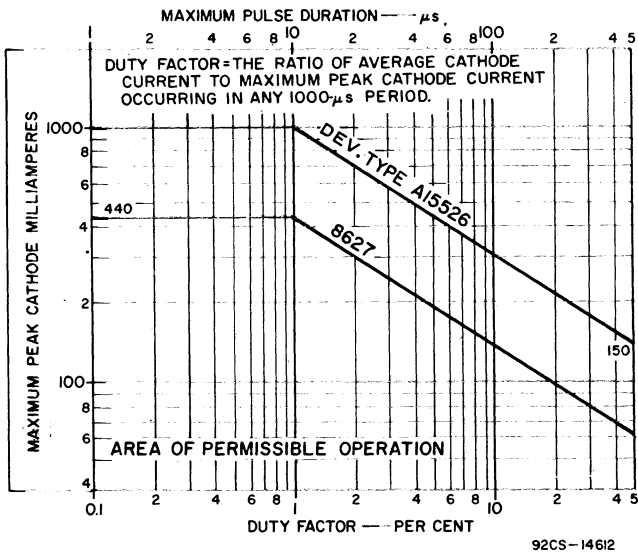

Fig. 23 - Pulse rating chart, type 8627 and dev. type A15526 - based on typical pulse rating chart shown in "A Guide for Pulse Rating Low Power Vacuum Tubes", JEDEC Publication No. 41, September, 1963.

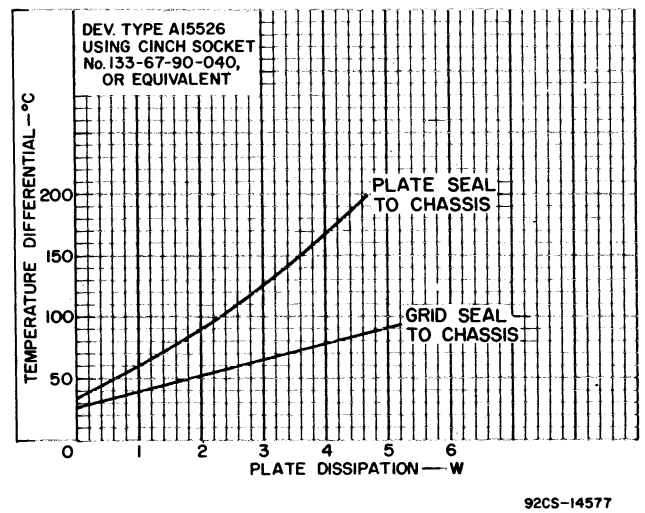

Fig. 24 - Temperature differentials, from plate seal to chassis and grid seal to chassis, as functions of plate dissipation, dev. type A15526.

NUUVISTORS FOR CLASS C SERVICE - 8627, A15526

ELECTRICAL DATA

	8627	Dev. Type A15526		
Heater Voltage, dc or ac E_h	6.3	6.3	6.3	V
Heater Current at $E_h = 6.3$ V. . . I_h	150	340	340	mA
Direct Interelectrode Capacitances: ^k				
Input: K to (G,S,H) c_i	6.0	9.6	9.6	pF
Output: P to (G,S,H) c_o	1.2	2.7	2.7	pF
Heater to cathode c_{hk}	1.4	2.6	2.6	pF
Cathode to plate c_{kp}	-	0.050	0.050	pF
<i>For the following characteristics, see Conditions below:</i>				
Amplification Factor μ	60	70	100	
Plate Resistance (Approx.) r_p	6300	5400	6400	Ω
Transconductance g_m	9500	13000	18000	μ mho
DC Plate Current I_b	9	11.5	15	mA
Cutoff DC Grid Voltage: $E_c(\text{co})$				
For $I_b = 10 \mu\text{A}$ -	-	-5	-	V
For $I_b = 100 \mu\text{A}$ -	-	-	-5	V
<i>Conditions:</i>				
Heater Voltage E_h	6.3	6.3	6.3	V
Plate Supply Voltage E_{bb}	150	110	200	V
Grid Supply Voltage E_{cc}	0	0	0	V
Cathode Resistor R_k	150	47	68	Ω

TYPICAL OPERATION - CCS

As cathode-drive rf power amplifier

	8627	Dev. Type A15526		
Frequency f	1	1	1	GHz
Heater Voltage E_f	6.3	6.3	6.3	V
DC Plate-to-Grid Voltage E_{bg}	180	206	206	V
DC Cathode-to-Grid Voltage . . E_{kg}	5.5	5.8	5.8	V
From grid resistor of R_g	1200	300	300	Ω
Average Plate Current $I_{b(\text{av})}$	20	50	50	mA
Average Grid Current $I_{c(\text{av})}$	4.5	19	19	mA
Driving Power (Approx.) P_g	0.15	1	1	W
Useful Power Output (Approx.) ^q $P_{o(\text{useful})}$	1.4	5	5	W

As cathode-drive frequency doubler

	8627	Dev. Type A15526		
Output Frequency f_o	1	1.2	1.2	GHz
Heater Voltage E_f	6.3	6.3	6.3	V
DC Plate-to-Grid Voltage E_{bg}	180	200	200	V
DC Cathode-to-Grid Voltage . . E_{kg}	8.5	11	11	V
From grid resistor of R_g	1200	1000	1000	Ω
Average Plate Current $I_{b(\text{av})}$	18.5	38	38	mA
Average Grid Current $I_{c(\text{av})}$	3	10.5	10.5	mA
Driving Power (Approx.) P_g	0.3	1	1	W
Useful Power Output (Approx.) ^q $P_{o(\text{useful})}$	0.7	2	2	W

MAXIMUM RATINGS - Absolute-Maximum Values

For operation as a Low-Level Class-C RF-Power-Amplifier, Oscillator, or Frequency-Multiplier Tube at frequencies up to 1.2 GHz

	8627	Dev. Type A15526		
	CCS ^m	ICAS ⁿ	ICAS	
Plate Supply Voltage E_{bb}	600	600	1000	V
DC Plate Voltage E_b	250	300	1000	V
Grid Voltage:				
Peak e_{cm}	4	5	30	V
DC E_c	+0	+0	+0	V
	-100	-100	-100	V
Peak Heater-Cathode Voltage . e_{hkm}	± 100	± 100	± 100	V
Average Grid Current $I_{c(\text{av})}$	5	6	-	mA
Average Cathode Current $I_{k(\text{av})}$	25	30	75	mA
Grid Dissipation P_g	-	-	200 ^P	mW
Plate Dissipation P_b	2.5	2.7	6	W
Envelope Temperature T_E	200	200	200	$^{\circ}\text{C}$

MAXIMUM CIRCUIT VALUES

	CCS	ICAS	ICAS	
Grid-Circuit Resistance: $R_{g(\text{ckt})}$				
For fixed-bias or cathode-bias operation:				
For $T_E \leq 150^{\circ}\text{C}$ -	50	50	50	k Ω
For $T_E > 150^{\circ}\text{C}$ and $< 200^{\circ}\text{C}$ -	See Grid-Circuit-Resistance Rating Chart			

TYPICAL OPERATION

As pulsed cathode-drive rf power amplifier (engineering test)

	8627	Dev. Type A15294C ^r		Dev. Type A15526		
Output Frequency f_o	1	1	1	1	1	GHz
DC Plate-to-Grid Voltage E_{bg}	1000	1000	1000	1000	1000	V
DC Cathode-to-Grid Voltage . . E_{kg}	35	20	20	20	20	V
Average Plate Current $I_{b(\text{av})}$	1.5	4.75	4.75	4.75	4.75	mA
Average Grid Current $I_{c(\text{av})}$	0.4	2.4	2.4	2.4	2.4	mA
Duty Factor -	1	1	1	1	1	%
Pulse Length -	5	5	5	5	5	μs
Peak Driving Power (Approx.) . -	10	50	50	50	50	W
Peak Useful Power Output (Approx.) -	70	240	240	240	240	W

^k Measured without external shield in accordance with the current issue of EIA Standard RS-191.

^m Continuous Commercial Service.

ⁿ Intermittent Commercial and Amateur Service. No operating or ON period exceeds 5 minutes and every ON period is followed by an OFF or standby period of the same or greater duration.

^P For operation at metal-shell temperatures up to 100^o C. For operation at other metal-shell temperatures, see Grid-Dissipation Rating Chart.

^q Measured at load.

^r This developmental type is like the 8627 except for a 1000-volt maximum rating on both Plate Supply Voltage and DC Plate Voltage.

WARM-UP TIME

Typical cathode-current warm-up time as a function of heater voltage for nuvistors is shown in Figure 25. In this curve, cathode-current warm-up time is the time for the tube to reach 80 per cent of normal conduction. Normal production tolerances will cause minor deviations from this curve. At $E_h = 6.3$ V, warm-up time is approximately 13 seconds.

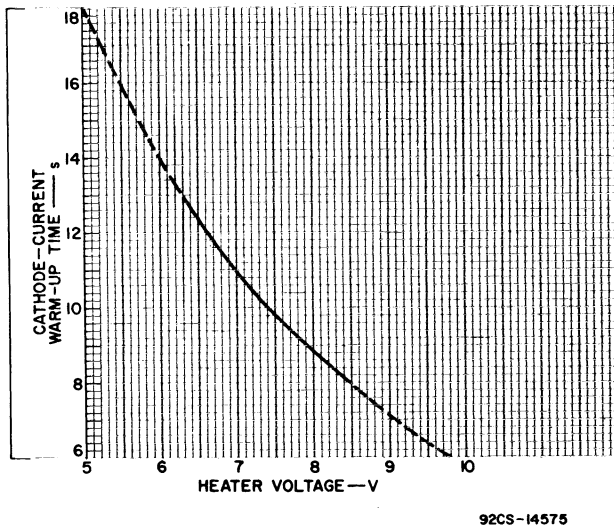

Fig. 25 - Cathode-current warm-up time as a function of heater voltage.

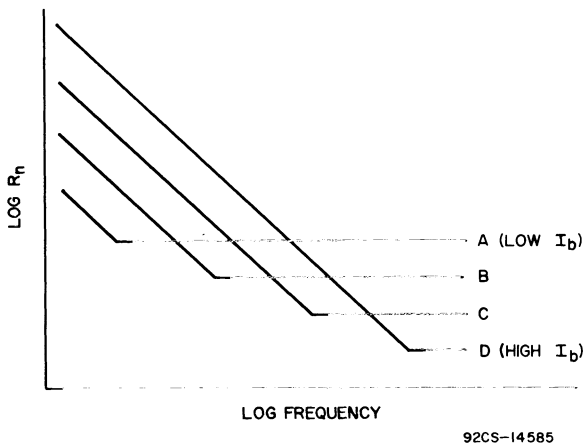

Fig. 26 - Generalized relationship between electron-tube equivalent noise resistance and frequency for different levels of plate current.

NOISE

Noise in electron tubes arises primarily from three different phenomena: shot noise, caused by the random arrival of electrons at the anode; induced grid noise, due to currents induced in the grid circuit by the random transit of electrons through the grid; and flicker noise, from random variations in cathode activity. Above 30

MHz, induced grid noise is predominant. Flicker noise, which has a $1/f$ characteristic, predominates in the sub-audio region. Shot noise is relatively independent of frequency.

Low-Frequency Noise

The optimum conditions for good flicker noise performance are different from the conditions for optimum shot noise performance, as shown in Figure 26, a generalized representation of low-frequency noise in electron tubes. Curves A through D represent increasing plate current, while the frequency scale represents approximately 10 Hz to 100 kHz. At sub-audio frequencies, the flicker noise is greatest at high levels of plate current. Types 7586 and 7895 display excellent flicker noise characteristics. Figures 27 and 28 represent equivalent flicker noise resistances at 10 Hz for typical 100-tube lots of each of these nuvistors, at optimum operating conditions for each type.

Equivalent shot-noise resistances in the order of 200 to 300 ohms have been observed for types 7586 and 7895 at approximately 455 kHz under optimum conditions, with plate voltage approximately 20 to 30 volts and grid bias voltage approximately 0.25 volt.

The nuvistors display noise performance superior to that of the transistor when each is driven from a high resistance source ($R_s > 500 \Omega$), such as a vidicon camera tube (which acts like a constant-current generator) or an untuned loop antenna.

RF Noise

The basic single-ended nuvistors triode has a useful operating range in excess of 400 MHz. The double-ended triodes utilize the shell to provide a low-inductance grid-to-ground connection, and have a useful frequency range of 200 MHz to above 1200 MHz. The tetrode is useful up to 200 MHz, but has added partition noise from the screen grid. For this reason, the noise of the tetrode is usually defined by the equivalent noise resistance, while for the other types it is defined in terms of noise figure, usually at 200 MHz for comparison purposes.

Figure 29 shows noise figure as a function of frequency for several nuvistors triodes operated under noise-matched conditions at a plate current of 7 to 10 mA. Typical noise-figure values are shown for the 7586, 7895, and 8056 from 30 MHz to 450 MHz. The noise-figure data shown for frequencies above 450 MHz were obtained for an 8058 nuvistors operated in a grounded-grid configuration without neutralization. These data include the increase in noise figure that results from input circuit losses and represent practical values rather than theoretical tube values.

At rf frequencies below 30 MHz the circuit noise, particularly the noise induced by grid current, becomes a strongly contributing factor, because the real portion

of the circuit impedance is often high. The optimum noise point is generally located in the -0.25 to -1.3-volt-bias region, depending on the frequency, with plate current of 6 to 12 mA. The basic triode has an equivalent noise resistance of 200 to 500 ohms under these

for the 8058, occurs between 8 and 12 mA in all four types, with the plate voltage in each case proportional to the μ . Typical range of E_b and I_b values for optimum noise performance are:

	8056	7586	7895	8058	
E_b	12-30	45-75	75-125	75-150	V
I_b	8-12	8-12	8-12	8-12	mA

The typical noise contour for the 8056, shown in Figure 30, can also be applied to the 7586, 7895, and 8058, with appropriate changes in the plate voltage scale within the range of values shown above.

Description of Measuring Circuit

The test circuit used for obtaining the noise contours for the 8056 is shown in Figure 31. The circuit

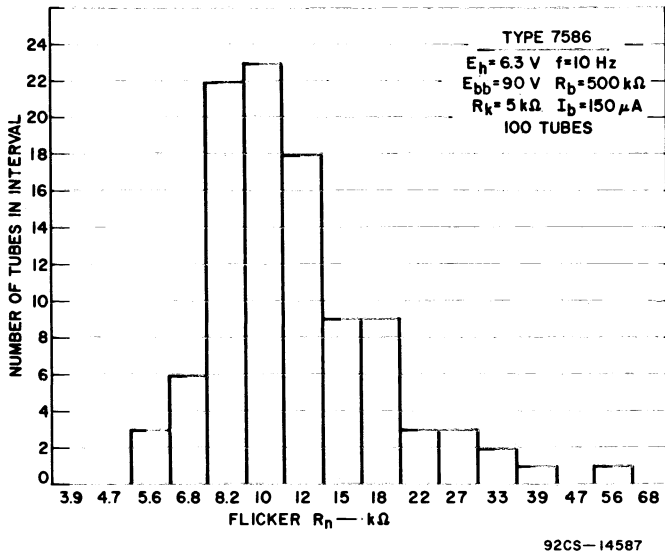

Fig.27 - Equivalent flicker noise resistance at 10 Hz, type 7586.

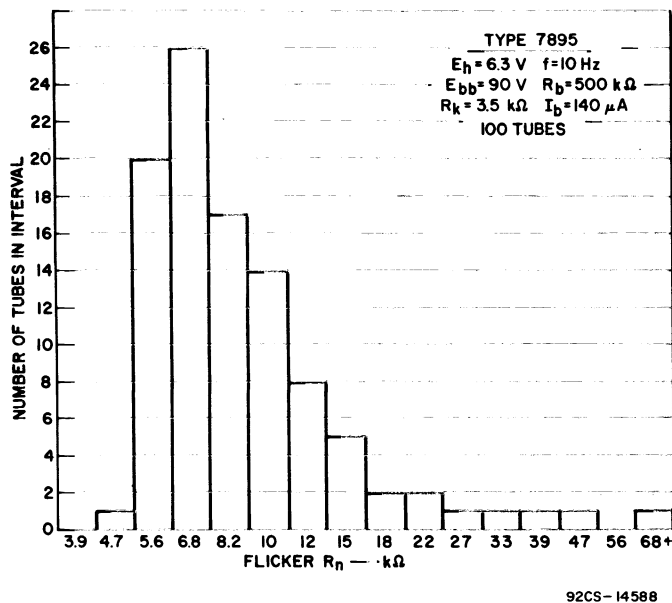

Fig.28 - Equivalent flicker noise resistance at 10 Hz, type 7895.

conditions. The 7587 tetrode has a typical equivalent noise resistance of about 1500 ohms. The higher value of noise for the tetrode is due to partition noise, caused by the random division of cathode current between the anode and the screen grid.

Optimum noise in the 90 to 400 MHz region for the 7586, 7895, and 8056, and the 400 to 1200 MHz region

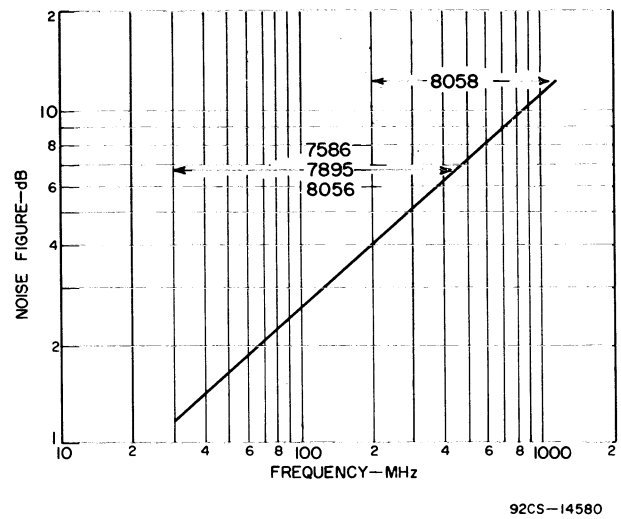

Fig.29 - Noise figure as a function of frequency, types 7586, 7895, 8056, 8058.

consists of a partially neutralized grounded-cathode amplifier stage which has a bandwidth of approximately 4 MHz. The output of the amplifier is matched to a 50-ohm load through a pi network; a similar network is used to adjust the source admittance for minimum noise figure.

INPUT CHARACTERISTICS

Grid Current

In normal operation, the grid current of the nuvistors is usually very low, in the order of 1 nanoampere or less. Contact potential of 1.0 to 1.2 volts is very stable from tube lot to tube lot. Figure 32 shows typical grid-current curves for the 7586, 7895, and 8056. Even lower values of grid current can be expected for the 8628, which is specifically designed to minimize grid emission.

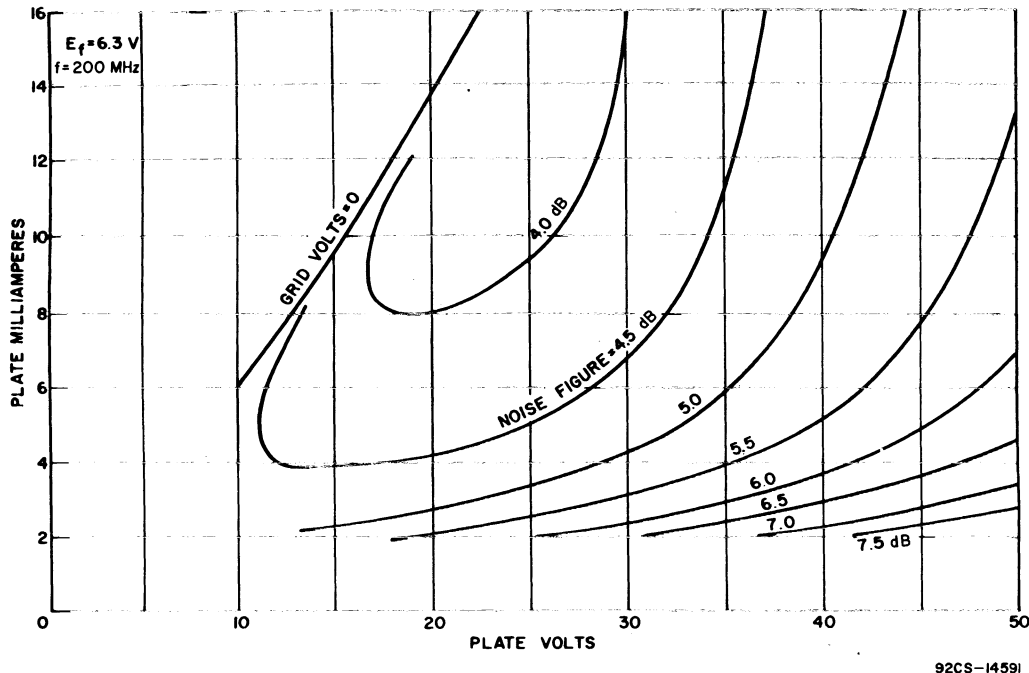

92CS-1459I

Fig.30 - Noise figure at noise match, type 8056.

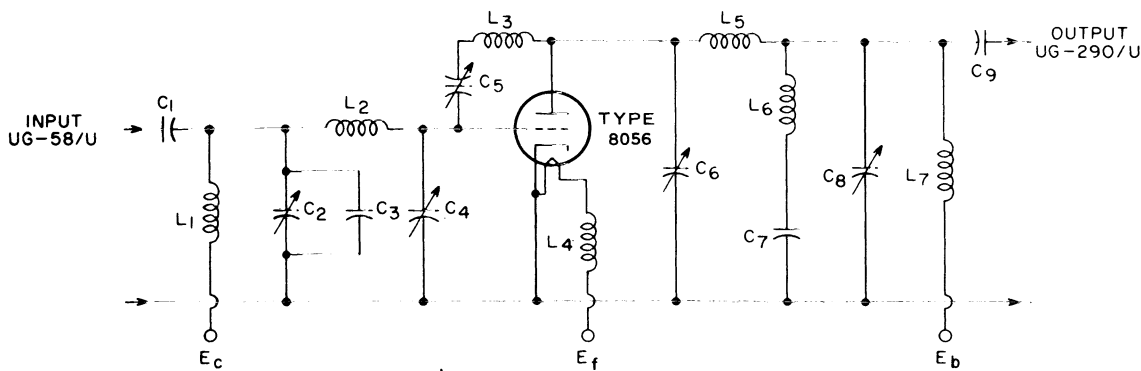

92CM-14590

- C₁ - 2200 pF, uncoated disc ceramic, soldered directly on input connector
- C₂ - Hammarlund APC-50
- C₃ - 22 pF, tubular ceramic
- C₄ - E.F. Johnson 5 M11
- C₅ - E.F. Johnson 9 MB11
- C₆ - E.F. Johnson 9 M11
- C₇ - 2200 pF, uncoated disc ceramic, soldered directly on chassis
- C₈ - Hammarlund APC-25
- C₉ - 2200 pF, uncoated disc ceramic, soldered directly on output connector

- L₁, L₄, L₇ - Ohmite rf choke, Z-235
- L₂ - 1 loop of No.14 magnet wire 9 cm long, bent to form a U 2 cm wide, 1 to 2.5 cm from chassis
- L₃ - B & W Miniductor 3002, 5-1/2 turns
- L₅ - 5 cm of No.14 magnet wire, slightly bent, 1.8 cm from chassis
- L₆ - silvered strap 0.4 cm wide, 2.5 cm long, bent to form a U 1 cm wide

Chassis 5-1/2" long, 4" wide, 1-1/2" deep, of 0.024" copper tinned on the wiring side, partitioned to the full depth 2-1/2" from the input wall. The partition cuts across the center of the socket and is sliced 1/16" into the socket. Neutralizing coil L₃ and capacitor C₄ are mounted on the grid side of the partition and partially shielded from the input circuit.

Fig.31 - Test circuit for obtaining noise contours for type 8056.

Input Conductance and Susceptance

The single-ended triodes 7586, 7895, and 8056 have a socketed input resonant frequency of approximately 610 MHz, with inductance of 8 nH in the socket pins and 8.5 pF inter-pin capacitance. The curves in Figure 33 show typical values of input conductance and susceptance as functions of frequency, when the 7586, 7895, and 8056 are operated in the plate current range of 8 to 10 mA.

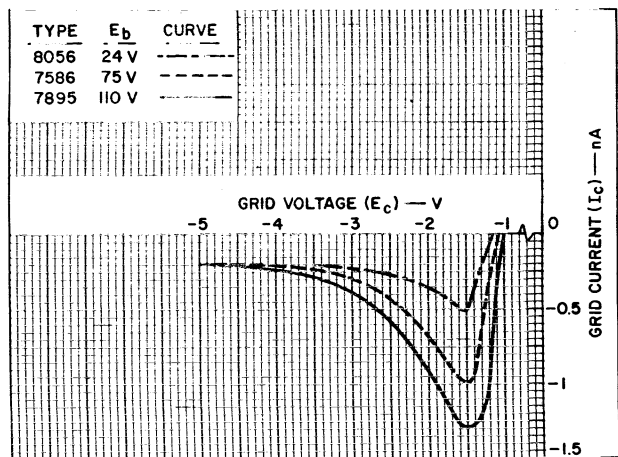

92CS-14578

Fig.32 - Typical values of grid current as functions of grid voltage, types 7586, 7895, 8056.

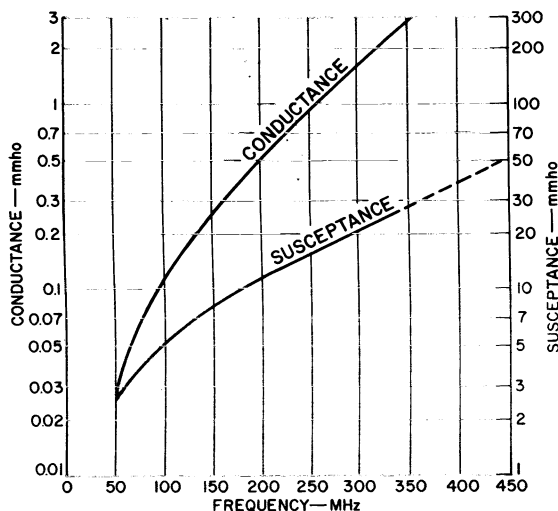

92CS-14583

Fig.33 - Typical values of conductance and susceptance as functions of frequency, types 7586, 7895, and 8056.

When the current through a tube is varied, as it may be to control the gain of an amplifier stage, variations in the input conductance and input capacitance affect the gain-frequency characteristics of the circuit connected to the input of the tube. Table IX shows the values of short-circuit input capacitance and short-

circuit input conductance of type 7587 for normal operating conditions, plate-current cutoff conditions, and with the tube cold. These values were measured in a socket at a frequency of 60 MHz. The input capacitance values are independent of frequency up to approximately 150 MHz.

Operating Condition	Input Capacitance (pF)	Input Conductance (μ mho)
Tube operating ($I_b = 10$ mA)	9.0	100
Tube cut off ($I_b = 0$)	7.7	18
Tube cold (no heater voltage applied)	7.1	17
Change from cutoff to $I_b = 10$ mA	1.3	82
Change when heater voltage is applied	0.6	-

Table IX - Variation of short-circuit input capacitance and input conductance at 60 MHz, type 7587.

Transit-Time Estimates

The calculation of transit time of the electron in a vacuum tube is generally based on these assumptions:

- (1) Electron velocity at the cathode is zero.
- (2) Tube geometry is uniform for all electron paths.

Although these assumptions are somewhat unrealistic, the calculated values of transit time do provide a basis for comparison of different tube constructions.

The velocity of an electron with one electronvolt kinetic energy is 6×10^7 centimeters-per-second at grid No.1, and the velocity varies with the square root of the energy in electronvolts.

The average velocity under space-charge-limited conditions, for an initial velocity of zero and ideal parallel-plane geometry, is one-third the final velocity. The average velocity when space charge can be neglected, with parallel plane geometry, is the mean of the initial and the final velocity.

Examples of transit-time calculations are given in Table X. Grid-No.1 wire diameter (0.0008 in) was disregarded in the calculations because it has very little effect on the results.

For the tetrode 7587, the cathode-grid-No.2 time is probably most significant with respect to input loading and noise. The total transit time is important when feedback is considered.

Under the assumptions used, the expected phase delay of the plate current with respect to the cathode-to-grid voltage is 2/3 of the total transit time, or 2×10^{-10} seconds for the example shown for type 7586. This delay corresponds to a phase angle delay of 1/4 cycle (90°) at 1250 MHz.

Because the current varies as the grid voltage raised to the 3/2 power, if the effective voltage at the grid is increased 4 times, the current is increased 8

times, and the transit time is halved. It may be noted that moderate changes in current density will not change the transit time substantially.

Dimensions	7586	7895	7587	
Coated cathode O.D.	0.062	0.062	0.062	in
Grid No.1 I.D.	0.066	0.066	0.066	in
Plate I.D.	0.080	0.102	0.248	in
Grid No.2 I.D.	-	-	0.077	in
Spacings				
Cathode-grid No.1	0.002 (0.005)	0.002 (0.005)	0.002 (0.005)	in cm
Grid No.1-plate	0.007 (0.018)	0.018 (0.045)	-	in cm
Grid No.1-grid No.2	-	-	0.0055 (0.014)	in cm
Grid No.2-plate	-	-	0.086 (0.215)	in cm

Assuming 1 electronvolt (eV) energy at grid No.1 and 100 eV at the plate; and for the 7587, 50 eV at grid No.2:

Velocity				
At grid No.1	6×10^7	6×10^7	6×10^7	cm/s
At plate	6×10^8	6×10^8	6×10^8	cm/s
At grid No.2	-	-	4×10^8	cm/s
Average, cathode-grid No.1	2×10^7	2×10^7	2×10^7	cm/s
Average, grid No.1-plate	3.3×10^8	3.3×10^8	-	cm/s
Average, grid No.1-grid No.2	-	-	2.3×10^8	cm/s
Average, grid No.2-plate	-	-	5×10^8	cm/s

Time				
Cathode-grid No.1 ^s	2.5×10^{-10}	2.5×10^{-10}	2.5×10^{-10}	s
Grid No.1-plate	0.5×10^{-10}	1.4×10^{-10}	-	s
Grid No.1-grid No.2	-	-	0.7×10^{-10}	s
Grid No.2-plate	-	-	4.3×10^{-10}	s
Total transit time ^s	3×10^{-10}	3.9×10^{-10}	7.5×10^{-10}	s

^s For type 7895, with 200 eV at the plate, cathode-grid-No.1 time is 1×10^{-10} s and total transit time is 3.5×10^{-10} s.

Table X - Transit-time calculations for the 7586, 7895, and 7587 nuvistors.

CROSS MODULATION

The cross-modulation characteristic indicates the capability of a tube to handle large interfering signals. Figure 34 shows the rms voltage of a 30%-modulated interfering signal at the grid of the tube which results in 1% of the modulation signal being transferred to the desired carrier. Cross-modulation curves are shown for the 8056 and 7895. Although a curve for the 7586 is not shown, its performance curve is between that of the 7895 and the 8056.

OPERATING PRECAUTIONS

To realize fully the reliability and long life of the nuvistor, adequate care must be exercised in the choice of operating parameters so that the tube remains within its maximum ratings, established for normal variations of line and/or power supply voltages. The nuvistor is conservatively rated to cover the widest possible choice of circuits. If it should be necessary, however, to exceed a rating in a specific circuit, an RCA field representative should be consulted. In such cases, technical approval of operation "out of ratings" should be obtained from the RCA field representative in order to maintain existing warranties.

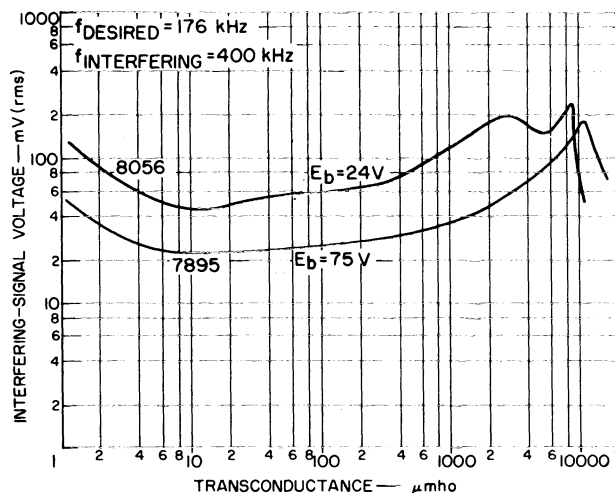

92CS-1458I

Fig.34 - 1% cross-modulation characteristics, types 7895 and 8056.

When the nuvistor is operated at positive grid voltages, the peak positive grid-to-cathode voltage rating should be observed. In all close-spaced, high-transconductance electron tubes rapid cathode poisoning can occur if the positive grid rating is exceeded. For applications that require high values of peak grid to cathode voltage, use of the class C nuvistor types should be considered.

The relatively small mass of the nuvistor heater, as compared to that of other vacuum tubes, contributes to a peculiar vibration phenomena that can produce extraneous signals in extremely sensitive low-level signal applications. In such applications, when vibration environments exist, shock mounting is recommended.

Finally, for maximum reliability it is recommended that full advantage be taken of the conduction-cooled structure of the nuvistor, and that proper thermal contact between tube and chassis be assured, particularly when tubes are operated at maximum dissipations.

ADDITIONAL TECHNICAL INFORMATION

Additional technical information about the commercial RCA nuvistor tubes included in this booklet is available from your nearest RCA Field Sales Office or from Commercial Engineering, RCA Electronic Components and Devices, Harrison, New Jersey 07029. A technical bulletin for each of the commercial nuvistor types, and the following Application Notes and reprint can be obtained on request:

- AN-193 Use of the RCA-7587 Industrial Nuvistor Tetrode in RF and IF Applications
- AN-195 Noise and Gain of the RCA-8056 Nuvistor Triode at 200 Megacycles
- AN-196 Temperature Ratings and Thermal Considerations for Nuvistor Tubes
- ST-3079 Pulsed Nuclear Irradiation of Nuvistors

For further technical information about nuvistor developmental types, including preliminary and tentative data sheets for a specific type, contact your nearest RCA Field Sales Office or the Marketing Manager, Nuvistors, RCA Electronic Components and Devices, Harrison, New Jersey 07029.

RCA also manufactures the following nuvistor tubes intended for home-entertainment applications: 2CW4, 6CW4, 13CW4; 2DS4, 6DS4; 2DV4, 6DV4; 2EG4. Technical bulletins for these types and reprint ST-2013 (The Nuvistor Triode in Video IF-Amplifier Circuits) are available from the RCA Field Sales Offices or from Commercial Engineering at the above address.

Information furnished by RCA is believed to be accurate and reliable. However, no responsibility is assumed by RCA for its use; nor for any infringements of patents or other rights of third parties which may result from its use. No license is granted by implication or otherwise under any patent or patent rights of RCA.

NUVISTOR-TUBE SOCKET AND CONNECTOR INFORMATION†

NUVISTOR TYPE	SOCKET			
	Mounting	Body Material ^u	Cinch Mfg. Co. ^v No.	Cinch-Jones Sales-Division Distributor No. ^w
7586	Crimp	MFP	133 65 10 001	5NS
7587		DIALL ^x	133 65 92 025	-
7895		TEFLON	133 65 91 034	-
8056	Flange	MFP	133 65 10 003	5NS-1
8393	Printed-Board (Stand-Off)	MFP	133 65 10 009	5NS-2
8058 8627	Crimp	MFP	133 65 10 041	5NS-3
A15526	Crimp	HALON ^y	133 67 90 040	5NS-4
8628	Crimp	DIALL	133 65 92 025	-
		TEFLON ^z	133 65 91 034	-

NUVISTOR TYPE	TOP-CAP CONNECTOR	
7587 8058 8627	Cinch Mfg. Co. ^v No. 422 03 22 017 or 422 03 22 024, or equivalent "1/4-inch" connector.	
A15526	For Distributed-Constant Circuit	International Electronic Research Corp. ^{aa} Therma-Link Retainer Part No. TXBE-032-031G
	For Lumped-Constant Circuit	Wakefield Engineering, Inc. ^{ab} Semiconductor Cooler Type NF207

† Information on sockets or connectors having different materials or finishes may be obtained from the manufacturers listed. Sockets or connectors having comparable mechanical and electrical characteristics may be available from other manufacturers.

^u MFP = general-purpose, low-loss Mica-Filled Phenolic; DIALL = glass-filled Diallyl Phthalate for missile, satellite, and other high-vacuum applications; TEFLON and HALON are for low-rf and low-leakage loss, high-temperature applications.

^v 1026 South Homan Ave., Chicago, Illinois 60624. Tel: (312) NE 2-2000.

^w This number appears in many distributors' catalogs.

^x TRADE MARK: Mesa Plastics Co., Los Angeles, Calif.

^y TRADE MARK: Allied Chemical Corp., Morristown, N.J.

^z TRADE MARK: E.I. DuPont de Nemours & Co., Inc., Wilmington, Del.

^{aa} 135 West Magnolia Blvd., Burbank, Calif. 91502. Tel: (213) 849-2481.

^{ab} 139 Foundry St., Wakefield, Mass. 01880. Tel: (617) 245-5900

TYPES 7586, 7895, 8056, 8393, 8628

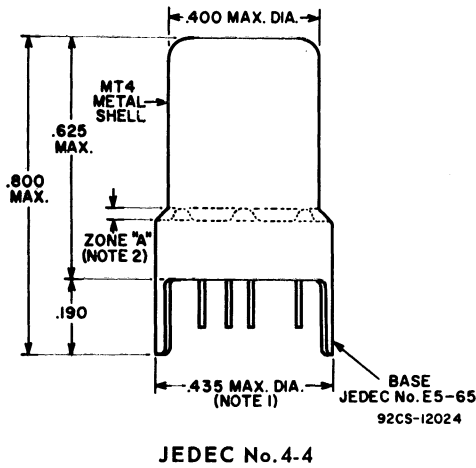

DIMENSIONAL OUTLINES
Dimensions in Inches

TYPE 7587

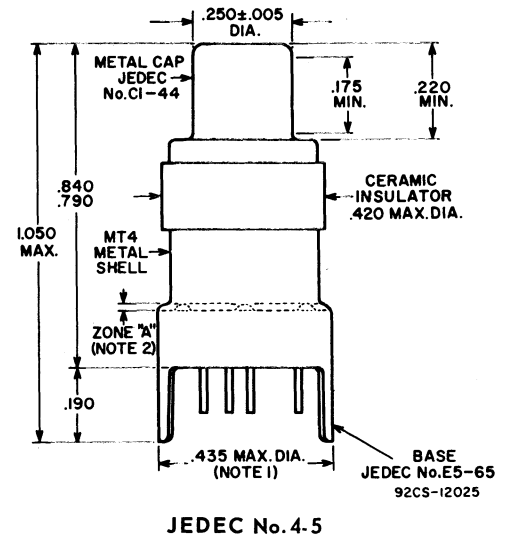

Note 1: Maximum O.D. of 0.440" is permitted along 0.190" lug length.
Note 2: Envelope temperature should be measured in Zone "A".

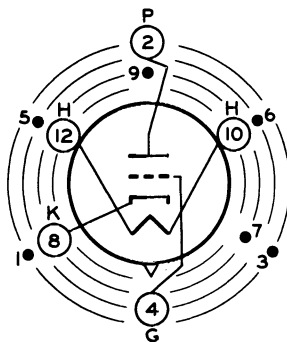

INDEX=LARGE LUG
●=SHORT PIN-IC
JEDEC 12AQ

- | | |
|---------------------|---------------------|
| Pin 1* - Do Not Use | Pin 7* - Do Not Use |
| Pin 2 - Plate | Pin 8 - Cathode |
| Pin 3* - Do Not Use | Pin 9* - Do Not Use |
| Pin 4 - Grid | Pin 10 - Heater |
| Pin 5* - Do Not Use | Pin 12 - Heater |
| Pin 6* - Do Not Use | |

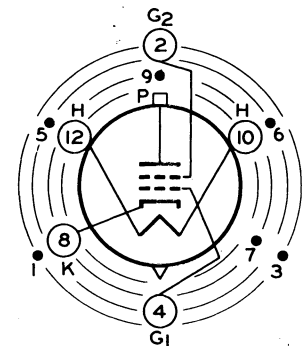

INDEX=LARGE LUG
●=SHORT PIN-IC
JEDEC 12AS

- | | |
|---------------------|---------------------|
| Pin 1* - Do Not Use | Pin 8 - Cathode |
| Pin 2 - Grid No.2 | Pin 9* - Do Not Use |
| Pin 3* - Do Not Use | Pin 10 - Heater |
| Pin 4 - Grid No.1 | Pin 12 - Heater |
| Pin 5* - Do Not Use | Top Cap - Plate |
| Pin 6* - Do Not Use | |
| Pin 7* - Do Not Use | |

* Pin is of a length such that its end does not touch the socket insertion plane.

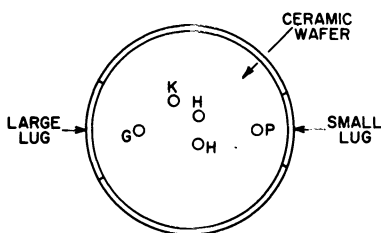

92CS-12161RI

MODIFIED BOTTOM VIEWS
With Element Connections Indicated
and Short Pins Not Shown

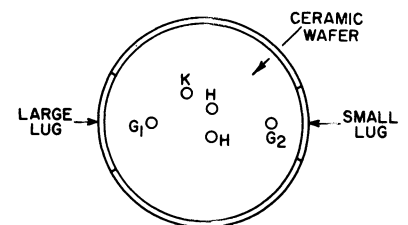

92CS-12163RI

For
SOCKET & CONNECTOR INFORMATION,
see Page 23

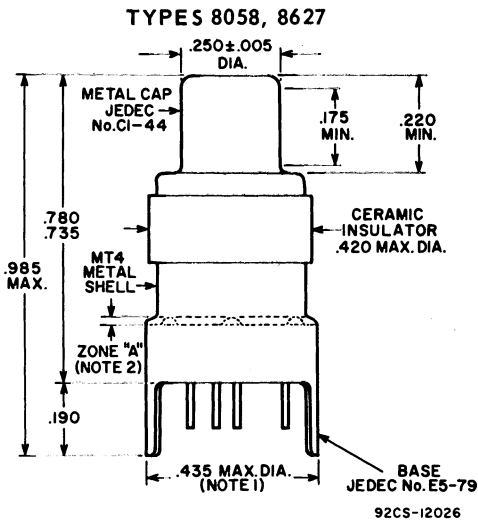

JEDEC No. 4-6

DIMENSIONAL OUTLINES
Dimensions in Inches

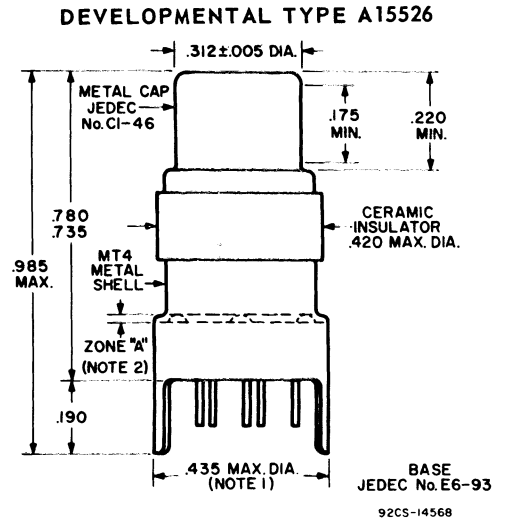

Note 1: Maximum O.D. of 0.440" is permitted along 0.190" lug length.

Note 2: Envelope temperature should be measured in Zone "A".

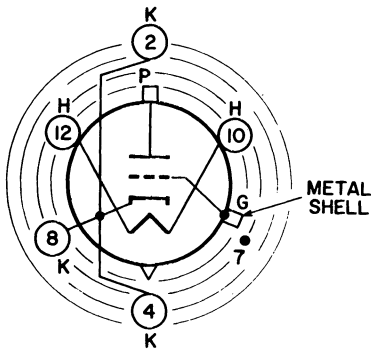

INDEX = LARGE LUG
● = SHORT PIN-IC

JEDEC 12CT

- Pin 2 - Cathode
- Pin 4 - Cathode
- Pin 7* - Do Not Use
- Pin 8 - Cathode
- Pin 10 - Heater
- Pin 12 - Heater
- Metal Shell - Grid
- Top Cap - Plate

TERMINAL DIAGRAMS
Bottom View

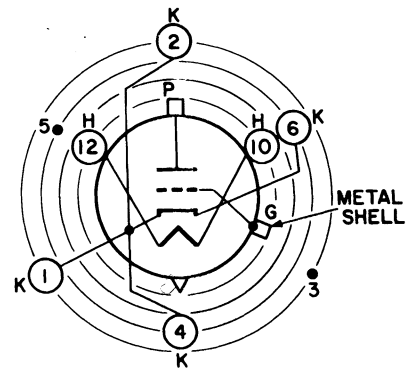

INDEX = LARGE LUG
● = SHORT PIN-IC

- Pin 1 - Cathode
- Pin 2 - Cathode
- Pin 3* - Do Not Use
- Pin 4 - Cathode
- Pin 5* - Do Not Use
- Pin 6 - Cathode
- Pin 10 - Heater
- Pin 12 - Heater
- Metal Shell - Grid
- Top Cap - Plate

* Pin is of a length such that its end does not touch the socket insertion plane.

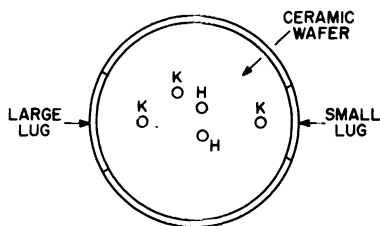

92CS-13211

MODIFIED BOTTOM VIEWS
With Element Connections Indicated
and Short Pins Not Shown

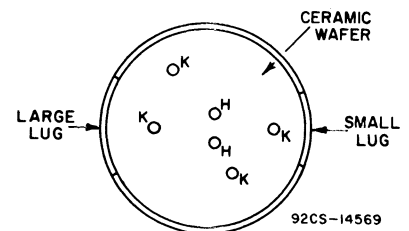

92CS-14569

NOTES

RCA FIELD SALES OFFICES

EQUIPMENT

DISTRIBUTOR

CALIFORNIA

6363 Sunset Blvd., Hollywood, Calif., 90028 (213) 461-9171
 4546 El Camino Real, Los Altos, Calif., 94022 (415) 948-8996
 7969 Engineer Rd., Suite 216, San Diego, Calif. 92111 (714) 279-0420

DISTRICT OF COLUMBIA

1725 "K" St., N.W., Washington, D.C. 20006 (202) 337-8500

FLORIDA

2828 Broadway, Riviera Beach, Fla. 33404 (305) 842-1577

ILLINOIS

446 E. Howard Ave., Des Plaines, Ill. 60018 (312) 827-0033

INDIANA

2511 East 46th St., Building Q2, Atkinson Sq. Indianapolis, Ind. 46205 (317) 546-4001

MASSACHUSETTS

64 "A" St., Needham Heights, Mass. 02194 (617) 444-7200

MICHIGAN

28840 Southfield Rd., Lathrup Village, Mich. 48075 (313) 353-9770

MINNESOTA

5805 Excelsior Blvd., Minneapolis, Minn. 55416 (612) 929-0676

MISSOURI

7711 State Line, Suite 112, Kansas City, Mo. 64114 (816) 363-1720

NEW JERSEY

(Metropolitan Phila.):
 605 Marlton Pike, Haddonfield, N.J. 08034 (609) 428-4802
 (Metropolitan NYC):
 2075 Millburn Ave., Maplewood, N.J. 07040 (201) 485-3900

NEW YORK

731 James St., Room 206, Syracuse, N.Y. 13203 (315) 474-5591

OHIO

1621 Euclid Ave., 1600 Keith Bldg., Cleveland, Ohio 44115 (216) 579-0880

TEXAS

210-C Court Terrace, Exchange Park North, Dallas, Texas 75235 (214) 351-5361

CALIFORNIA

6363 Sunset Blvd., Hollywood, Calif. 90028 (213) 461-9171
 343 Sansome Street, 7th Floor San Francisco, Calif. 94104 (415) 956-4818

COLORADO

RCA-2785 No. Speer Blvd., Room 223, Denver, Colorado 80211 (303) 433-0432

DISTRICT OF COLUMBIA

1725 "K" St., N.W., Washington, D.C. 20006 (202) 337-8500

FLORIDA

2828 Broadway, Riviera Beach, Florida 33404 (305) 842-2171

GEORGIA

RCA Bldg., 14 Executive Park Drive, N.E. Atlanta, Georgia 30329 (404) 634-6131

ILLINOIS

446 E. Howard Ave., Des Plaines, Illinois 60018 (312) 827-0033

INDIANA

RCA-501 No. LaSalle St., Indianapolis, Indiana 46201 (317) 636-5321

MASSACHUSETTS

80 "A" St., Needham Heights, Mass. 02194 (617) 444-8492

MICHIGAN

28840 Southfield Road, Lathrup Village, Michigan 48075 (313) 353-9770

MINNESOTA

5805 Excelsior Blvd., Minneapolis, Minn. 55416 (612) 929-0676

MISSOURI

7711 State Line, Suite 112, Kansas City, Mo. 64114 (816) 363-6462

NEW YORK

36 W. 49th St., New York, N.Y. 10020 (212) 689-7200
 731 James St., Room 206, Syracuse, N.Y. 13203 (315) 479-8134

OHIO

1621 Euclid Ave., 1600 Keith Bldg., Cleveland, Ohio 44115 (216) 579-0880

TEXAS

210-C Court Terrace, Exchange Park North, Dallas, Texas 75235 (214) 351-5361

WASHINGTON

2246 First Avenue S., Seattle, Washington 98134 (206) 622-8350

GOVERNMENT

INTERNATIONAL

CALIFORNIA

6363 Sunset Blvd., Hollywood, Calif., 90028 (213) 461-9171

DISTRICT OF COLUMBIA

1725 "K" St., N.W., Washington, D.C. 20006 (202) 337-8500

NEW JERSEY

2075 Millburn Ave., Maplewood, N.J. 07040 (201) 485-3900

U.S.A.

Central & Terminal Aves., Clark, N.J. 07066 (201) 382-1000
 Cable: RADIOINTER

CANADA

1001 Lenoir Street, Montreal 30, Quebec (514) 933-7551
 Cable: VICTORADIO

EUROPE

118 Rue du Rhone, Geneva, Switzerland 35 75 00 to 09
 Cable: RADIOCORP

FAR EAST

415 Prince's Building, Chater Road Hong Kong 239529 239522
 Cable: RADIOINTER

RCA TECHNICAL PUBLICATIONS



**ELECTRON TUBE
HANDBOOK HB-3**

**RCA RECEIVING TUBE
MANUAL RC-25**

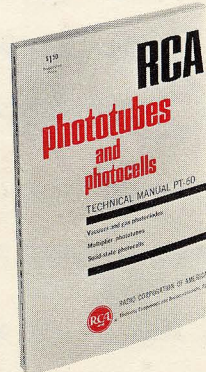
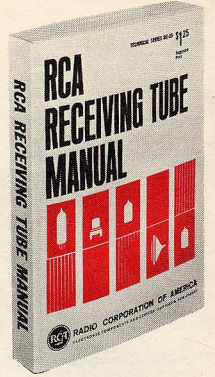

**RCA PHOTOTUBE
MANUAL PT-60**

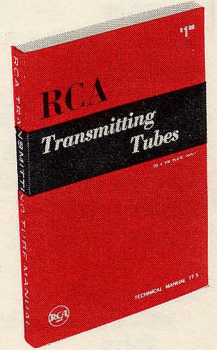

**RCA TRANSMITTING
TUBE MANUAL TT-5**

RCA INDUSTRIAL AND MILITARY NUUVISTORS ARE AVAILABLE
FROM YOUR



INDUSTRIAL TUBE DISTRIBUTOR