

~ p 20
~ p 22 v 6

COUNTER TUBE AND SELECTOR TUBE

CONSTRUCTION

The Philips counter tube and selector tube consist of 30 identical rod-shaped cathodes arranged in a circle concentric with the common circular plate anode (see Fig.1). The 30 cathodes are divided into three groups of ten and arranged so that every third electrode going around the ring belongs to the same group. The three groups are called main cathodes, guide A cathodes, and guide B cathodes. The order of the electrodes proceeding in a clockwise direction around the tube as seen from the dome is a main cathode, a guide A cathode, guide B cathode, next main cathode etc.

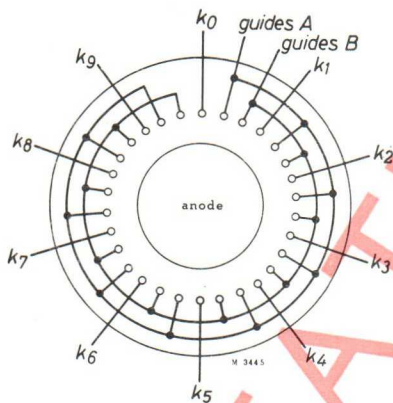

Fig.1. Electrode configuration of the Z 303 C and the Z 502 S.

In both the counter tube and the selector tube all the guide A electrodes are connected internally and brought out to a single pin. The guide B electrodes are similarly connected and brought out. In the counter tube the main cathodes k_1 to k_9 are connected together internally and connected to a single pin. The 0 or tenth main cathode k_0 is brought out separately so that the tube can be set to zero and also an electrical output obtained for driving a succeeding tube. In the selector tube all the main cathodes are brought out individually so that an electrical output pulse can be obtained at any point around the tube.

FUNCTION OF THE ELECTRODE GROUPS

1. MAIN CATHODES

The glow normally rests on a main cathode thus providing indication, and electrical output may also be obtained from this cathode. The position of the discharge may be seen through the dome of the tube as an orange 'cathode glow' at the tip of the cathode concerned. The position of the discharge can be related to the number of input pulses by the use of an external numbered escutcheon aligned so that the numbers coincide with the position of the main cathodes.

2. GUIDE CATHODES (A and B)

The function of the guide cathodes is to transfer the discharge from one main cathode to the next on the receipt of an input signal.

Basic circuit

The basic circuit is shown in Fig.2 and is essentially the same for both the counter and the selector tube. A supply voltage, normally 475 V, (which is greater than the anode-cathode ignition voltage) is applied to the circuit, and breakdown to one of the main cathodes will, therefore, occur. Breakdown to more than one cathode cannot occur since conduction causes a voltage drop across the anode resistor and reduces the anode voltage across the tube to the maintaining voltage.

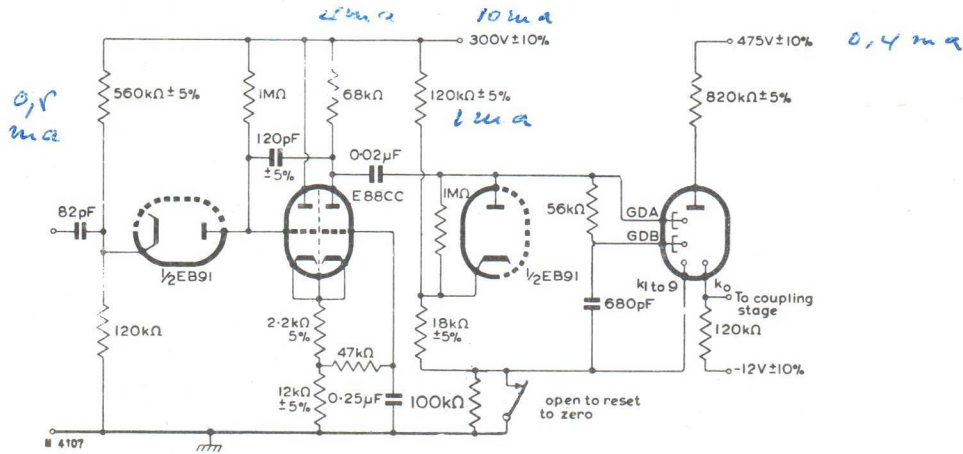

Fig.2. Integrated pulse drive circuit. The amplitude of the input pulse should be at least 30 V, the rise time dV/dt at least 10^8 V/sec. All components are $\pm 10\%$ unless otherwise stated. Instead of the E 88 CC the ECC 81 may also normally be used.

THE TRANSFER MECHANISM

The method usually employed to move the discharge around the tube is to convert the input signal into a pair of negative pulses. The first pulse is applied to all guide A cathodes followed immediately by the second pulse applied to all guide B cathodes.

Assume that the discharge is resting on the third main cathode k_3 ; when the pulse is applied to guides A the voltage between anode and guides A exceeds the ignition voltage and breakdown can therefore occur. Because of the priming from the discharge to the conducting main cathode k_3 breakdown will always occur to the adjacent guide A cathode (guide A_4). The discharge to k_3 will be extinguished since the anode voltage falls by the magnitude of the applied negative pulse. Similarly breakdown to guide B_4 will take place on the arrival of the second pulse and the potential of guides A will return to the bias level. Finally at the end of the second pulse the potential of guides B will also return to the bias level. The anode voltage rises towards a potential equal to the guide bias plus the maintaining voltage. However, when the anode-to- k_4 voltage exceeds the ignition value the discharge will move to k_4 and the transfer has then been completed. This sequence results in rotation in the clockwise direction. Counting in the anti-clockwise

direction can be obtained by applying pulses to guides A and B in the reverse order.

OUTPUT PULSE

A resistor is connected in series with k_o (in Fig.2) so that an output pulse can be obtained when the discharge rests on k_o . This resistor must be chosen so that when the glow rests on k_o , the voltage on k_o does not exceed the positive guide bias. It is common practice to take the earthy end of the resistor back to a negative bias supply to obtain a larger pulse. However, the magnitude of the bias should not at any time be more negative than -20 V.

In the selector tube an output can be obtained by inserting a resistor in series with any of the main cathodes.

The maximum value of the main cathode resistor for either selector or counter is given by

$$R_k \text{ max.} = \frac{(V_G + V_{k_o} - 10)R_a}{(V_b - V_M - V_G + 10)}$$

and the output voltage for any value of R_k is

$$V_{out} = \frac{(V_b - V_M + V_{k_o})R_k}{(R_k + R_a)}$$

where V_b is the supply voltage
 V_M is the maintaining voltage
 V_G is the positive guide bias
 V_{k_o} is bias to k_o (numerical value only)
 R_k is the cathode resistor
 R_a is the anode resistor

SET ZERO

The discharge can conveniently be returned to k_o by momentarily disconnecting all cathodes except k_o . An alternative method is to pulse k_o negatively to -120 V. Care must be taken if this method is adopted that spurious pulses are not fed down the chain of counter tubes at the termination of the pulse.

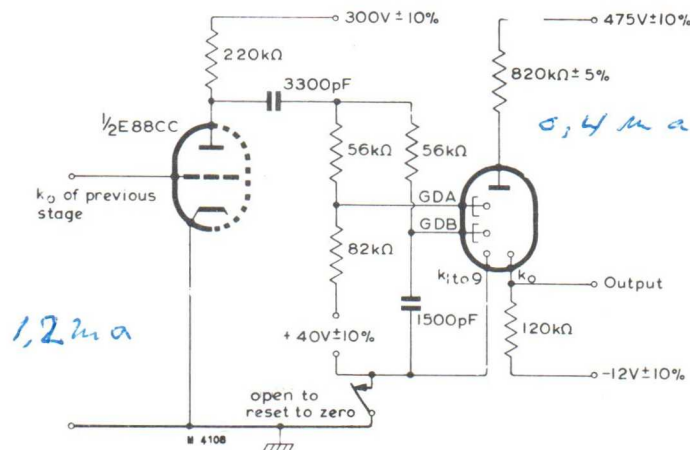

Fig.3. Integrated pulse coupling circuit. All components are $\pm 10\%$ unless otherwise stated. Instead of the E 88 CC the ECC 81 may also normally be used.

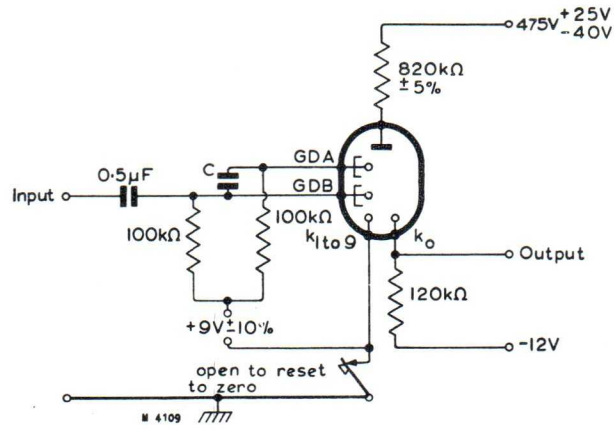

Fig.4. Circuit for sine wave drive. All components are $\pm 10\%$ unless otherwise stated.

Frequency (c/s)	50	100	200	500	1000	2000	4000
Capacitor C (μF)	0.1	0.05	0.02	0.01	0.005	0.002	0.00068

Z 303 C

COLD-CATHODE BI-DIRECTIONAL DECADE COUNTER TUBE

The Z 303 C is a cold-cathode gas-filled bi-directional decade counter tube. This tube has ten main cathodes, nine of which are brought out together and one separately. It gives visual indication and operates at speeds up to 4 kc/s.

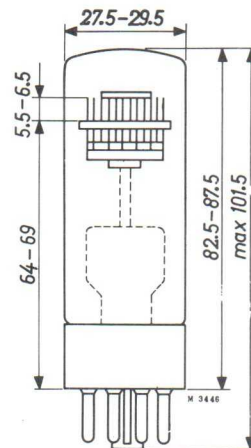
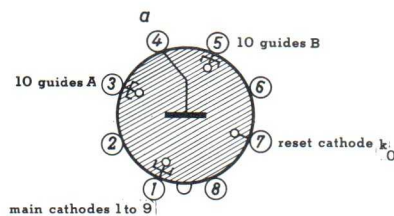
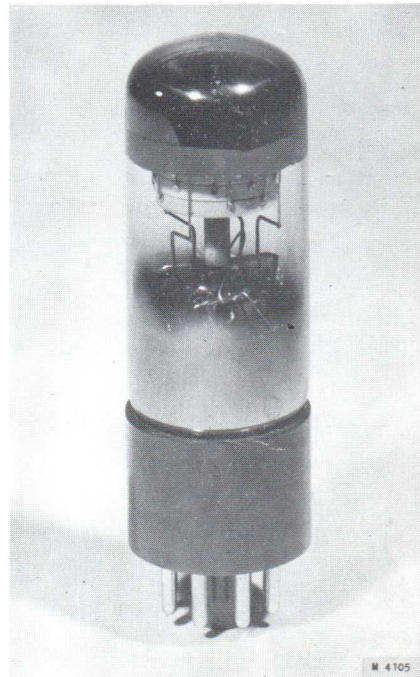

Fig.5. Electrode connections and dimensions (in mm) of the Z 303 C. Tube base: Octal. Main cathode k_0 is aligned with pin 6 to within $\pm 12^\circ$.

CHARACTERISTICS

Maximum counting rate (sine or pulse drive)	4.0	kc/s
Minimum time difference between two successive input signals	250	μ s
Maintaining voltage at $I_k = 300 \mu$ A	186 to 196	V
Minimum pulse required for forced resetting to k_c	120	V

RECOMMENDED OPERATING CONDITIONS

Supply voltage	475	V
Bias voltage on k_0	-12	V
Anode load	820	$k\Omega$
Output cathode load	120	$k\Omega$
Anode current	340	μA
Resultant output pulse	35	V
<i>For double pulse drive</i>		
Guide bias	+40	V
Pulse amplitude	100	V
Pulse width	75	μs
<i>For integrated pulse drive (see Fig.2. and 3)</i>		
Guide bias	+40	V
Pulse amplitude	See Fig. 2	
Pulse width	75	μs
<i>For sine wave drive (see Fig.4)</i>		
Guide bias	+10	V
Sine wave drive voltage (r.m.s.)	40 to 70	V

LIMITING VALUES (absolute ratings)

Minimum supply voltage	350	V*
Maximum voltage between any two electrodes (except anode)	140	V
Minimum positive guide bias for pulse drive and integrated pulse drive at 4 kc/s	+35	V**
Maximum k_0 negative bias	-20	V
Minimum guide pulse width	65	μs
Main and guide cathode current	{ max. 550 min. 250	μA

*) This limit applies in light and darkness.

***) At lower frequencies a lower value of positive bias can be used down to an absolute minimum of +18 V.

Z 502 S

COLD-CATHODE BI-DIRECTIONAL DECADE SELECTOR TUBE

The Z 502 S is a cold-cathode gas-filled bi-directional decade selector tube. This tube has ten main cathodes all of which are brought out separately. It gives visual indication and operates at speeds up to 4 kc/s.

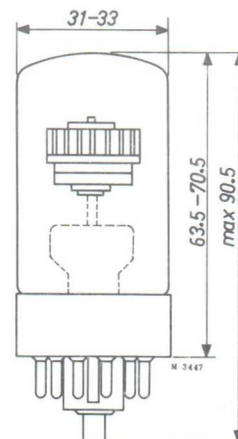
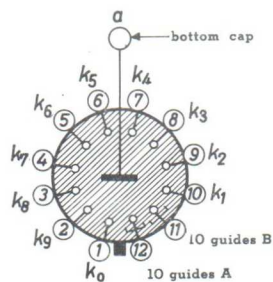

Fig.6. Electrode connections and dimensions (in mm) of the Z 502 S. Tube base: Duodecal 12-p. Main cathode k_1 is aligned with pin 11 to within $\pm 12^\circ$.

CHARACTERISTICS

Maximum counting rate (sine or pulse drive)	4.0 kc/s
Minimum time difference between two successive input signals	250 μ s
Maintaining voltage at $I_k = 300 \mu$ A	186 to 196 V
Minimum pulse required for forced resetting to any main cathode	120 V

RECOMMENDED OPERATING CONDITIONS

Supply voltage	475 V
Bias voltage on k_0	-12 V
Anode load	820 $k\Omega$
Output cathode load	120 $k\Omega$
Anode current	340 μA
Resultant output pulse	35 V
<i>For double pulse drive</i>	
Guide bias	+40 V
Pulse amplitude	100 V
Pulse width	75 μs
<i>For integrated pulse drive (see Fig.2 and 3)</i>	
Guide bias	+40 V
Pulse amplitude	See Fig. 2
Pulse width	75 μs
<i>For sine wave drive (see Fig.4)</i>	
Guide bias	+10 V
Sine wave drive voltage (r.m.s.)	40 to 70 V

LIMITING VALUES (absolute ratings)

Minimum supply voltage	350 V *)
Maximum voltage between any two electrodes (except anode)	140 V
Minimum positive guide bias for pulse drive and integrated pulse drive at 4 kc/s	+35 V**)
Maximum negative bias to any main cathode	-20 V
Minimum guide pulse width	65 μs
Main and guide cathode current	} max. 550 μA } min. 250 μA

*) This limit applies in light and darkness.

***) At lower frequencies a lower value of positive bias can be used down to an absolute value of 18 V.