

RADIOTRONICS

Volume 17

January 1952

No. 1

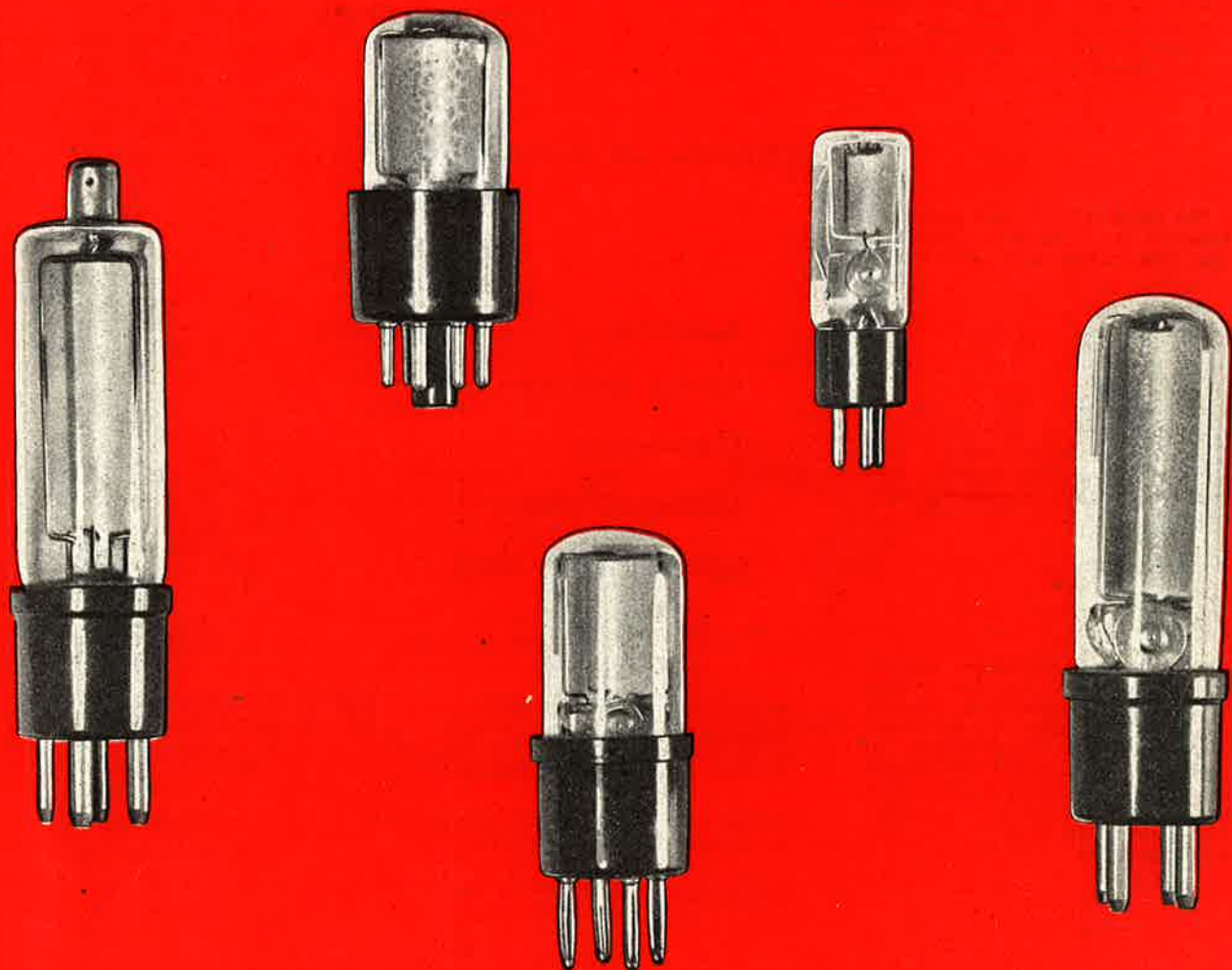

An  Publication

PRICE
1/6

Registered at the General Post Office Sydney for transmission by post as a periodical.

RADIOTRONICS

Volume 17

January 1952

Number 1

By the way—

No one likes having his name or address misspelt on his mail. If there is anything wrong with the address on your Radiotronics envelope, please make the correction, cut out and return the address stencil to us. Thank you.

The following 1951 back issues are available at 1/- per copy:—January plus July to December inclusive.

The February issue will be largely devoted to audio frequency articles; the feature being a description of a high quality L.P. amplifier and its associated components.

The article on phototubes appearing in this issue has been taken from an RCA publication entitled "Phototubes Booklet" by the courtesy of Radio Corporation of America. The outlines and graphs were abstracted from another RCA publication, "Phototubes, Cathode-Ray and Special Types" with acknowledgements.

Information concerning new RCA releases published in Radiotronics is intended for information only, and present or future Australian availability is not implied.

Editor:
Ian C. Hansen,
Member I.R.E. (U.S.A.).

Asst. Editor:
R. Ainsworth, A.S.T.C.,
A.M.I.R.E. (Aust.).

CONTENTS

	Page
Phototubes and their applications—	
Introduction	3
Installation	6
Application	7
Spectral Sensitivity curves	15
Characteristics	16
Dimensional outlines	18
Interchangeability chart	20

Radiotronics is published twelve times a year by The Wireless Press for Amalgamated Wireless Valve Company Pty. Ltd. The annual subscription rate in Australasia is 10/-; in U.S.A. and dollar countries \$1.25; and in all other countries 11/-. Price of a single copy 1/-.

Original articles in Radiotronics may be published without restrictions provided that due acknowledgment is given.

Address all communications as follows:—

Amalgamated Wireless Valve Co. Pty. Ltd.,
Technical Publications Department,
G.P.O. Box 2516,
Sydney.

Phototubes and Their Applications

Introduction

A phototube consists principally of two electrodes in an evacuated glass envelope. One electrode, the cathode, emits electrons when its sensitized surface is exposed to light or other radiant energy. These electrons are drawn to the second electrode, the anode, because this electrode is operated at a positive potential. The number of electrons emitted by the cathode depends on the wave length and the amount of radiant energy falling on it. The phototube thus provides an electric current whose magnitude can be controlled by light or other radiant energy.

Radiotron phototubes fall into two main groups — gas and high vacuum. Most of the gas types are designed primarily for sound reproduction, but their high sensitivity makes these types also suitable for many relay applications.

The most commonly used phototube in the 35 mm. sound field is the 868. Similar, but with slightly higher sensitivity is the 918. Where a smaller octal-based equivalent is needed, the 930 is available. This supersedes the obsolete 923. The 1P40 is identical to the 930, but has a low-loss base for applications where leakage is critical. For push-pull reproduction, the 920 is used.

For dye-image sound track reproduction, a range of phototubes generally similar to those mentioned above, is manufactured. These are as follows, with their companion types in brackets. 1P37 (868, 918), 5581 (930), 5583 (927), 5584 (920).

Relay applications are provided for with the above types together with the following specialised ones. End-on 1P41, replacing the obsolete 924: 921 and 5582, cartridge types differing only in response: 928, non-directional type.

The 1P29 is the last in the gas filled group and is designed for colourmetric work.

The high-vacuum group is of primary interest to the designer of light-operated relays and light-measuring equipment. Tubes in this group are made with four different kinds of surfaces. Amongst these four surfaces, the S3 surface used in the 926 has the spectral response closest to that of the eye. This tube is, therefore, of particular interest in colourmetric work. For light measurement mainly, but also useable for relay work, are the 1P39 with low-loss base and its companion type 929. These tubes with S4 response are responsive to blue and blue-green radiation. Types 917 and 919 with S1 response have low leakage construction, the difference between them

being that the former has top-cap anode, the latter a top-cap cathode connection.

For use in the ultra-violet region, the 935 with an S5 response is the most suitable.

Where small size and end-on working is required, the 1P42 can be used to good advantage, while for normal relay work the 922 cartridge type and 925 short-bulb octal-based type are available. These latter have their maximum response in the red and infra-red region and are therefore useful with filter for alarm systems.

PHOTOTUBE
CLASSIFICATION CHART

Response	S-1	S-3	S-4	S-5	S-8	S-9
SINGLE-UNIT PHOTOTUBES						
Vacuum Types	917 [⊙] 919 [⊙] 922 [⊙] 925 [⊙]	926 [⊙]	1P39 [⊙] 1P42 [⊙] 929 934 5653	935		
Gas Types	1P40 [⊙] 1P41 [⊙] 868 918 921 [⊙] 927 928 [*] 930	1P29	1P37 5581 5582 [⊙] 5583			
TWIN PHOTOTUBES						
Vacuum Types			5652 [⊙]			
Gas Types	920 [⊙]		5584 [⊙]			
MULTIPLIER PHOTOTUBES						
Vacuum Types			1P21 [†] 931-A	1P28	1P22	5819 [⊙]

- End type for head-on operation.
- Low-leakage type with anode-terminal cap.
- ▲ Short type.
- Twin type having two composite anode-cathodes.
- Twin type having two separate cathodes and two separate anodes.
- † For applications involving very low light levels.
- ⊙ For applications critical as to leakage under high-humidity conditions.
- ⊙ For applications involving large-area light sources.
- Low-leakage type with cathode-terminal cap.
- Cartridge type.
- * Non-directional.

For facsimile and 16 mm. sound work the 934, a companion to the gas-filled 927, serves the purpose satisfactorily. The 5652 is a special type having two composite anode-cathodes and is intended for facsimile work. For relay applications where a higher dark current than the 929 is permissible, the 5653, which has a similar response to the blue region, is available in an octal base.

Multiplier phototubes form a special section of the high-vacuum group. For general applications the 931-A is employed, but where much higher sensitivity is required, the 1P21 which has the same response, is available. The 1P22 has a response similar to that

of the human eye, while the 1P28 responds to ultra-violet radiation. For specialised applications, such as in scintillation counters, the 5819 has been developed. This type is also used where low level, large area light sources are encountered.

Additional information on the choice of a phototube type for a specific relay or measurement circuit is given under "Application".

Sensitivity of phototubes

The sensitivity of a phototube is basically defined as the quotient of the current through the valve by the radiant flux received by the cathode. When sensitivity is stated in accordance with this basic definition, it is usually given in terms of microamperes per microwatt of radiant flux. The term "radiant flux" includes both visible radiation, or light, and invisible infra-red and ultra-violet radiation. For convenience, sensitivity is frequently stated in terms of visible radiation only. When it is given in this way it is known as "luminous sensitivity" and is usually given in terms of microamperes per lumen of light flux.

The sensitivity of a phototube depends on the colour of the light or the spectral distribution of the radiant flux used to excite the valve. For example, the 929 phototube has much higher sensitivity to blue-rich light, such as light from a mercury-vapor lamp, than to blue-deficient light, such as the light of an incandescent lamp. It follows that, when two phototube types are compared on the basis of their sensitivity ratings, the comparison will be valid only if the rated values have been measured with radiations of the same spectral distribution. Also, when two phototube types are being considered for use with a certain light source, if the two types have different colour-response curves, a comparison of the sensitivity rating of one type with that of the other may be misleading unless both ratings are for light similar in colour to that which is to be used. The sensitivity of Radiotron phototubes is measured with radiation provided by a tungsten lamp operated at a filament colour temperature of 2870° Kelvin. Exciter lamps used in sound-on-film equipment are generally operated at approximately this temperature.

Gas and high-vacuum types

The presence of a small amount of inert gas in a phototube increases the tube's sensitivity, or in other words, the gas increases the amount of current passed by the phototube for a given amount of cathode illumination. Therefore, in the manufacture of several phototube types, a controlled amount of gas is introduced in the tube after evacuation. These gas types have higher sensitivity than the corresponding vacuum types and are generally preferred for some applications, principally those involving sound reproduction. High-vacuum types, on the other hand, have higher internal resistance, more constant sensitivity throughout life, and are less likely to be damaged by accidental operation at higher-than-rated voltage or current. The high-vacuum types are, therefore, preferable for many light-operated relay and light-measurement applications.

The action of gas in increasing the sensitivity of

a phototube is briefly as follows: Electrons moving from cathode to anode collide with gas atoms. In such a collision, the electron may disrupt the atom, knocking an electron out of the atom and leaving a positive ion. This disruption of the atom increases the current through the valve because the new electron is drawn to the anode and the positive ion is drawn to the cathode. The positive ion can further increase current, when it arrives at the cathode, by causing secondary emission from the cathode. Therefore, the presence of gas in the valve increases current in two ways, (1) by the production of ions, and (2) by the increase in cathode emission. The total current in a gas phototube can be several times that of a corresponding high-vacuum type operated with the same light input and anode voltage.

SPECTRAL CHARACTERISTIC OF HUMAN EYE & OF TUNGSTEN LAMP AT COLOR TEMPERATURE OF 2870°K

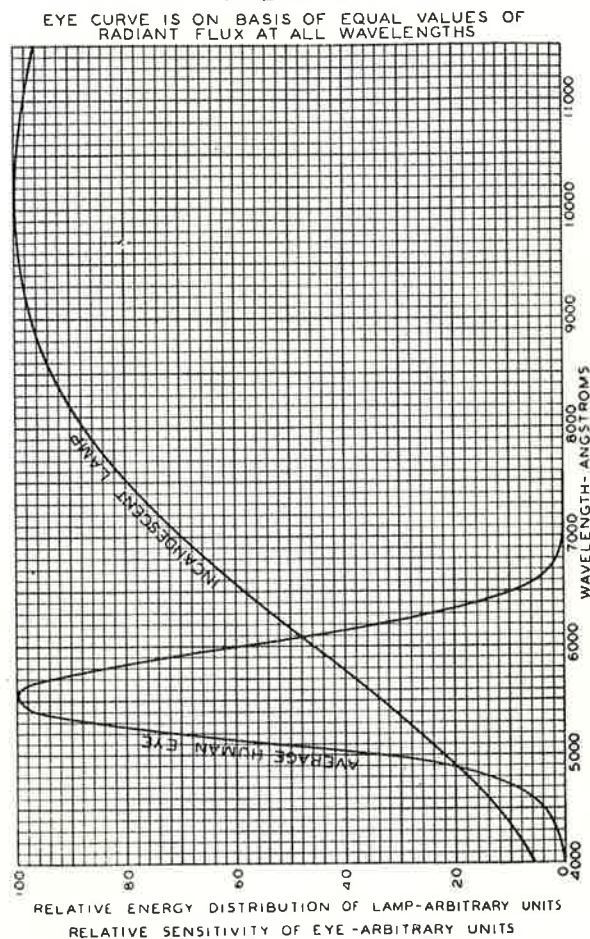

Static and dynamic sensitivities of gas types

When a phototube is used under steady illumination, its luminous sensitivity can be defined as the quotient of the direct anode current by the incident light flux of constant value. This sensitivity is called the "static luminous sensitivity."

When the phototube is used for sound reproduction, the light input to the phototube varies at audio frequency. For this operating condition, the luminous sensitivity of the valve is conveniently defined as the

quotient of the amplitude of variation in phototube current by the amplitude of variation in light input. In a gas phototube, this sensitivity, identified as the "dynamic sensitivity," is smaller for a light input varying at high audio frequency than for low frequencies. The reason can be understood from the preceding explanation of how gas increases sensitivity. Because gas ions are relatively large and move relatively slowly, there is a time lag between the disruption of a gas atom and the increase in cathode emission due to the resultant positive ion. Because of this time lag, fluctuations in the emission due to positive ions lag behind fluctuations in the primary photoemission. For high frequencies of light variation, the lag tends to smooth out the variations in the total phototube current and thus, by definition, reduces sensitivity.

The effect is illustrated by the curve which shows how the sensitivity of Radiotron gas phototubes changes with the frequency of variation in light input. It can be seen that the decrease in sensitivity occurs only at high audio frequencies and that the decrease is small enough so that the tube can reproduce audio signals with good fidelity.

The range of luminous-sensitivity limits quoted for Radiotron phototubes is that which the tubes will display when operated under low-current conditions.

If a tube is to be operated under conditions approaching its maximum-current rating, the equipment design should provide for a wider sensitivity range having a minimum value equal to one-half of that shown for low-current operation. The sensitivity of a phototube under such high-current conditions is dependent upon the tube type, as follows:

1. Single-unit and twin phototubes

(a) **Gas types:** For high-current operation, and particularly in applications in which the type is subjected to these higher values continuously, a drop in sensitivity below the values for low-current operation may be expected, the extent of the drop being affected by the severity of the operating conditions. After a period of idleness, a gas phototube usually recovers most of its initial sensitivity.

(b) **Vacuum types:** Unlike gas phototubes, this class of phototubes shows negligible drop in sensitivity values for different degrees of illumination and over long periods of use. The output current of a vacuum phototube is a linear function of the exciting illumination under normal operating conditions. The frequency response is flat up to frequencies at which transit-time effects become the limiting factor.

2. Multiplier phototubes

Although Radiotron Multiplier Phototubes are vacuum types, a drop in sensitivity is to be expected from this class of phototubes when operated at high anode-current values. The extent of the drop is affected by the nature and severity of the operating conditions to which the tube is subjected. After a period of idleness, the multiplier phototube usually recovers a substantial percentage of this loss of sensitivity.

Multiplier-phototube-sensitivity values are dependent on the respective amplification of each dynode

stage. Hence, large variations in sensitivity can be expected between individual tubes of a given type. The overall amplification of a multiplier phototube is equal to the average amplification per stage raised to the n th power, where n is the number of stages. Thus, very small variations in amplification per stage produce very large changes in overall tube amplification.

Because these overall changes are very large, it is advisable for designers to provide adequate adjustment of the supply voltage per stage so as to be able to adjust the amplification of individual tubes to the desired design value. It is suggested that an

FREQUENCY-RESPONSE CHARACTERISTICS OF GAS PHOTOTUBES

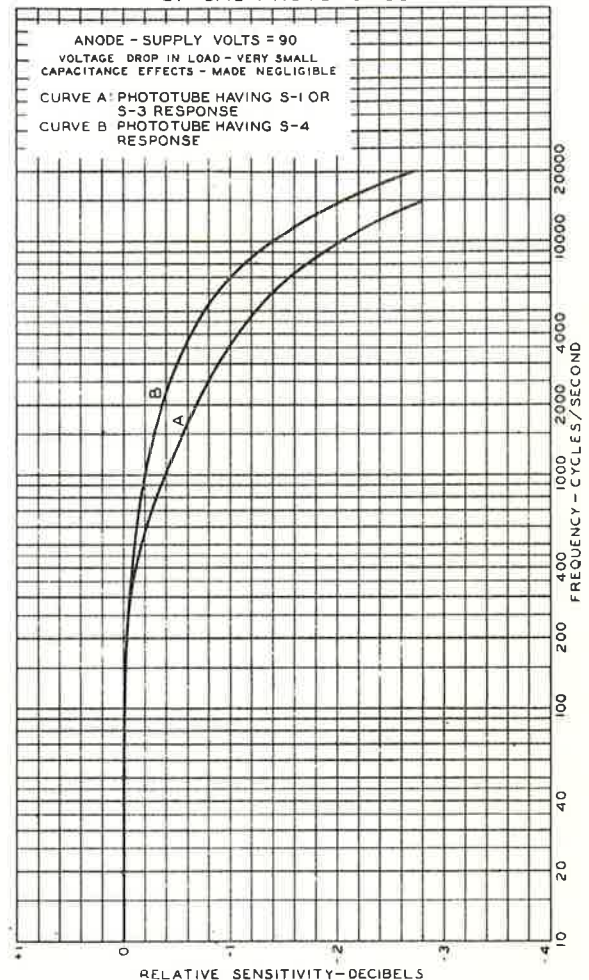

overall voltage-adjustment range of at least 2 to 1 be provided. When the output current can be controlled by change in the illumination of the photocathode of the multiplier phototube, the required range of adjustment in the voltage per stage can be reduced.

Sensitivity measurements

The luminous-sensitivity values quoted later are measured according to the following procedures:

1. Single-unit and twin phototubes

(a) **Gas types:** The light source consists of a tungsten lamp operating at a filament colour tem-

perature of 2870°K. For the 0-cycle measurements, a light input of 0.1 lumen is used, unless otherwise specified. For the 5,000-and 10,000 cycle measurements, the light input is varied sinusoidally about a mean value of 0.015 lumen from zero to a maximum of twice the mean. For all measurements, a d.c. anode-supply voltage of 90 volts and a 1.0-megohm load resistor are employed. Under these conditions, the effect of tube capacitance is negligible.

(b) **Vacuum types:** The light source consists of a tungsten lamp operating at a filament colour temperature of 2870°K. A steady light input of 0.1

lumen is used, unless otherwise specified, together with a d.c. anode-supply voltage of 250 volts and a 1-megohm load resistor.

2. Multiplier phototubes

The light source consists of a tungsten lamp operating at a filament colour temperature of 2870°K. A light flux of 10 microlumens from a rectangular aperture approximately 0.8" long and 0.2" wide is projected normal to the cathode in the direction noted on the basing diagram and outline. The load resistor has a value of 0.01 megohm. The applied voltages are specified on the individual data sheets.

Installation

General

Sockets for all types except the 928 should be mounted so that light is intercepted by the concave surface of the phototube's cathode. The socket for the 928 may be mounted in any suitable position since the cathode of this tube responds to light striking it from any direction.

Shielding of the phototube and its leads to the amplifier or relay tube is recommended when amplifier gain is high or when the phototube load resistance is high. In a circuit employing the 928, when the tube is operated with low impedance between cathode and ground, the cathode shields the anode from stray electrostatic fields. Whenever frequency response is important in a phototube circuit, the leads from the phototube to the amplifier or relay tube should be made short so as to minimize capacitance shunting of the phototube load. Since a phototube is a high-resistance device, it is important that insulation of associated circuit parts and wiring be adequate.

The **maximum ambient-temperature rating** of a phototube should not be exceeded because too high a bulb temperature may cause the volatile cathode surface to evaporate with consequent decrease in the life and sensitivity of the tube.

In **relay or measurement circuits** where the phototube must respond to a very small amount of light, phototube leakage currents should be made small. A low-resistance leakage path between the phototube terminals reduces the effective load resistance and thus decreases the circuit's sensitivity. Also, leakage currents may vary erratically and may mask the effect of the photoelectric current when this current is small. These leakage currents can be reduced by removing dust and grease from insulating surfaces between the phototube terminals with a cloth dampened in alcohol.

In the top-cap types 917, 919 and 935, and the cartridge types 921, 922, 926 and 5582, leakage across moisture films on the surface of the glass can be prevented by coating the glass with pure white ceresin wax, or other non-hygroscopic wax. The bulb should be first cleaned, then dipped in the molten wax and held there for a short time so that the heat of the wax will vaporize any moisture from the bulb surface. In the dipping operation the tem-

perature of the wax should not exceed 100°C, the maximum ambient-temperature rating for the phototubes listed above. It is not necessary to coat the whole bulb. A continuous band of wax, approximately a half-inch wide, around the top-cap or around the bulb is sufficient to interrupt all external leakage paths across the phototube surface.

When an amplifier valve is used in a circuit where extremely low leakage is important, the valve should preferably be a glass type having the grid brought out to a cap at the top of the valve; the bulb of such a valve can be waxed around the top-cap so as to minimize surface leakage. In a circuit employing one of the cartridge phototubes (921, 922, 926 or 5582), when low leakage is important, the phototube terminal which is connected to the amplifier grid-cap should not be in contact with a support that can cause leakage to ground.

Gas types

If the voltage or current ratings of a gas phototube are exceeded, a gas discharge may occur. This discharge is indicated by a faint blue glow within the tube. Once started, this discharge will continue independently of the illumination on the phototube. When a glow occurs, the anode supply voltage should be disconnected immediately in order to prevent permanent damage to the valve.

In most relay circuits, the phototube current exceeds 2 microamperes; in usual sound-on-film equipment, the phototube current is less than 2 microamperes.

When the anode-supply voltage for a gas phototube is obtained from an a.c. line without rectification, a voltage divider should be connected across the line so that the peak voltage supplied to the tube will never exceed 90 volts. For line voltages of 240 volts, the voltage divider should provide a phototube supply voltage of not more than one quarter the line voltage. In addition, a series protective resistor should be included in the phototube circuit.

Gas phototubes 868, 918, 921, 930, 1P40, 1P41 and 5582 give sensitive operation in relay circuits. However, these types are primarily designed for applications where the illumination on the phototube is low. These types can be used with large values of illumination but may lose sensitivity in such use.

Most of the loss takes place in the first few hours of high illumination with little loss thereafter. The loss can be made small by including in the circuit a large voltage-dropping resistance between the phototube and voltage supply. When a change in sensitivity of the above phototubes is not desirable, the light flux on the cathode should not exceed approximately 0.02 lumen.

Exposure to intense illumination, such as direct sunlight, may cause a temporary decrease in the sensitivity of a gas phototube even though no voltage is applied to the valve. The magnitude and duration of this decrease depend on the length of exposure.

In **sound-on-film equipment** employing gas phototubes, the amount of light passing through the slit and film to the phototube is usually so small that there is no danger of a rapid loss of phototube sensitivity so long as the tube is operated within ratings. When film is removed from the camera, the exciter lamp should be switched off so as to prevent excessive illumination of the phototube.

Vacuum types

For **constant calibration** of high-precision devices using a vacuum phototube, it is essential that the phototube be operated at an anode voltage of not more than about 20 volts. Higher anode voltages may cause ionization of minute traces of residual gas within the valve. The gas current resulting from this ionization may produce slow changes in the valve's characteristics which would change calibration. When a phototube is operated at low anode-supply voltage, the combination of large light input and high phototube load resistance is to be avoided. With this combination, the voltage drop across the load resistance may be so large that the voltage across the phototube is inadequate. In general, when the anode supply voltage is 20 volts, the d.c. voltage drop across the load resistance should not exceed 10 volts.

A further consideration for the maintenance of constant calibration is that the light incident on the phototube should be spread over as large a portion of the cathode surface as possible. This procedure will minimize variations in sensitivity that might be caused by a shift in the position of the light spot on the cathode.

Application

Circuits for sound reproduction

A typical phototube circuit for use in sound reproduction is shown in Fig. 1. The value of phototube load resistance for this circuit depends on the desired signal-output voltage and the permissible distortion. Increasing the phototube load resistance increases signal output but also increases distortion.

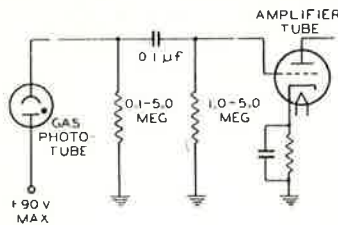

Fig. 1. Typical circuit for sound reproduction.

A typical circuit for the 920 twin phototube* is shown in Fig. 2. In this circuit, the contact on resistor R_2 should be set so as to balance out any difference which may exist between the sensitivities of the two units of the 920. Since the two units of the 920 are mounted in the same gas atmosphere, the ratio of sensitivities of the two units remains approximately constant throughout the life of the tube. Hence, once the circuit is balanced, the 920 tends to maintain balance.

* For description of push-pull system of sound reproduction for which 920 is designed, see "An Improved System for Noiseless Recording," G. L. Dimmick and H. Belar, Journal of the Society of Motion Picture Engineers, July, 1934.

Circuits for light-operated relays and light measurements

Choice of Phototube Type

Circuits for light-operated relays and for light measurements are shown in Figs. 3 to 13. The choice of a phototube type for one of these circuits depends on several factors including the important one of the colour of the light source. With respect to colour

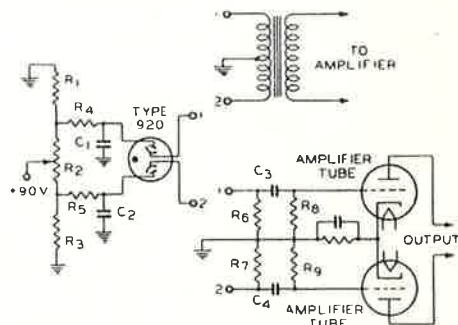

$R_1, R_2, R_3, R_4, R_5 = 0.5$ MEGOHM
 $R_6, R_7 = 0.1$ TO 5 MEGOHMS
 $R_8, R_9 = 1$ TO 5 MEGOHMS
 $C_1, C_2, C_3, C_4 = 0.1$ uF

Fig. 2. Typical circuit for twin phototube type 920 with either transformer or resistance coupling for sound reproduction.

sensitivity, Radiotron phototube types can be divided into three classes. In the first class are types having an S1 photo-surface. These types have high sensitivity in the red and infra-red region of the spectrum. Hence, circuits designed for high red sensitivity or for operation with infra-red radiation generally employ a phototube of this first class.

In the second class are the types 1P29 and 926, having an S3 photo-surface. The spectral sensitivity of this type extends throughout the visible spectrum and peaks in the blue. The relative response of this type to the light reflected from coloured objects approximates that of the eye. Hence, circuits used for colorimetry often employ the 1P29 and 926.

In the third class are the types having an S4 photo-surface. The sensitivity of these types is very high in the blue-violet and low in the red. For blue-rich light such as daylight or light from a carbon arc or mercury-vapour lamp, these give much higher sensitivity than other vacuum types. Although they have low red sensitivity, these types give better sensitivity than other vacuum types to light from an incandescent lamp operated at a filament colour temperature of 2870°K. When the filament of an incandescent lamp is operated at lower temperature, its reduced blue radiation will decrease the sensitivity of the S4 types.

When a phototube having an S1 surface is preferable, a choice can be made between gas and vacuum types. The presence of gas in a phototube increases the tube's sensitivity but decreases its internal resistance. As a result, in a circuit where it is impracticable to use a phototube load resistance higher than 10 megohms, a gas phototube may give more sensitive operation than a vacuum type; in a circuit where the phototube load resistance can be made larger than 10 megohms, a vacuum phototube may give more sensitive operation.

The sensitivity of a vacuum phototube is more nearly constant throughout valve life than that of a gas type. Also, a vacuum type is less likely to be damaged by accidental application of higher-than-rated anode voltage. Hence, in a circuit where the phototube load resistance can be made high, or where constant calibration or electrical ruggedness is important, a vacuum phototube should be used.

The Radiotron-2D21 gas tetrode in phototube circuits

The Radiotron-2D21 is a gas tetrode especially well suited for use in phototube circuits. The 2D21 is a relay valve; a small change in its grid potential can cause its plate current to change from zero to a comparatively large value. The value of grid potential at which plate current starts is called the critical value. Once plate current has started, its magnitude is determined by the anode supply voltage and the impedance in the anode circuit, and is practically independent of control-grid bias for all normal values of bias. In the conducting condition, the valve voltage drop is quite low and is substantially independent of the value of both anode current and control-grid bias.

Phototube relay circuits employing the 2D21 are shown in Figs. 3 and 4. In circuits like these, where the 2D21 is operated with an a.c. anode supply voltage, anode current in the 2D21 is zero during negative half-cycles of the a.c. voltage on the anode because, during these half-cycles, the anode is negative with respect to cathode. As long as the grid bias is less negative than the critical value, the valve will break down and conduct on positive half-cycles.

However, if the grid is made more negative than the critical value, it will prevent conduction on positive half-cycles. In other words, in a.c. operation, a change in grid potential can cause a 2D21 not only to close a relay but also to open it. This action is different from that obtained in d.c. operation where a change in grid potential can cause the 2D21 to close a relay, but normal changes in grid bias can not cause the relay to open. In d.c. operation, the only satisfactory methods for opening the relay, once closed, are to open the anode circuit, or to reduce the 2D21 anode supply voltage to a very low value.

One of the advantages of the 2D21 for use as a relay valve is its low anode-to-grid capacitance. This capacitance has been made low by inclusion of a shield-grid within the valve. Because this capacitance is low, the valve is insensitive to line-voltage surges. In order that this advantage can be utilized, circuit wiring should be laid out so as to introduce as little external capacitance as possible between the grid and anode.

Amplifier valves in relay and measurement circuits

In many relay and measurement circuits, it is desirable to use a phototube load resistance much higher than 10 megohms. When this resistance is connected between the grid and cathode of an amplifier valve designed for radio use, precautions are necessary because these valves, in general, are rated for operation with not more than 10 megohms d.c. resistance between grid and cathode. For power amplifier types, the maximum rated resistance generally is 0.5 megohm.

The reason amplifier valves have a maximum d.c. grid-circuit resistance rating is that gas current and grid emission can cause trouble if this resistance is too high. The diagram below illustrates how this trouble arises. *See also P.193.*

ARROWS INDICATE DIRECTION OF FLOW OF GRID-EMISSION CURRENT AND GAS CURRENT TO GRID

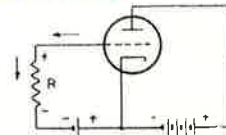

Gas current occurs because there is always a minute amount of residual gas in an amplifier valve. Atoms of this gas are ionized by collision with electrons flowing from cathode to anode. The resultant positive ions are drawn to the negative grid and flow to the source of negative bias voltage through the grid resistor R. The flow of these ions through R builds up a voltage drop across R which makes the grid less negative with respect to cathode. This decrease in negative grid bias increases plate current and thus causes an increase in gas ionization and in gas current to the grid. If the grid-circuit resistance is large enough, the action becomes cumulative and plate current may rise to a large value. Another effect that may contribute to the rise in plate current is emission of electrons from the grid. Positive gas ions bombarding the grid raise its temperature and may cause it to emit electrons. The flow of these electrons through R builds up a voltage drop across R which

reduces the negative grid bias. Thus, when the grid-circuit resistance is very large, gas current and grid emission may cause the plate current to vary erratically over a wide range or to rise to such a large value that the valve is damaged.

In phototube circuits where it is desired to operate an amplifier valve with a very large grid-circuit resistance, gas current can be reduced by operating the valve at low plate and screen voltages and low plate and screen currents. When the voltages across the valve and the currents through the valve are small, there is little gas ionization, and therefore little gas current. Grid emission can be reduced to a very low value by operating the heater at less than rated voltage so that the grid is at a reduced temperature.

From this discussion it can be understood why many relay and measuring circuits use two amplifier valves. The first valve employs a high grid-circuit resistance and is, therefore, operated at low plate current. The second valve usually has to supply enough current to operate a relay and, therefore, must have a comparatively small grid-circuit resistance. The first valve may, or may not, provide voltage amplification of the signal from the phototube. Its primary purpose usually is to act, not necessarily as a voltage amplifier, but as a "buffer" or "resistance transformer." That is, it must transfer the signal from the high-resistance load of the phototube to the comparatively low resistance in the grid circuit of the output valve.

In the circuits of Figs. 5, 6, 7, 8, 9, 10 and 12, the heater of the amplifier valve following the phototube is operated at approximately 4 volts instead of the normal value of 6.3 volts. Because of this large voltage reduction, it may be found that some individual amplifier valves do not give satisfactory operation in these circuits. Hence, these circuits are not well suited for use in equipment which is commercially manufactured and sold in large numbers of units. The relay circuits of Figs. 3 and 4 are well suited for use in such equipment. In Figs. 6, 10 and 12, the unused diode plates of the 6AV6 should be tied to the 6AV6 cathode.

In relay and measurement circuits where the output valve is a pentode or beam power valve, adjustments should be made prior to operation so that the plate current of the output valve will never become large enough to damage the valve or associated relay or meter. In general, the procedure is to set the screen voltage and grid bias of the output valve at zero volts and then increase the screen voltage until the plate current is at the maximum permissible value. The screen voltage is left at this value during use of the circuit. In most circuits, the grid can never become appreciably more positive than zero bias during normal operation; hence, the adjustment insures that, during normal operation, the plate current will not exceed the permissible value. When the adjustment is made, consideration should be given to the fact that, during use of the circuit, line voltage may swing higher than its value at the time the adjustment is made. Until the adjustment of screen voltage has been made, the screen voltage should be kept at a low value.

Circuit precaution

In the circuits of Figs. 3, 4, 5, 9, 10 and 12, circuits which are connected directly to the a.c. line, a double-pole on-off switch is shown. This switch makes it simple to disconnect the circuit from both sides of the line when repairs or adjustments are to be made and thus reduces the danger of shock.

Relay circuit, Fig. 3

A relay circuit in which the relay is energized by an increase in light is shown in Fig. 3. In this circuit, positive voltage is supplied to the 2D21 anode and the phototube anode during every other half-cycle of line voltage, when the upper side of the a.c. line is positive. During these half-cycles, negative bias voltage is supplied to the 2D21 grid from R_3 . The potential of the grid is made less negative by the IR drop across R_4 resulting from the flow of phototube current through R_4 . In the use of this circuit, the contact on R_3 is adjusted so that, as long as the illumination on the phototube is less than a certain value, the 2D21 grid potential is sufficiently negative to prevent conduction of plate current. When the illumination rises above this value, the IR drop across R_4 reduces the negative grid potential, the 2D21 conducts, and the relay closes. The resistance of R_3 is high enough to keep the current through the 2D21 within the valve's maximum rating.

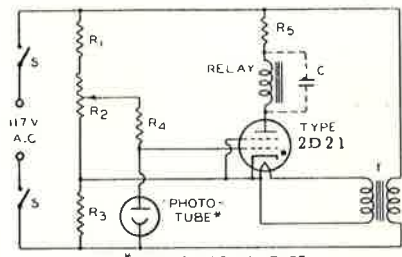

- C = 2-8 μ f, 250 V.; USED IF NEEDED TO PREVENT RELAY CHATTER
- R_1, R_2 { FOR VACUUM-TYPE PHOTOTUBE: $R_1 = 0$ OHMS, $R_2 = 5000$ OHMS, 4 WATTS
- { FOR GAS-TYPE PHOTOTUBE: $R_1 = 3000$ OHMS, 2 WATTS, $R_2 = 2000$ OHMS, 1 WATT
- $R_3 = 1000$ OHMS, 1 WATT
- $R_4 = 1-10$ MEGOHMS
- $R_5 =$ CURRENT-LIMITING RESISTOR, SEE TEXT
- S = DOUBLE-POLE ON-OFF SWITCH
- T = HEATER TRANSFORMER, 6.3 V., 0.6 AMP
- RELAY SHOULD OPERATE ON 25 MA. OR LESS

Fig. 4: Relay circuit employing type 2D21. Relay energised by *decrease* in light.

The function of R_5 in this circuit is to keep the relay current within the relay's maximum rating. To determine the proper value of this resistance, set the contact on R_3 so that the relay stays closed, and adjust R_5 to a value such that the relay current is within the relay's maximum rating. In many relays, the resistance of the relay supplemented by the resistance of R_3 is sufficient to hold the relay current to a safe value. With such a relay, R_5 can be omitted.

Relay circuit, Fig. 4

A relay circuit in which the relay is energized by a decrease in light is shown in Fig. 4. The operation of this circuit is similar to that of Fig. 3, the dif-

Figs. 3 & 4 were interposed. Scanned from March '53, P.38 / January, 1952

ference being that in Fig. 4, a decrease in phototube current makes the 2D21 grid less negative. The relay closes, therefore, whenever illumination drops below a certain value. This value can be controlled by adjustment of the contact on R_2 .

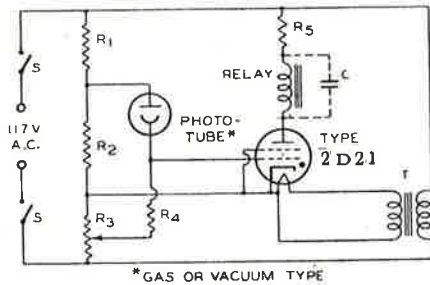

- C = 2-8 μ f, 250 V.; USED IF NEEDED TO PREVENT RELAY CHATTER
- FOR VACUUM-TYPE PHOTOTUBE: $R_1 = 0$ OHMS
 $R_2 = 20000$ OHMS, 1 WATT
- FOR GAS-TYPE PHOTOTUBE: $R_1 = 10000$ OHMS, 1/2 WATT
 $R_2 = 9000$ OHMS, 1/2 WATT
- $R_3 = 1000$ OHMS, 1 WATT
- $R_4 = 1-10$ MEGOHMS
- $R_n =$ CURRENT-LIMITING RESISTOR, SEE TEXT
- S = DOUBLE-POLE ON-OFF SWITCH
- T = HEATER TRANSFORMER, 6.3 V., 0.6 AMP.
- RELAY SHOULD OPERATE ON 25 MA. OR LESS

Fig. 3. Relay circuit employing type 2D21. Relay energised by decrease in light.

When a gas-type phototube is used in this circuit, the current through the 2D21 should be limited to a value such that the IR drop across R_3 cannot cause the peak voltage on the phototube to exceed 90 volts. Sufficient limitation is provided by making the total resistance of R_5 and the relay not less than 1,500 ohms. When the phototube is a vacuum type, the function of R_5 is the same as that of R_5 in Fig. 3.

Relay and measurement circuit, Fig. 5

A circuit which can provide faster response than the circuits of Fig. 3 and 4 is shown in Fig. 5. Because the circuits of Figs. 3 and 4 operate on a.c. without rectification, the relay in these circuits must be sluggish enough so that the 50-cycle variations in line voltage will not make the relay chatter. Also, the phototube in Figs. 3 and 4 is in operation only during alternate half-cycles of line voltage when the upper side of the a.c. line is positive. As a result, the circuits of Figs. 3 and 4 do not give good response to a change in light whose duration is on the order of one-sixtieth of a second or less. The circuit of Fig. 5, which includes a rectified d.c. power supply, can respond to changes shorter than a sixtieth of a second.

A further difference between the 2D21 circuits and the circuit of Fig. 5 is that the 2D21 plate current changes abruptly from one value to another when phototube illumination rises above a certain value. In Fig. 5, the 25L6-GT plate current changes continuously with change in phototube illumination. The circuit of Fig. 5 is, therefore, suitable for use not only as a relay circuit but also for illumination measurements.

When the phototube is connected as shown in solid lines in Fig. 5, an increase in phototube

illumination causes an increase in the plate current of the 25L6-GT. When the connections are as shown in dotted lines, an increase in illumination causes a decrease in output current.

When the circuit is to be connected as shown in solid lines, the procedure for adjusting it to give best operation is as follows: Set the contacts on R_3 and R_6 at the positive end of their ranges, and adjust the 25L6-GT screen voltage by means of R_7 so that the plate current of the 25L6-GT has the desired value of maximum output current. If the circuit is to operate a relay, this current should be slightly larger than the value which closes the relay. Next, move the contact on R_6 toward the negative end of R_6 until the IR drop across R_5 has the value such that the grid of the 25L6-GT is slightly negative with respect to the 25L6-GT cathode. The correct setting of R_n can be determined by measurement of the 25L6-GT plate current. When the movement of the contact on R_6 starts to affect this plate current, the 25L6-GT grid has a small negative bias, and R_6 is correctly adjusted. Next, set the phototube illumination at the value at which the relay is to close, or at the largest value to be measured, and move the contact on R_3 toward the negative end of R_3 until the movement of the contact starts to affect the plate current of the 25L6-GT. The circuit is then ready for operation.

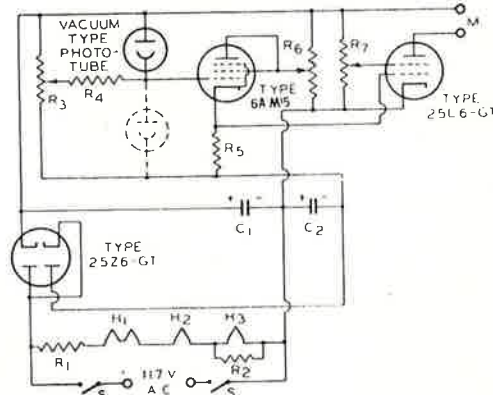

- $C_1, C_2 = 8 \mu$ f, 250 V.
- $H_1 = 25Z6$ -GT HEATER
- $H_2 = 25L6$ -GT HEATER
- $H_3 = 6AM5$ HEATER
- M = D-C MILLIAMMETER OR RELAY (0-25 MA.)
- $R_1 = 200$ OHMS, 20 WATTS
- $R_2 = 30$ OHMS, 1 WATT
- $R_3 = 1$ MEGOHM
- $R_4 = 100$ MEGOHMS
- $R_5 = 0.5$ MEGOHM
- $R_n, R_7 = 0.1$ MEGOHM
- S = DOUBLE-POLE ON-OFF SWITCH

Fig. 5. Fast-acting circuit for relay or measurement operations.

A small decrease in phototube illumination will produce comparatively large decrease in output current.

When the phototube is to be connected as shown in dotted lines, the adjustment procedure is the same except that during the adjustment of R_6 and R_3 , the phototube illumination should have the value at which the relay is to open or the smallest value to be measured. After the adjustments have been made, a small increase in illumination will produce a comparatively large decrease in output current.

In adjustment of the circuit with solid-line connections, if the phototube illumination during adjust-

ment of R_3 is large, it may be found that moving the contact on R_3 all the way to the negative end of R_3 does not affect the 25L6-GT plate current. This finding indicates that the sensitivity of the circuit is too high for the amount of light being used. The light on the phototube cathode should be reduced, or else the circuit sensitivity should be reduced by reducing the resistance of R_4 . Similarly, in adjustment of the circuit with dotted-line connections, if the phototube illumination used during adjustment of R_6 and R_3 is so large that the 25L6-GT plate current is much smaller than 25 milliamperes, the phototube illumination or the circuit sensitivity should be reduced.

Battery-operated relay and measurement circuit, Fig. 6

A battery-operated circuit for relay and measurement purposes is shown in Fig. 6. Because the current drawn from the 45-volt and 22½-volt batteries is low, the use of small batteries of the C-battery type of B_2 and B_3 will give long life. The 6AM5 requires a comparatively large plate current in order to operate a relay and is, therefore, supplied from a storage battery and vibrator-transformer. The vibrator and transformer can be of the type used in automobile radio receivers. Heater voltages can, of course, be obtained from the storage battery.

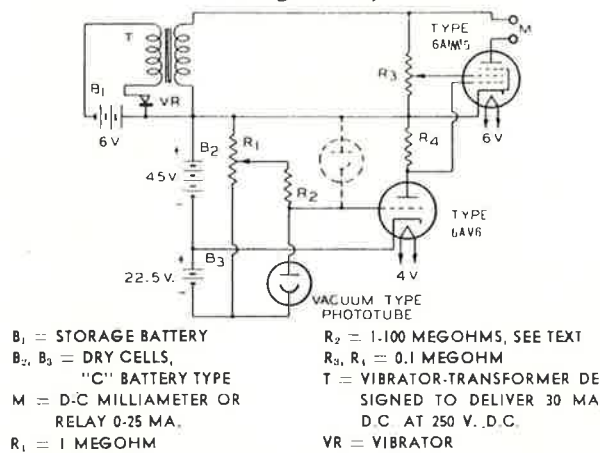

Fig. 6. Battery-operated circuit for relay or measurement operations.

When the phototube is connected as shown in solid lines, the plate current of the 6AM5 increases when phototube illumination increases. In the dotted-line connection, output current increases when illumination decreases.

A simple procedure for adjusting this circuit is as follows: Set the contact on R_3 at the lower end of R_3 and set the grid bias of the 6AM5 at zero by short-circuiting R_4 . Move the contact on R_3 until the plate current has the desired maximum value. The contact should never be moved so high that plate current exceeds 25 milliamperes; a plate current higher than 25 milliamperes may cause the maximum plate-dissipation rating of the 6AM5 to be exceeded. After R_3 is adjusted, the short-circuit connection across R_4 should be removed and R_1 should be adjusted so that the circuit gives best operation over

the range of illumination values to be encountered in use of the circuit.

If the maximum illumination of interest is very low, highest sensitivity will be obtained by use of a high value of resistance for R_2 . However, if the circuit is to respond to changes in a large value of illumination, it may be advisable to use a lower value for R_2 between 1 and 10 megohms. The reason is that the supply voltage for the phototube is low. If illumination is large and if R_2 is large, the voltage drop across R_2 may be so large that the voltage across the phototube is inadequate.

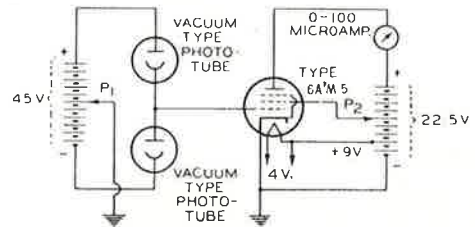

Fig. 7. Sensitive circuit for matching measurements.

Matching measurements of photometric qualities such as candlepower, colour, and turbidity can be made with high precision by means of the circuit shown in Fig. 7. This circuit can be used, for example, to determine whether the candlepower of a lamp is precisely equal to that of a standard lamp. For this use, the circuit is first adjusted so that the microammeter reads mid-scale when one phototube is exposed to light from the standard lamp and the other phototube is exposed to light from a comparison lamp. The standard lamp is then replaced by the unknown lamp. If the unknown lamp supplies exactly the same amount of light to the first phototube that the standard lamp did, the meter reading will be the same as for the standard lamp. However, if there is a difference, even though very small, between the

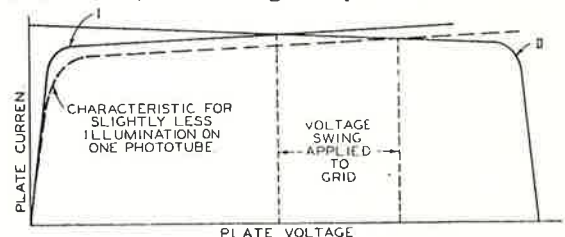

Fig. 8.

amounts of light supplied by the standard lamp and the unknown lamp, the bias applied to the 6AM5 will be different and the meter reading, therefore, will change. Thus, the circuit can be used to detect a very small mis-match between the lamps. By exposing the phototubes to light reflected from materials or transmitted by liquids, the circuit can also be used to match or measure colour, turbidity, and other photometric qualities.

The action of this circuit can be best understood by considering one phototube as the load for the other. In Fig. 8, Curve I is the current-voltage characteristic of one phototube; Curve II is the current-voltage characteristic of the other valve drawn as a load line on Curve I. The intersection of the two

curves gives the distribution of voltage across the phototubes because the phototubes, being in series, must pass the same current. When the circuit is so adjusted that the intersection is on the flat portion of the curves, a small change in the illumination on one phototube produces a large shift of the point of intersection. This is shown by the dashed-line curve which represents the current-voltage characteristic for one phototube under slightly decreased illumination. The wide shift in the intersection means a large change in the bias on the grid of the 6AM5. Consequently, the circuit has high sensitivity.

The circuit can be adjusted for operation as follows: Short-circuit the grid to the cathode of the 6AM5 and adjust contact P_2 so that the microammeter deflection is slightly less than full scale. This adjustment assures that, during the operation of the circuit, the plate current of the 6AM5 will not exceed the meter's full-scale value. Then remove the shorting connection from the grid and, with zero illumination on the phototubes, adjust P_1 so that the microammeter deflection is approximately mid-scale. Next set the illumination on one phototube at a convenient value and adjust the illumination on the other phototube so that the meter deflection is again mid-scale. The circuit is then ready for operation. This adjustment procedure compensates for differences in the insulation resistance and sensitivity of individual phototubes.

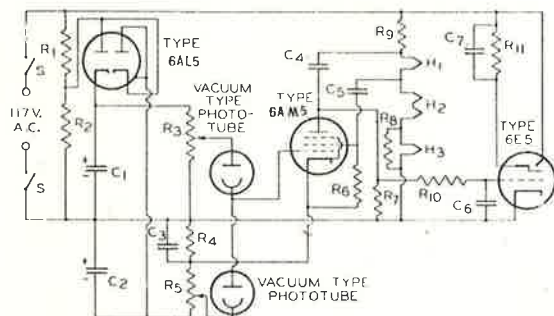

$H_1 = 6E5$ HEATER	$R_4 = 50,000$ OHMS, $\frac{1}{2}$ WATT
$H_2 = 6A5$ HEATER	$R_0, R_7, R_{11} = 2$ MEGOHMS, $\frac{1}{2}$ WATT
$H_3 = 6AM5$ HEATER	$R_8 = 30$ OHMS, $\frac{1}{2}$ WATT
$C_{11}, C_2, C_3 = 4$ μ f, 250 V.	$R_9 = 320$ OHMS, 30 WATTS
$C_4, C_7, C_6, C_7 = 0.1$ μ f, 200 V.	$R_{10} = 0.5$ MEGOHM, $\frac{1}{2}$ WATT
$R_1 = 15,000$ OHMS, $\frac{1}{2}$ WATT	$S =$ DOUBLE-POLE ON-OFF SWITCH
$R_2 = 100,000$ OHMS, $\frac{1}{2}$ WATT	
$R_3, R_5 = 1$ MEGOHM, $\frac{1}{2}$ WATT	

Fig. 9. A.C. operated sensitive circuit for matching measurements.

For high sensitivity, it is important that grid current in the 6AM5 be small. Emission current from the heater to the grid can be minimized by a positive bias of 9 volts applied to the heater, as indicated in Fig. 7. Leakage current to the grid can be made small by means of the precautions described in the fourth, fifth, and sixth paragraphs under INSTALLATION. The response of the meter to a change in illumination may be slow, especially at low light levels. The reason is that the dynamic resistance between the grid and the cathode of the 6AM5 may be so large that this resistance, when multiplied by the

input capacitance of the 6AM5, gives a large time constant.

A.C. operated circuit for matching measurements, Fig. 9

An a.c. operated circuit for matching measurements is shown in Fig. 9. This circuit employs two phototubes and a 6AM5 connected in the high-sensitivity arrangement of Fig. 7, but requires no battery or microammeter. Anode voltage is supplied to the phototubes by the 6A5 connected as a voltage-double rectifier. Positive plate and screen voltages are supplied to the 6AM5 and 6E5 on every other half-cycle of the a.c. line voltage. The magnitude of the plate current of the 6AM5 is indicated by the 6E5. The applications for this circuit are the same as those for the circuit of Fig. 7. The procedure for adjusting the circuit is similar to that for the circuit of Fig. 7. First, with zero illumination on the phototubes, set potentiometer R_3 at about the middle of its range and adjust R_5 so that the shadow angle of the 6E5 is half closed. Then apply a convenient value of illumination to one phototube and adjust the illumination on the other phototube so that the 6E5 shadow angle is again half closed. The circuit is then ready for operation. For illumination levels as low as 0.0001 lumen, an unbalance of $\frac{1}{4}$ of 1 per cent. in the light on the phototubes will cause the 6E5 shadow angle to open to 90° or close to 0° . This sensitive response is obtained only when leakage currents are made small as described in the fourth, fifth, and sixth paragraphs under INSTALLATION. At higher illumination levels, the 6E5 shadow angle gives full response to an even smaller percentage unbalance because the ratio of photoelectric current to leakage currents is larger.

Circuit for measurement of light-intensity ratios, Fig. 10

Ratios of light intensities can be measured by means of the circuit of Fig. 10. Within the operating range of this circuit, the reading it provides is not affected by variation in the absolute magnitudes of the light inputs to the two phototubes as long as the ratio between the light inputs remains constant. The applications of this circuit are similar to those of the circuit of Fig. 9. The circuit of Fig. 9 has the advantage that it can detect an extremely small inequality between two light sources. The circuit of Fig. 10 has the advantage that it can measure directly the ratio between the intensities of two sources.

The operation of this circuit is illustrated by the curves of Fig. 11. Condenser C_1 is charged by the a.c. line through the two phototubes. On one half-cycle of line voltage, the line charges C_1 through one phototube; on the next half-cycle, the line charges the condenser in the opposite direction through the other phototube. If the two phototubes have equal sensitivities and equal illuminations, the opposite charging effects of the two phototubes are equal, as indicated in Figs. 11a and 11b. Under this condition, the 6AV6 grid is at the same d.c. potential as the lower side of the a.c. line. If the light on phototube No. 1 is suddenly doubled, the d.c. voltage across condenser C_1 changes because C_1 receives more charge from

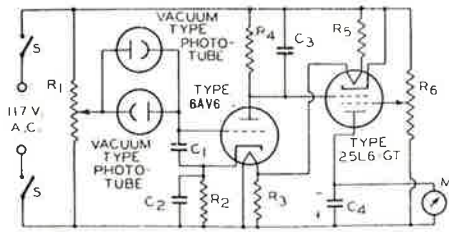

- $C_1 = 0.001 \mu\text{f}$
- $C_2 = 0.25 \mu\text{f}$
- $C_3 = 0.1 \mu\text{f}$
- $C_4 = 4 \mu\text{f}$
- M = D-C MILLIAMMETER (0-25 MA.)
- $R_1 = 20,000 \text{ OHMS, 1 WATT}$
- $R_2, R_3 = 0.25 \text{ MEGOHM, } \frac{1}{2} \text{ WATT}$
- $R_4 = 50 \text{ OHMS, 1 WATT}$
- $R_5 = 280 \text{ OHMS, 25 WATTS}$
- $R_6 = 20,000 \text{ OHMS, 5 WATTS}$
- S = DOUBLE-POLE ON-OFF SWITCH

Fig. 10. Circuit for measurement of light-intensity ratios.

phototube No. 1 than from No. 2. The d.c. voltage built up across C_1 reduces the time during which phototube No. 1 conducts current because the valve conducts only, of course, when its anode is positive with respect to its cathode. The condenser will finally charge up to an equilibrium voltage at which the conducting time of No. 1 is reduced enough so that the charge supplied to C_1 by No. 1 is equal to that supplied by No. 2, as indicated in Figs. 11d and 11e. This equilibrium voltage is determined by the ratio of the illuminations on the phototubes. For example, with twice as much illumination on No. 1 as on

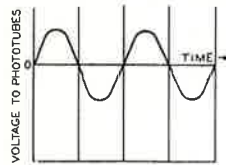

Fig. 11a—Equal illuminations on phototubes.

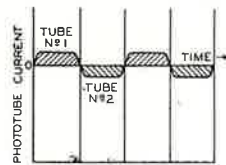

Fig. 11b—Equal illuminations on phototubes. Shaded areas = current \times time = charge. Algebraic sum of areas = zero.

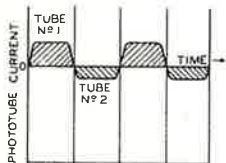

Fig. 11c—Light on No. 1 doubled. Shaded areas no longer add to zero.

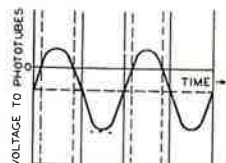

Fig. 11d—Light on No. 1 twice that on No. 2. C_1 charges up, shifting zero line, and reducing conduction time of No. 1.

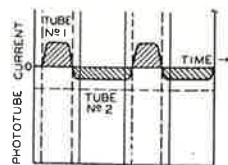

Fig. 11e—Equilibrium condition attained by circuit with twice as much light on No. 1 as on No. 2. Conduction time of No. 1 is reduced sufficiently so that shaded areas add to zero.

No. 2, the equilibrium voltage must be such that No. 2 conducts during approximately twice as much time as No. 1. The voltage across C_1 is amplified by the 6AV6 and controls the plate current of the 25L6-GT. The meter in the plate circuit of the 25L6-GT can be calibrated to show directly the illumination on one phototube as a multiple or fraction of that on the other.

The adjustment procedure for this circuit is as follows: Set the contact on R_6 at the upper end of R_6 , so that the screen of the 25L6-GT is at zero volts with respect to its cathode, and set the grid bias of the 25L6-GT at zero by short-circuiting R_4 . Increase the screen voltage of the 25L6-GT by means of R_6 until the plate current brings the meter M to full scale. Remove the shorting connection from R_4 and adjust R_1 so that the circuit operates best over the range of illumination ratios to be encountered in use of the circuit. The value shown for C_1 in Fig. 10 is for use with small values of light input. For larger values of light input, this capacitance should be made larger. The only undesirable effect of increasing this capacitance is that the circuit is made more sluggish in its response to changes in the ratio of light inputs.

Exposure-control circuit, Fig. 12

A circuit for automatically controlling photographic exposure time is shown in Fig. 12. This circuit is used in making photographic enlargements, photostats, microphotographs, etc. In use of the circuit, the phototube receives light reflected or transmitted from the film being exposed. The circuit measures the product of the intensity and duration

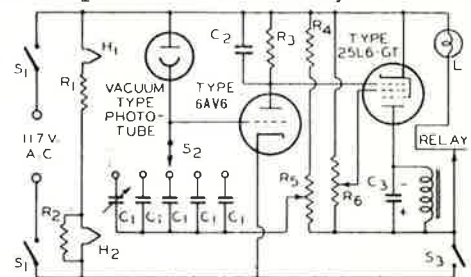

- $C_1 = 10-250 \mu\text{f, 0.001 } \mu\text{f, 0.01 } \mu\text{f, 0.1 } \mu\text{f, 1.0 } \mu\text{f}$
- $C_2 = 0.1 \mu\text{f}$
- $C_3 = 8 \mu\text{f, 250 V}$
- $H_1 = 25L6-GT \text{ HEATER}$
- $H_2 = 6AV6 \text{ HEATER}$
- L = LAMP OR SOLENOID-OPERATED SHUTTER
- $R_1 = 280 \text{ OHMS, 25 WATTS}$
- $R_2 = 50 \text{ OHMS, 1 WATT}$
- $R_3 = 1 \text{ MEGOHM}$
- $R_4, R_5 = 5000 \text{ OHMS, 1 WATT}$
- $R_6 = 10,000 \text{ OHMS, 2 WATTS}$
- RELAY SHOULD OPERATE ON 25 MA. OR LESS
- S1 = DOUBLE-POLE ON-OFF SWITCH

Fig. 12. Photographic-exposure control circuit.

of the illumination on the phototube and thus measures the exposure of the film. When the exposure has reached the desired value, the circuit automatically opens a relay which removes light from the film.

The circuit measures exposure by measuring the change in voltage across a condenser in series with the phototube. This voltage change is proportional to the charge supplied by the phototube. The charge is equal to the time integral of the current flowing

into the condenser through the phototube. Since the phototube current is proportional to the light coming to the phototube from the film, the change in voltage across the condenser is proportional to the exposure of the film.

In operation of the circuit, switch S_3 is first opened. Opening this switch applies full line voltage to the 6AV6 grid through R_4 , R_5 , C_1 and S_2 . Current flows from the grid to the cathode on positive half-cycles of the a.c. voltage until condenser C_1 is charged to a voltage approximately equal to the peak line voltage. This charging process takes only a fraction of a second. Switch S_3 is then closed. Closing the switch returns the positive side of C_1 to the 6AV6 cathode and thus applies the d.c. voltage across C_1 as negative bias to the 6AV6 grid. This negative bias cuts off plate current in the 6AV6 and reduces the voltage drop across R_3 , the bias voltage for the 25L6-GT grid, to zero. Closing switch S_3 also applies plate and screen voltage on the 25L6-GT. With plate and screen voltage on the 25L6-GT and with zero bias on its grid, the relay closes and exposure of the film and phototube starts. The phototube feeds positive charge into condenser C_1 and thus reduces the negative charge built up in the condenser during the time S_3 was open. As C_1 is discharged by the phototube, the 6AV6 grid becomes less negative and plate current starts to flow in the 6AV6. The flow of this current through R_3 produces a voltage drop across R_3 which makes the grid of the 25L6-GT negative with respect to its cathode and reduces the plate current through the relay. When C_1 is discharged by the phototube sufficiently, the relay current is reduced to the value at which the relay opens. In this way, the circuit cuts off the light on the film when exposure has reached the desired value.

The procedure for adjusting this circuit is to set the contact on R_6 at the upper end of R_6 , so that the voltage on the screen of the 25L6-GT is zero with respect to its cathode, and to connect the grid of the 25L6-GT to its cathode instead of to the 6AV6 plate. Increase the 25L6-GT screen voltage by means of R_6 until the relay current is a little larger than the value required to close the relay. Re-connect the 25L6-GT grid to the 6AV6 plate and the circuit is ready for operation. For control of exposure time, switch S_2 can be used as a coarse control and R_5 , as a fine control.

Circuit for measurement of very small values of illumination, Fig. 13

A circuit for measurement of very small values of illumination is shown in Fig. 13. This circuit can measure illuminations corresponding to a phototube current of only 10^{-10} ampere. The bridge arrange-

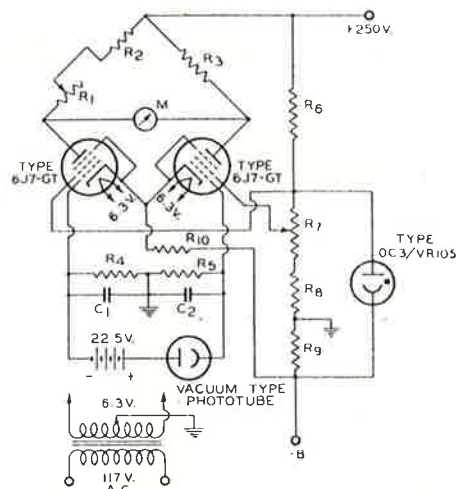

$R_1 = 1000$ OHMS, 1 WATT	$R_8 = 500$ OHMS, 1 WATT
$R_2, R_3 = 50,000$ OHMS, 1 WATT	$R_{10} = 1400$ OHMS, 1 WATT
$R_4, R_5 = 5$ MEGOHMS	$C_1, C_2 = 0.01$ μ f
$R_6 = 6,000$ OHMS, 4 WATTS	$M =$ MULTI-RANGE MICROAMMETER, 0-10, 0-100, 0-1000 MICROAMPERES.
$R_7 = 10,000$ OHMS, 1 WATT	
$R_9 = 2500$ OHMS, 1 WATT	

Fig. 13. Circuit for measurement of very small values of illumination.

ment of the circuit makes the zero setting practically independent of supply-voltage variations. The use of a voltage-regulated screen supply makes the sensitivity of the circuit very little affected by supply-voltage variations. Because the drain on the 22½-volt battery is only a fraction of a microampere, a small C battery will give good life.

The procedure for adjusting the circuit is to switch the microammeter to its 0-1,000 microampere scale, reduce the phototube illumination to zero, and bring the meter reading to zero by adjustment of R_7 as a coarse control and R_1 as a fine control. The circuit is then ready for operation. Because the variation of meter current with illumination is practically linear, the circuit can be calibrated at comparatively large values of illumination and the calibration can be extended to small illumination values. It is, of course, especially important in this circuit that phototube leakage currents be made small as described under INSTALLATION.

[The license extended to the purchaser of valves appears in the License Notice accompanying them. Information contained herein is furnished without assuming any obligations.]

References to books dealing with photocells and associated circuits

1. "Handbook of Industrial Electronic Circuits", by Markus and Zeluff, published by Mc-Graw Hill.
2. "Photoelectricity and its Application", by Zworykin and Ramberg, published by John Wiley.
3. "Photoelectric Cells in Industry", by Walker, published by Pitman.
4. "Photoelectric Cells", by Sommer, published by Methuen.

PHOTOTUBES

SPECTRAL SENSITIVITY CURVES

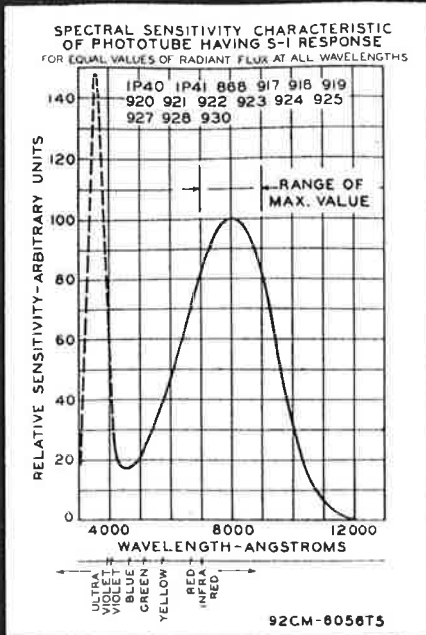

S-1 RESPONSE

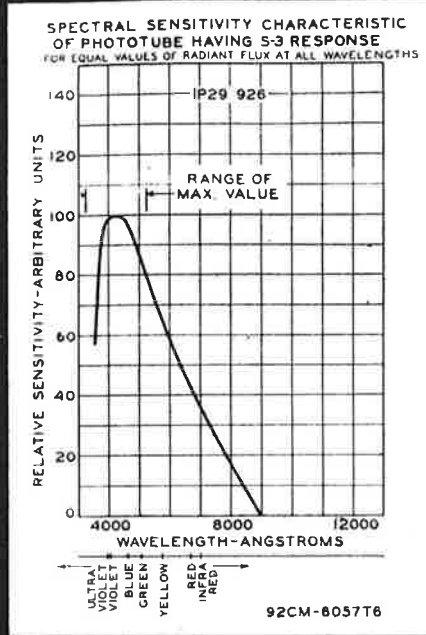

S-3 RESPONSE

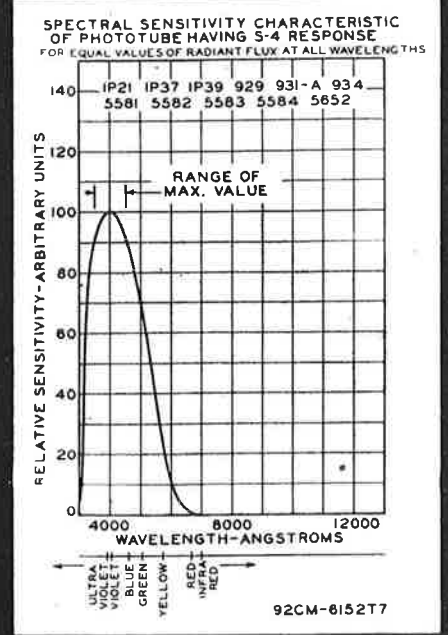

S-4 RESPONSE

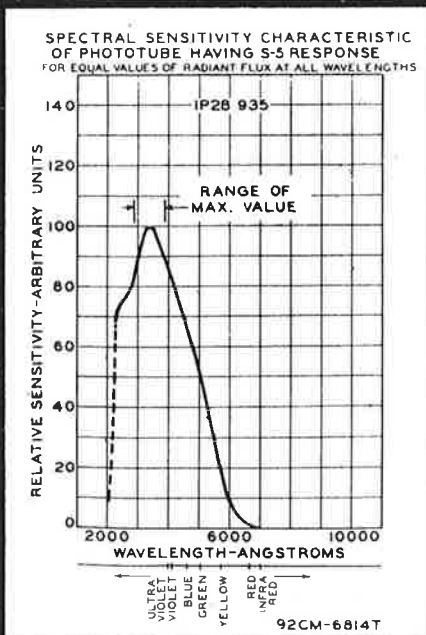

S-5 RESPONSE

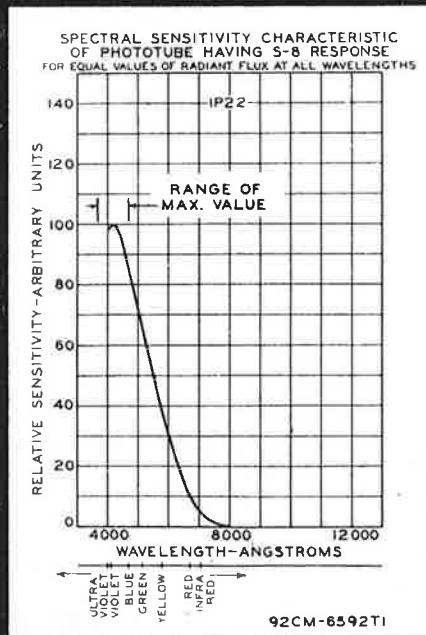

S-8 RESPONSE

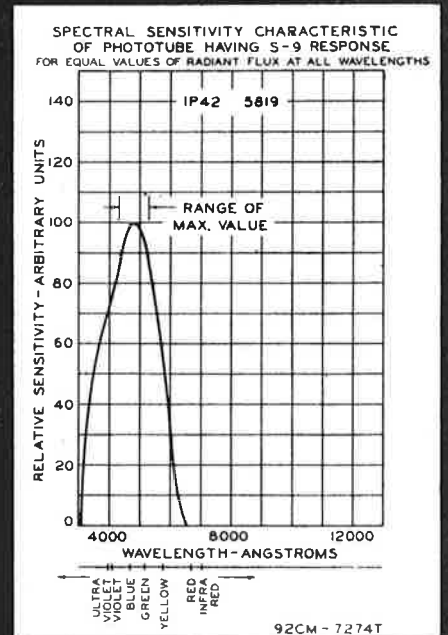

S-9 RESPONSE

The above curves give spectral sensitivity in relative units for the tube types listed on each curve in order to minimize the number of curves. In order to compare the sensitivity of one type with that of

another, the relative scale values should be converted to absolute values as follows: set the 100-unit value of the sensitivity scale equal to the absolute sensitivity value ($\mu\text{amp}/\mu\text{watt}$) which is obtained for each

type to be compared from pages 3 and 4. Other absolute sensitivity values on the curve may then be determined by reading values on the relative scale as percentages of the 100-unit absolute value.

Type	Description	Out-line	Spectral Characteristics				Maximum Ratings				Max. Gas Amplification Factor	Max. DC Anode Dark Current μ Amp.	Luminous Sensitivity †		
			Curve ψ	Max. Response Values		Anode-Supply Volts DC or Peak AC	Peak Cathode Current μ Amp.	Peak Cathode Current Density μ Amp./sq.in.	Average Cathode Current μ Amp.	μ Amp./Lumen					
				Wave-length Angstroms	Sensitivity μ Amp./ μ Watt					0 cps			5000 cps	10000 cps	
GAS TYPES															
IP29	For colorimetric applications.	4	S-3	4200	0.01	100	20	100	5†	9	0.10	40	35	31	
IP37	For sound reproduction from a dye-image soundtrack.	4	S-4	4000	0.125	100	20	100	5†	5.5	0.05	135	124	108	
IP40	Similar to 930 except for non-hygroscopic base. For applications critical as to leakage under high-humidity conditions.	9	S-1	8000	0.0135	90	10	100	3 ^a	10	0.005	135	111	101	
IP41	End-type (head-on operation). For relay applications.	15	S-1	8000	0.009	90	5	75	1.5 ^a	8.5	0.1	90	77	67	
868	For sound reproduction.	4	S-1	8000	0.009	100	20	100	5†	8	0.1	90	77	67	
918	For sound reproduction.	4	S-1	8000	0.015	90	20	100	5 ^a	10.5	0.1	150	120	105	
920	Twin-type. For push-pull sound reproduction from a double sound track.	5	S-1	8000	0.010	90	6	50	2 ^a	9	0.1	100	85	74	
921	Cartridge type. For relay applications.	17	S-1	8000	0.0135	90	10	100	3 ^a	10	0.1	135	119	108	
923	For renewal use. For new equipment use 1P40 or 930.	8	S-1	8000	0.0135	90	10	100	3 ^a	10	0.1	135	111	101	
924	For renewal use. For new equipment, 1P41 is recommended.	14	S-1	8000	0.009	90	5	75	1.5 ^a	8.5	0.1	90	77	67	
927	For 16-mm sound equipment.	13	S-1	8000	0.0125	90	6	100	2 ^a	10	0.1	125	110	100	
928	Non-directional type. For relay applications.	7	S-1	8000	0.0065	90	10	100	3 ^a	10	0.1	65	56	50	
930	For sound reproduction and relay applications.	9	S-1	8000	0.0135	90	10	100	3 ^a	10	0.1	135	111	101	
5581	5581, 5582, 5583, 5584 are similar to types 930, 921, 927, and 920, respectively, except for S-4 response. For sound reproduction involving a dye-image sound track in conjunction with an incandescent light source.	9	S-4	4000	0.125	100	10	100	3†	5.5	0.050	135	124	108	
5582		17	S-4	4000	0.11	100	10	100	2†	5.5	0.050	120	110	96	
5583		12	S-4	4000	0.125	100	10	100	2†	5.5	0.050	135	124	108	
5584		5	S-4	4000	0.11	100	10	50	2†	5.5	0.050	120	110	96	
VACUUM TYPES															
IP39	Similar to 929 except for non-hygroscopic base. For applications critical as to leakage under high-humidity conditions.	9	S-4	4000	0.042	250	20	100	5	—	0.005	45	45	45	
IP42	Small, head-on type. Only 1/4" diameter. For applications where space limitation is a factor.	18	S-9	4800	0.020	180	1.5	100	0.4	—	0.005	30	30	30	
917 919	Low leakage types which are alike except that 917 has anode connected to top cap, whereas 919 has cathode connected to top cap. For light-measuring and relay applications.	2	S-1	8000	0.002	500	30	100	10	—	0.005	20	20	20	

♦ For dimensional outlines, see pages 6 and 7
 * For spectral sensitivity curves, see page 5.
 ■ At 90 volts for all gas types; 250 volts for all vacuum types except IP42 which is taken at 180 volts. Measured at 25°C for all types.

Note: The maximum ambient temperature is 100°C for types having S-1 and S-3 response and 75°C for types having S-4, S-5, and S-9 response.
 † Averaged over any interval of 30 seconds maximum.
 ‡ Measured with 2870°K light source.

† May be doubled when anode-supply voltage is limited to 80 volts.
 a May be doubled when anode-supply voltage is limited to 70 volts.
 Note 2: Direction of light is into concave side of cathode.

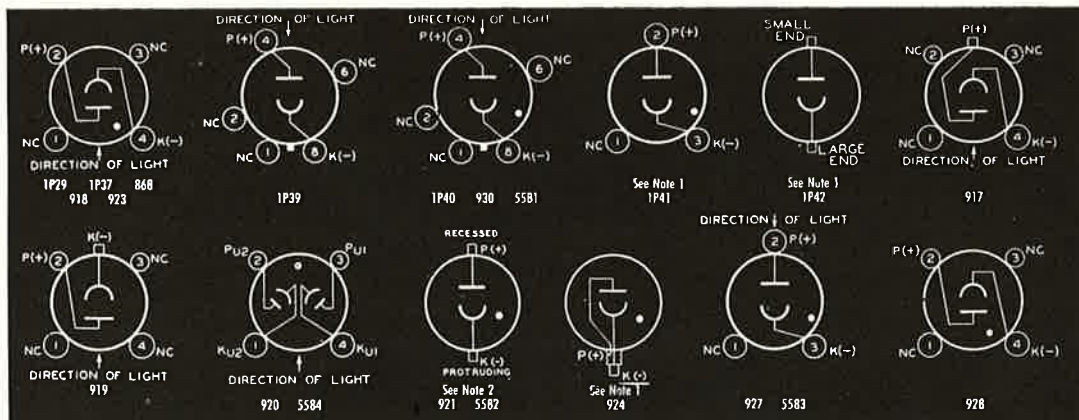

SINGLE- AND TWIN-UNIT TYPES

Type	Description	Out-line	Spectral Characteristics				Maximum Ratings				Max. Gas Amplification Factor	Max. DC Anode Dark Current [Ⓜ] μAmp.	Luminous Sensitivity†		
			Curve [Ⓢ]	Max. Response Values		Anode-Supply Volts DC or Peak AC	Peak Cathode Current μAmp.	Peak Cathode Current Density μAmp./sq. in.	Average Cathode Current μAmp.	μAmp./Lumen					
				Wave-length Angstroms	Sensitivity † μAmp./μWatt					0 cps			5000 cps	10000 cps	
922	Cartridge type. For relay applications.	16	S-1	8000	0.002	500	15	100	5	—	0.005	20	20	20	
925	Short-bulb type. For relay applications.	11	S-1	8000	0.002	250	15	100	5	—	0.0125	20	20	20	
926	Cartridge type. For colorimetric applications.	17	S-3	4200	0.0016	500	15	100	5	—	0.005	6.5	6.5	6.5	
929	For light-measuring and relay applications.	9	S-4	4000	0.042	250	20	100	5	—	0.0125	45	45	45	
934	For sound and facsimile equipment.	13	S-4	4000	0.028	250	12	100	4	—	0.005	30	30	30	
935	For ultraviolet measurement applications.	3	S-5	3400	0.032	250	30	100	70	—	0.0005	35	35	35	
5652	Twin type having two composite anode-cathodes. For facsimile service.	10	S-4	4000	0.042	250	12*	100	4*	—	0.01	45	45	45	

VACUUM TYPES—Cont'd

MULTIPLIER TYPES

Type	Description	Out-line	Spectral Characteristics				Maximum Ratings					Max. DC Anode Dark Current [Ⓜ] μAmp.	Anode Luminous Sensitivity † Amp./Lumen	Equivalent Noise Input ‡ Lumen	Current Amplification [Ⓢ] †
			Curve [Ⓢ]	Max. Response Values		Anode-Supply Volts DC or Peak AC	Supply Volts Between Final Dynode and Anode	Peak Anode Current Ma	Average Anode Current [Ⓢ] Ma	Ambient Temperature °C					
				Wave-length Angstroms	Sensitivity † μAmp./μWatt										
IP21	Similar to 931-A but intended for applications involving extremely high sensitivity.	6	S-4	4000	74000	1250	250	1.0	0.1	75	0.1	80	5x10 ⁻¹³	2x10 ⁶	
IP22	High-sensitivity type having response similar to that of eye.	6	S-8	4200	370	1250	250	10	1.0	50	0.25	0.6	1x10 ⁻¹⁰	2x10 ⁵	
IP28	High-sensitivity type for ultraviolet measurement applications.	6	S-5	3400	22600	1250	250	5	0.5	75	0.1	20	7x10 ⁻¹² §	1x10 ⁶	
931-A	High-sensitivity type for facsimile transmission, sound reproduction, and research.	6	S-4	4000	18600	1250	250	10	1.0	75	0.1	20	7x10 ⁻¹²	1x10 ⁶	
5819	Head-on type for scintillation counters, and in other applications involving low-level, large-area light sources.	1	S-9	4800	14900 ^Δ	1250	150	7.5	0.75	75	0.05	24 ^Δ	2x10 ⁻¹¹ ^Δ	6x10 ⁵ ^Δ	

For key to base and envelope connection diagrams, see page 10.
 Ⓢ For dimensional outlines, see pages 6 and 7.
 Ⓢ For spectral sensitivity curves, see page 5.
 □ Referred to cathode. ○ At 25°C.
 † Measured with 2870°K light source.
 * Averaged over any interval of 30 seconds maximum.
 ★ For either electrode. * DC or Peak AC.
 † Ratio of anode sensitivity to cathode sensitivity.
 § Ultraviolet equivalent noise input = 6x10⁻¹⁵ watt.
 Note 1: Direction of light is into end of bulb.
 Note 2: Direction of light is into concave side of cathode.
 ‡ With 100 volts per dynode stage and 100 volts between final dynode and anode.
 Δ With 90 volts per dynode stage and 90 volts between final dynode and anode.
 Note: Equivalent noise input is measured with a 2870°K light source at a 25°C tube temperature for a bandwidth of one cps.

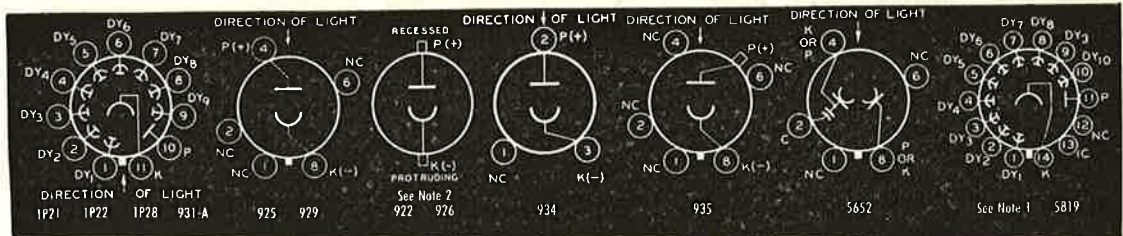

PHOTOTUBES

DIMENSIONAL OUTLINES

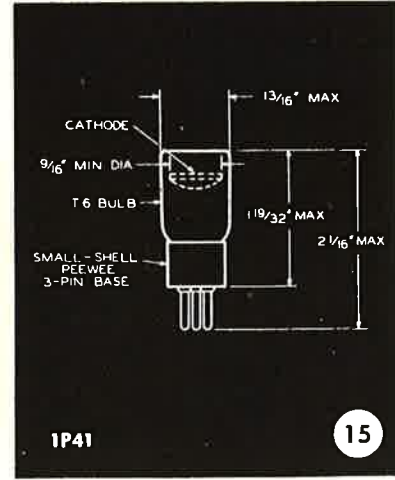
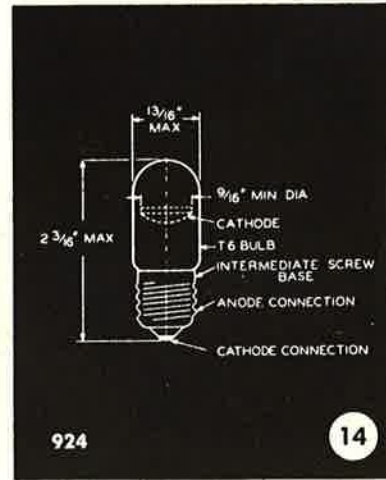
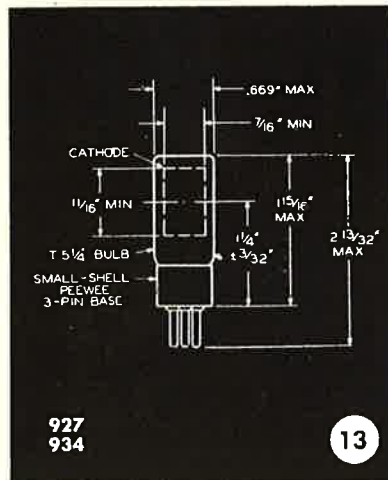
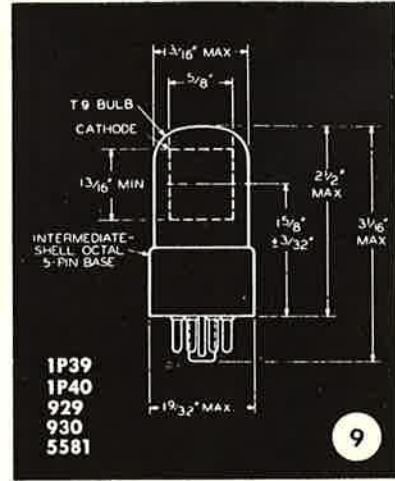
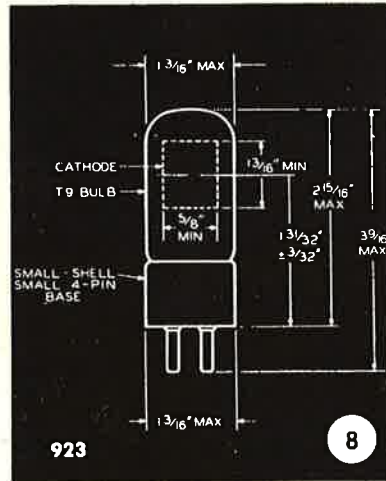
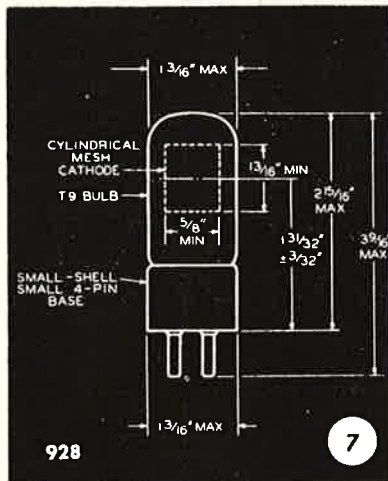
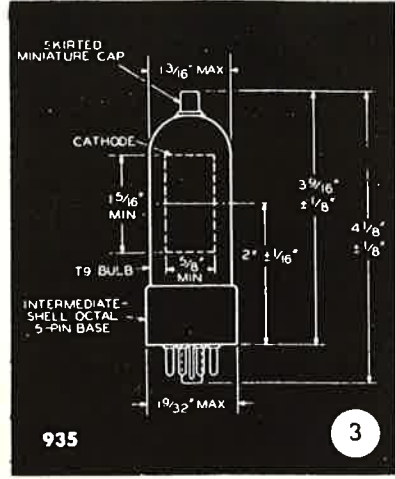
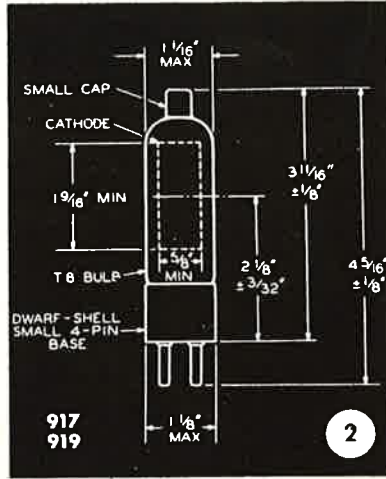
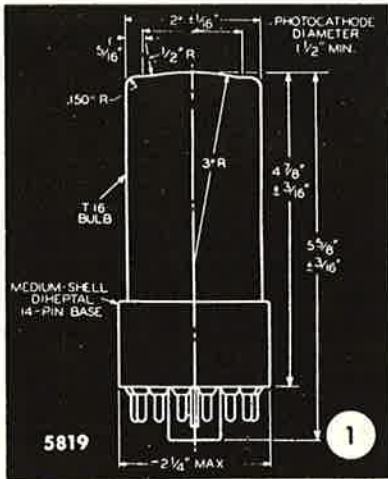

PHOTOTUBES

DIMENSIONAL OUTLINES

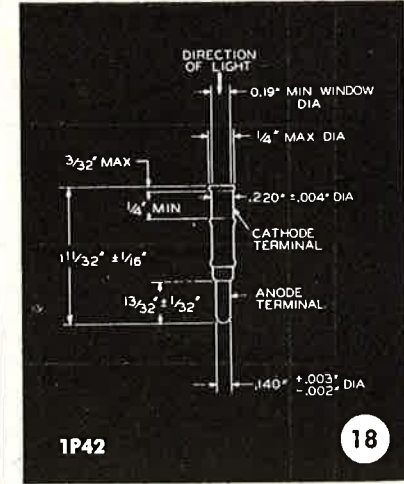
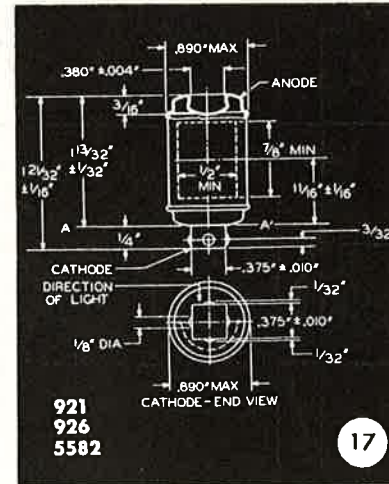
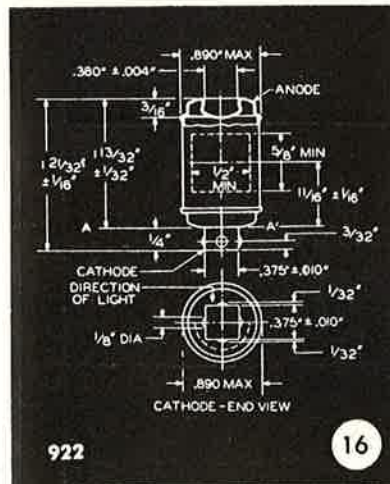
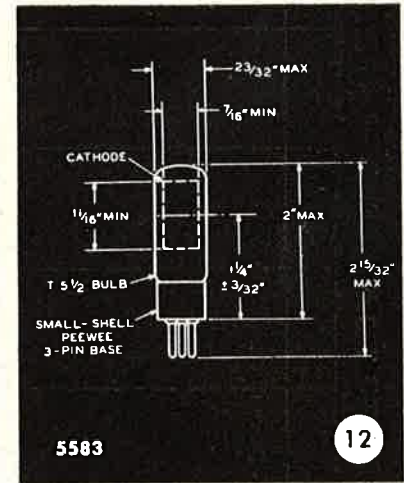
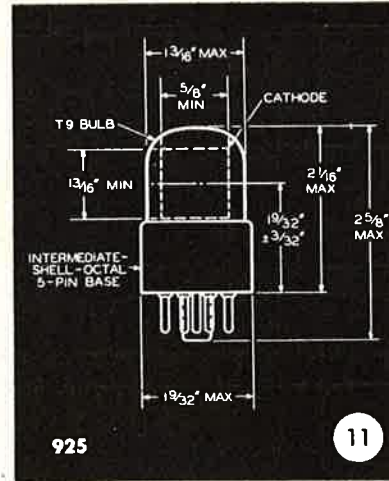
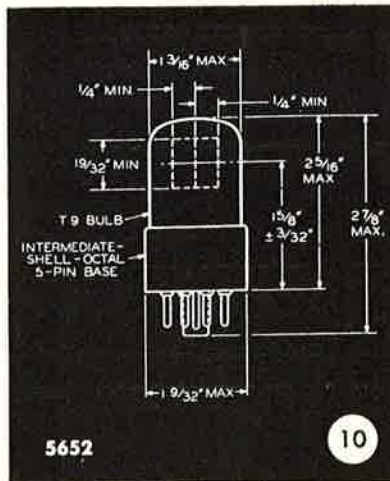
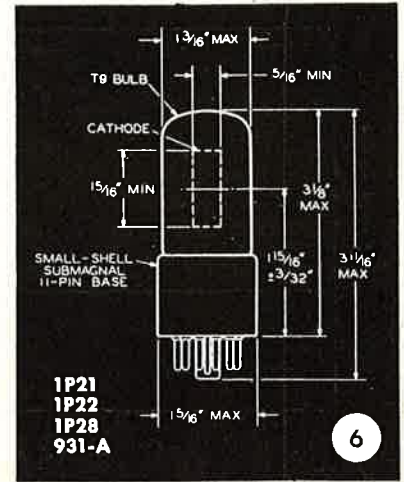
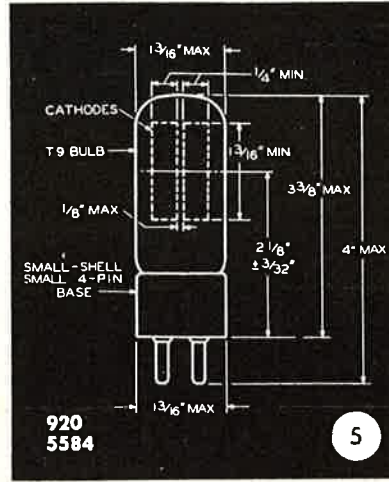
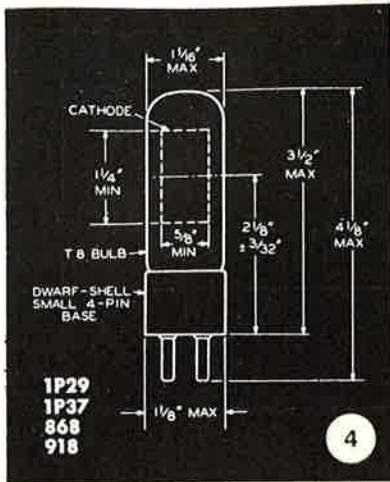

INTERCHANGEABILITY CHART

GAS TYPES

CINTEL	BASE	RCA	CETRON	VISITRON	GE	WTHSE	NU	LUMTRN	RAY	SYL	GEC	MAZDA
GS16	English 4 Pin											
GS16SO	Octal 5 Pin	930	CE30	(R61A) (R64A)	GL930		NU30	G5			CMG22	
GS16WB	Loose Leads										CMG17 CMG25 CMG8	
GS17	English 4 Pin											
GS18	English 4 Pin											
GS26T	English 4 Pin											
GS44X	U.S.A. 3 Pin			R51A			NU5 NU36	(G15F) (G16)				PE7B
GS44Y	U.S.A. 3 Pin											
GS46	English 4 Pin											
GS47X	U.S.A. 3 Pin	927	CE25		GL927		NU4					
GS116A	U.S.A. 4 Pin											
GS116AM	U.S.A. 4 Pin			R58A				G12				
GS117A	U.S.A. 4 Pin			R71A			NU2		4GC	814A		
GS117ATA	U.S.A. 4 Pin			R71TA			NU13					
GS146	U.S.A. 4 Pin	868	CE1	R59A	PJ23	WL735	NU1	G8	4GSM	868		
GS118TA	U.S.A. 4 Pin			R59TA								
GS126A	U.S.A. 4 Pin											
GS146 (Spec.)	U.S.A. 4 Pin	918	CE7		GL918		NU7					
GS149	U.S.A. 4 Pin	920			GL920							

VACUUM TYPES

CINTEL	BASE	RCA	CETRON	VISITRON	GE	WTHSE	NU	LUMTRN	RAY	SYL	GEC	MAZDA
VA16SO	Octal 5 Pin	929			GL929							
VS16SO	Octal 5 Pin *	925	CE30V	(R61AV) (R64AV)			NU30V					PE8
VS18BO	English 4 Pin											
VA25X	U.S.A. 3 Pin	934		R51BV								KG7
VA26T	English 4 Pin											
VS44X	U.S.A. 3 Pin											
VS44Y	U.S.A. Short 3 Pin											
VS116AM	U.S.A. 4 Pin			R51AV			NU25V					
VA117A	U.S.A. 4 Pin			R58AV								
VA117ATA	U.S.A. 4 Pin			R71BV								
VS117A	U.S.A. 4 Pin			R71TBV								
VS117ATA	U.S.A. 4 Pin			R71AV								
VS117ATA	U.S.A. 4 Pin			R71TA			NU13V					
VS118	U.S.A. 4 Pin	919	CE13V	R59AV		WL734						
VS118T	U.S.A. 4 Pin		CE1V	R82AV								
VS118TA	U.S.A. 4 Pin	917	CE11V	R59TAV	GL917		NU31V NU11V					

Bold face types are standard low-priced cells, available ex Australian or U.K. stock.
Light face types are special cells with longer delivery times.