

RESTRICTED

INSTRUCTION BOOK

FOR

RADIO RECEIVING EQUIPMENT MODEL RCH

**FREQUENCY RANGE 80 TO 560 KC. AND 1.9 TO 24 MCS.
SUPPLY 115 VOLTS, 60 CYCLES. ONE PHASE**

**NAVY DEPARTMENT
BUREAU OF SHIPS**

CONTRACTOR

**E. H. SCOTT RADIO LABORATORIES, INC.
CHICAGO, ILL., U. S. A.**

CONTRACT NXSS-24276

CONTRACT DATE FEB. 24, 1943

RESTRICTED

This instruction book is furnished for the information of commissioned, warrant, enlisted and civilian personnel of the Navy whose duties involve design, instruction, operation and installation of radio and sound equipment. The word "RESTRICTED" as applied to this instruction book signifies that this instruction book is to be read only by the above personnel, and that the contents of it should not be made known to persons not connected with the Navy.

GUARANTEE

All items used in this equipment, except vacuum tubes will be guaranteed by the contractor for a period extending one year from the installation date of the equipment, provided that in no case will the guarantee extend longer than two years, after the date of acceptance. This guarantee will cover items failing in normal operation and the contractor will replace these at no cost to the Government and with transportation charges prepaid to destination. If the contractor elects to have the defective unit returned to his plant for examination, he will be required to pay the transportation charges.

Contract No. NXSS 24276

Date of Contract Feb. 24, 1943

Serial Number of Equipment.....
Date of Acceptance by the Navy.....
Date of Delivery to Contract Destination.....
Date of Completion of Installation.....
Date Placed in Service

TABLE OF CONTENTS

SECTION	SUBJECT	PAGE
1	GENERAL	1
	1.1 Introduction	1
	1.2 Tube Complement	2
	1.3 Dimensions and Weights.....	2
	1.4 Power Requirements	3
	1.5 Antenna Requirements	3
2	DESCRIPTION	3
	2.1 Construction	3
	2.2 Circuit Description	8
	2.21 General Description	8
	2.22 Signal Frequency Circuits.....	8
	2.23 H.F. Oscillator Circuits.....	11
	2.24 I.F. Amplifier Circuits.....	11
	2.25 Second Detector Circuits.....	12
	2.26 C.W. Oscillator Circuits.....	12
	2.27 A.V.C. Circuits	12
	2.28 Audio Circuits	12
	2.29 Reception Switch Circuits.....	13
	2.210 Phone Control Circuits.....	13

(Continued on next page)

TABLE OF CONTENTS (Continued)

SECTION	SUBJECT	PAGE
2.3	Performance Data and Curves.....	13
	Plate 1. Sensitivity vs. Frequency.....	15
	Plate 2. Overall Selectivity	16
	Plate 3. Image Attenuation	17
	Plate 4. AVC Characteristics	18
	Plate 5. Overall Fidelity Characteristic.....	19
3	INSTALLATION	20
4	ALIGNMENT DATA	20
	4.1 General	20
	4.2 I.F. Amplifier Alignment.....	21
	4.3 H.F. Oscillator Alignment.....	21
	4.4 R.F. Amplifier Alignment.....	22
5	OPERATION	23
6	MAINTENANCE	25
	6.1 General	25
	6.2 Tube Replacement	25
	6.3 Failure of Receiver.....	25
	6.4 Test Data	26

(Continued on next page)

TABLE OF CONTENTS *(Continued)*

SECTION	SUBJECT	PAGE
7 PARTS LISTS AND MISCELLANEOUS		
	7.1 List of Major Units.....	32
	7.2 Parts List by Symbol Designations.....	33
	7.3 Parts List by Navy Type Designations.....	46
	7.4 Spare Parts List.....	48
	7.5 Resistor and Condenser Color Codes.....	55
	7.6 List of Manufacturers.....	57
 DIAGRAMS AND FIGURES		
	Dwg. No. 1.31. Outline Drawing of Model RCH Radio Receiving Equipment	3
	Fig. 1 Left Front Oblique View, Radio Receiver.....	v
	Fig. 2 Left Rear Oblique View, Radio Receiver.....	v
	Fig. 2.13 Top View Radio Receiver Chassis.....	5
	Fig. 2.15 Right Bottom Oblique View, Radio Receiver Chassis.....	5
	Fig. 2.18 Left Oblique Inverted View, Antenna Compartment.....	6
	Fig. 2.19 Bottom Oblique View, R.F. and H.F. Osc. Compartment	6
	Fig. 2.111 Left Bottom Oblique View, Radio Receiver Chassis.....	7
	Fig. 2.2 Actual Schematic Diagram, Type CZC-46209 Radio Receiver	9
	Fig. 2.21 Schematic Diagram of Circuit Description.....	10

MODEL RCH RADIO RECEIVING EQUIPMENT

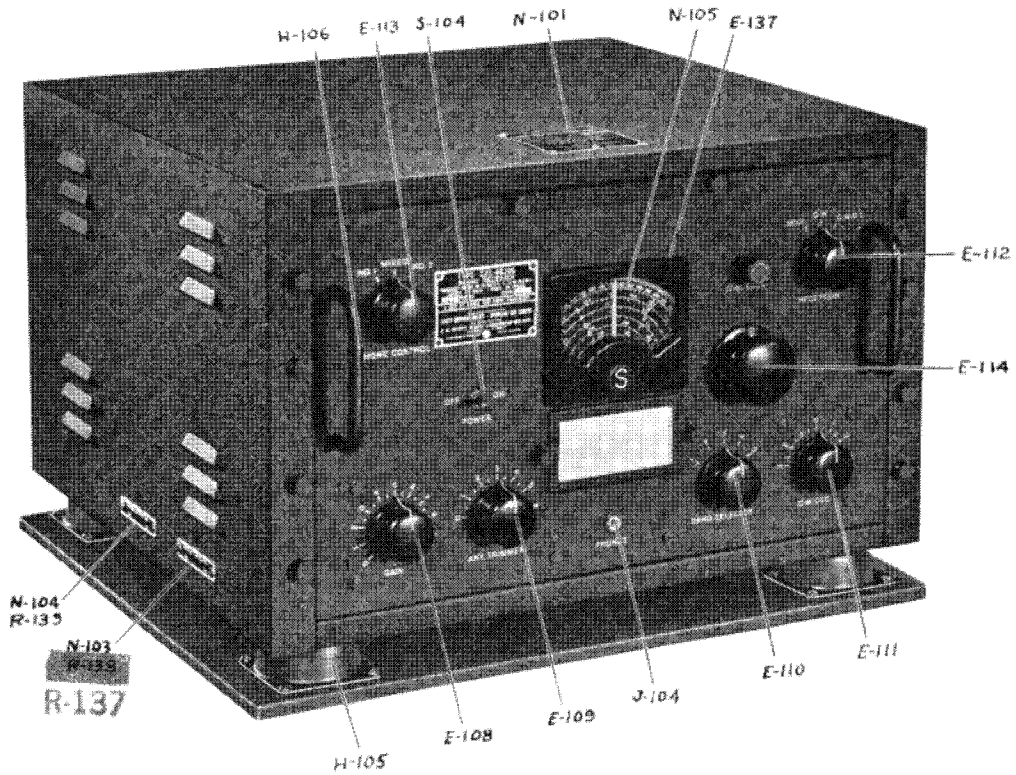

FIG. 1 LEFT FRONT OBLIQUE VIEW, RADIO RECEIVER

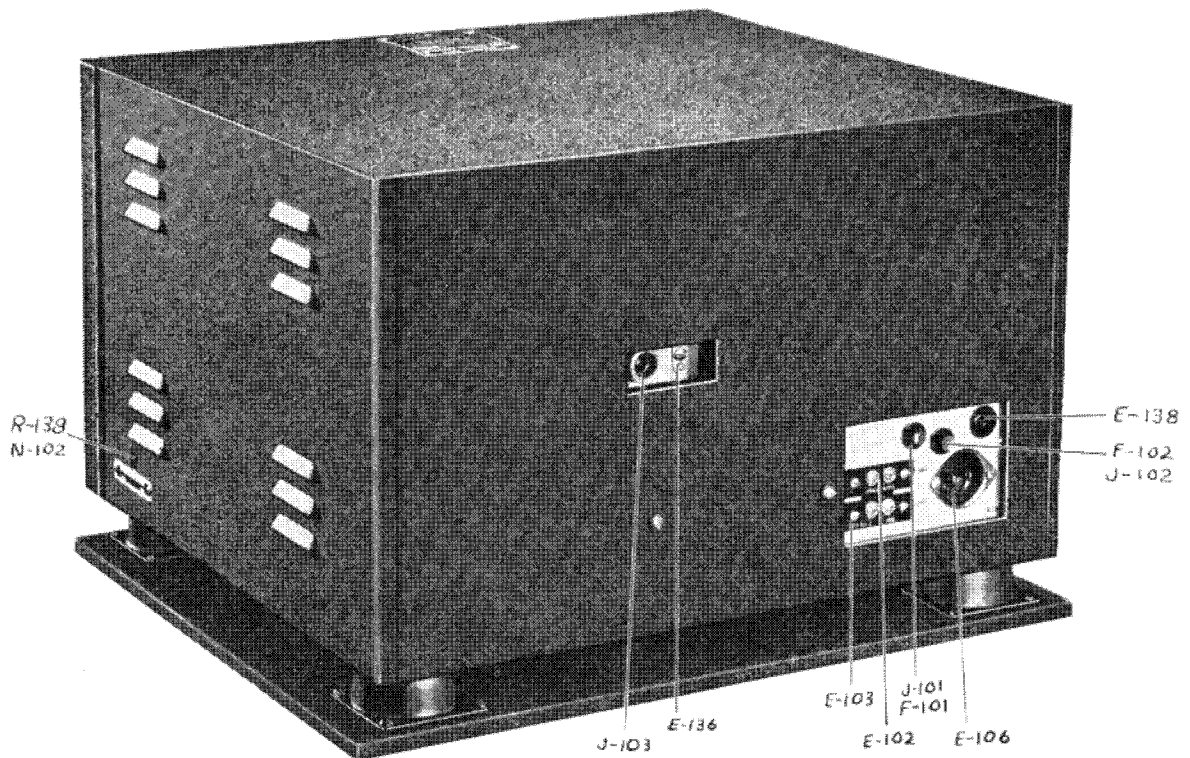

FIG. 2 LEFT REAR OBLIQUE VIEW, RADIO RECEIVER

1. GENERAL

1.1 INTRODUCTION

- 1.101 These instructions cover the installation, operation, and servicing of the Model RCH Radio Receiving Equipment. **THEY SHOULD BE READ AND STUDIED WITH GREAT CARE BEFORE THE INSTALLATION OR OPERATION OF THE EQUIPMENT IS ATTEMPTED IN ORDER THAT OPTIMUM PERFORMANCE MAY BE OBTAINED.**
- 1.102 The Model RCH Radio Receiving Equipment is suitable and is primarily intended for use aboard Naval vessels. It is equally suitable for use at Naval Radio shore stations.
- 1.103 The receiving equipment covers the frequency ranges of 80 to 560 kilocycles and 1.9 to 24 megacycles in five frequency bands. The equipment is suitable for the reception of radio telephone or telegraph signals (either CW or MCW) by either head telephone or loudspeaker methods.
- 1.104 Special circuits and features are incorporated in the Model RCH Radio Receiving Equipment to preclude its oscillator feeding voltages into the antenna circuit and radiating interferences which could be detected by sensitive radio receiving or radio direction finding equipments in the same, or close vicinity.
- 1.105 The receiving equipment is designed for AC operation, being equipped with a self-contained rectifier type power supply for supplying all operating voltages required from an a-c source of 110/125 volts, 58/62 cycles, single phase.
- 1.106 The receiving equipment is designed to permit the use of one pair of head-telephones (either 600 ohm or 2000 ohm impedance) separately or in conjunction with a suitable local loudspeaker, of the permanent magnet type, coupled to the equipment by means of a 600 ohm matching transformer.
- 1.107 The receiving equipment employs the cabinet type of construction and is designed for installation on top of an operating table or bench by means of a cradle type shock mounting supplied with the equipment. The chassis is of such design and construction as to be amenable to mounting in a standard cabinet type relay rack. Loudspeakers are not furnished as part of the complete equipment.
- 1.108 The equipment is supplied with one set of vacuum tubes contained within the Type CZC-46209 Radio Receiver. Two instruction books, one set of spare parts, and two pairs of head telephones are also supplied with each equipment.
- 1.109 The net weights and overall dimensions of the major unit of the complete equipment are listed in Par. 1.3.
- 1.110 The Type CZC-46209 Radio Receiver is an 11 tube superheterodyne covering the frequency ranges of 80 to 560 kilocycles, and 1.9 to 24 megacycles in five frequency bands as follows:
- BAND #1 — 80 to 220 kilocycles
 - BAND #2 — 210 to 560 kilocycles
 - BAND #3 — 1.9 to 5.1 megacycles
 - BAND #4 — 4.5 to 12 megacycles
 - BAND #5 — 8.8 to 24 megacycles
- 1.111 This major unit employs the cabinet type of construction, with the cabinet suitably shock mounted and designed for top of table or bench mounting. The chassis design and construction are such that the chassis may be mounted in a standard cabinet type, relay rack. However this type of mounting is not recommended for installations where the equipment will be subjected to severe shock or vibration, owing to the fact, that it can be accomplished only with the sacrifice of the shock mounting feature.
- 1.112 The major unit contains on a single chassis, all apparatus, (including power supply) necessary for taking energy from an antenna, amplifying and converting such energy into intermediate frequency energy, amplifying the intermediate frequency energy and then demodulating such energy into audio frequency energy for delivery, through an audio frequency amplifier to a phone jack on the front operating panel and a set of loudspeaker terminals at the rear of the chassis.
- 1.113 The electrical circuits of the Type CZC-46209 Radio Receiver employed for signal reception on all bands comprises one stage of radio frequency amplification, first detector (or mixer), a separate high frequency oscillator, two stages of intermediate frequency amplification operating at 585 kilocycles, a diode type second detector, one stage of resistance coupled audio amplification and an audio frequency power output stage. The second detector utilizes one set of elements of a dual diode tube, the other set of elements is utilized for a peak noise limiter. The resistance coupled audio stage utilizes the triode section of a dual diode Hi-Mu triode tube, the two elements of this tube are connected in parallel and utilized for delayed

MODEL RCH RADIO RECEIVING EQUIPMENT

automatic volume control. A CW oscillator is coupled to the second detector to provide for CW reception. A dual diode tube is connected between the audio frequency amplifier tube and the power output tube and is utilized as a limiter tube for CW reception to keep the audio output signal at a constant level.

1.114 The power supply section of the receiver, which is employed for supplying the necessary operating voltages for the receiver circuits, is designed for operation from a 110/125 volt, 58/62 cycles, single phase source of a-c supply. The power supply includes a power transformer with r-f input filters and primary fuses, a full wave vacuum tube rectifier and a two-section a-f filter.

1.115 Two audio output circuits are provided:

- (1) A phone jack is mounted on the front panel. The output from this jack can be adjusted to suit the operators desire, by means of the screw-driver control on the left side of the cabinet, marked "PHONE OUTPUT ADJ.". The load impedance of the phone output circuit can be adjusted for either 600 ohms or 20,000 ohms by inserting a link in the proper terminals on the left side of the chassis, marked 600 ohms and 20,000 ohms.

- (2) Terminals are provided at the rear of the chassis for connection of a loudspeaker of the permanent magnet type. The correct load impedance of the speaker output circuit is 600 ohms, and the undistorted audio power available at these terminals is nominally 2 watts.

1.116 A concentric jack, Navy Type 49120, is mounted at the rear of the chassis of the Type CZC-46209 Radio Receiver for antenna and ground connection. A hole in the rear of the cabinet provides access to the jack. A concentric plug, Navy Type 49121A which mates with the concentric jack, is furnished as part of the complete Model RCH Equipment, but with no antenna or ground leads attached.

1.117 A power receptacle and mating plug are also provided at the rear of the chassis for a-c power input connection. No power input cable is furnished.

1.118 The fuses in the primary circuit of the power supply, are mounted adjacent to the power input receptacle at the rear of the receiver chassis. The fuse mount-

ings are of such design that the fuses which are of the miniature cartridge type are replaceable without removing the receiver from its cabinet.

1.119 A two prong polarized receptacle E-138 is provided at the rear of the receiver chassis, a mating plug is also furnished. When an Inverter is used to supply 115 volts 60 cycle a-c for operation of the Type CZC-46209 Radio Receiver, this receptacle should be connected to the power switch S-104 as shown in the insert of the circuit diagram Fig. 2.2. The power switch is then used to control the DC supply to the Inverter and thus nullifies the need to turn on and off both the Inverter and Radio Receiver.

1.120 Terminals are provided at the rear of the receiver chassis marked "SET No. 2" so that the output of a second receiver may be connected to the PHONE CONTROL switch, providing audio signals at the phone jack and speaker terminals from:

No. 1 Position—The Type CZC-46209 Radio Receiver

No. 2 Position—The Type CZC-46209 Receiver and Set No. 2 simultaneously

No. 3 Position—The No. 2 Receiver

1.2 TUBE COMPLEMENT

1.21 The vacuum tubes employed in the Type CZC-46209 Radio Receiver are as follows:

<i>Symbol</i>	<i>Commercial and Navy Type</i>	<i>Function</i>
V-101	6K7	R.F. Amplifier
V-102	6J5	H.F. Oscillator
V-103	6SA7	First Detector and Mixer
V-104	6SK7GT	First I.F. Amplifier
V-105	6SK7GT	Second I.F. Amplifier
V-106	6SJ7	C.W. Oscillator
V-107	6H6GT	Second Detector, N.L.
V-108	6SQ7GT	First A.F. Amplifier, AVC
V-109	6H6GT	Output Limiter
V-110	6V6GT	A.F. Power Amplifier
V-111	5Y3GT	Rectifier (Full Wave)

1.3 DIMENSIONS AND WEIGHTS

1.31 The dimensions and weights of the Type CZC-46209 Radio Receiver are as follows:

(1) *Dimensions:*

	<i>Chassis in cabinet</i>	<i>Chassis only</i>
Length	21 inches	19 inches
Depth	20 $\frac{1}{8}$ inches	20 $\frac{1}{8}$ inches
Height	13 $\frac{7}{8}$ inches	10 $\frac{1}{2}$ inches

(*Weights*)

Chassis in cabinet —	106 pounds
Chassis only —	69 pounds

MODEL RCH RADIO RECEIVING EQUIPMENT

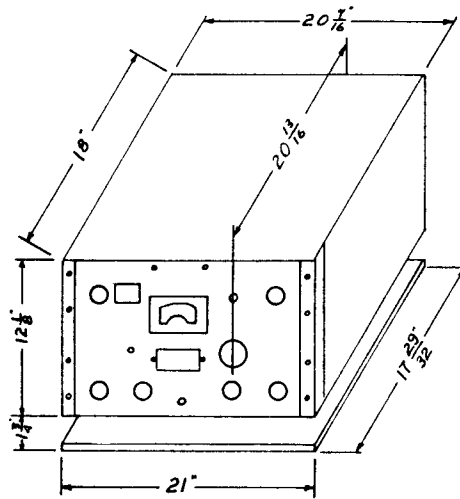

TYPE CZC-46209
RADIO RECEIVER
WEIGHT 106 LBS.

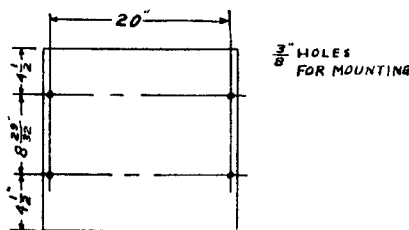

MOUNTING BASE

DWG 1.31

1.4 POWER REQUIREMENTS

1.41 The Model RCH Radio Receiving Equipment is designed for operation from a 110/125 volt, 58/62 cycle, single phase power source. The line current at 115 volts is 0.75 amperes. The nominal power consumption at 115 volts is 85 watts.

1.5 ANTENNA REQUIREMENTS

1.51 The input circuit of the Type CZC-46209 Radio Receiver is so arranged as to be suitable for use with either a balanced feed-line or a single wire antenna system. The dimensions of the single wire antenna are not critical, the recommended minimum over-all length of antenna and lead-in is seventy-five feet, the recommended maximum over-all length is two hundred feet. The antenna should be spaced at least six feet away from any parallel stay, mast or stack. It should be well insulated and should be

erected as high as possible. A one half megohm static-drain resistor should be permanently installed between the antenna and ground.

1.52 In an installation having a simple antenna-ground combination, solder the antenna lead-in to the center prong of the Type 49121A concentric plug. Connect the shell of the concentric plug to the ground terminal E-136 using a lead of sufficient length as to enable the plug to be removed or inserted into the antenna jack. In an installation having a balanced feed line, connect one side of the line to the center prong of the concentric plug, connect the other side of the line to the shell of the plug. In an installation having a concentric feed line, connect the outer conductor to the shell of the concentric plug, connect the inner conductor to the center prong of the concentric plug, the outer conductor must then be grounded to the ground terminal E-136.

2. DESCRIPTION

2.1 CONSTRUCTION

2.11 The Type CZC-46209 Radio Receiver is primarily designed for top of table or bench mounting. It is furnished in a metal cabinet supported from its mounting base

with rubber shock mounts at the four bottom corners of the cabinet. The front panel, to which the chassis is secured, forms the enclosure for one side of the cabinet. The general appearance and type of construction employed are shown in Figures 1 and 2.

2.12 The cabinet is of fabricated construction with ventilating louvers in its two sides and clearance apertures in the rear for access to the antenna and power input receptacles, fuses, and speaker connection terminals.

2.13 The chassis assembly is rigidly secured to the front panel. All component items, exclusive of those mounted on the front panel, entering into the construction of the Type CZC-46209 Radio Receiver, are mounted either on top or underneath the chassis structure. The chassis and front panel form a basic assembly capable of being inserted or withdrawn from the cabinet, as a unit.

2.14 When the chassis assembly is housed in the cabinet, it is secured to the cabinet by the front panel through the use of ten knurled, captivated type, thumb screws which pass through slots in the panel and engage with suitable inserts in the flanged sides of the front opening of the cabinet. The captivated type thumb screws are retained when loosened, in removable angles which also serve as "trim" for the front side corners of the cabinet, by concealing the mounting screw slots in the front panel. Two handles are conveniently arranged on the front panel to permit the insertion or removal of the chassis assembly without subjecting any of the operating controls to strain.

2.15 The construction of the chassis assembly and the arrangement and mounting of the component parts are clearly depicted in Figures 2.13 and 2.15. All vacuum tubes are accessible from the top side of the chassis upon removal of the chassis from the cabinet. The design and construction of the chassis assembly, and the arrangement of the component items mounted thereon, provides a high degree of accessibility to all items for inspection, servicing, or replacement. A bottom cover plate not shown in Figures 2.13 and 2.15, completely encloses the bottom of the chassis proper. It is provided as an added shielding feature, and for protection of the under side chassis mounted components against damage due to careless handling. It is secured to the chassis with machine screws so that it is readily removable, as and when necessary to make repairs or to effect replacement of chassis mounted components.

2.16 The receiver panel layout is shown in Figure 1, and the location and functions of the various controls are described in Section 5, Operating Instructions.

2.17 The Type CZC-46209 Radio Receiver is especially designed to minimize

radiation from the high frequency oscillator. This is accomplished by isolating the antenna input circuits from the first detector (or mixer) and the high frequency oscillator circuits, through the use of extensive shielding and filtering, and by the employment of a type of construction which reduces, to practical limits, undesirable circuit coupling by virtue of circulating currents in common shields.

2.18 A separate shielded compartment, designed as a complete sub-assembly and easily detachable, as such, from the chassis for inspection and servicing of the component parts which it houses, contains all the circuit elements between the antenna input and the signal grid of the R.F. amplifier tube. This sub-assembly, as pictured in Figures 2.13 and 2.15, is mounted at the rear center of the chassis, and is centrally disposed, above and below the chassis, through an aperture in the chassis. The compartment is grounded at only certain points on the chassis and since the mounting flanges are insulated from the chassis this ground constitutes the only grounding for the compartment. Details of the construction of the shielded compartment and the arrangement and mounting of the component parts, which it contains, are shown in Figure 2.18. The Figure depicts an oblique rear view of the shielded compartment with the side removed or opened to display the internal components. The compartment as pictured, is inverted with respect to its normal position in the receiver.

2.19 A second shielded compartment, constructed and mounted in the same manner as that containing the antenna circuit elements, but larger in overall dimensions, contains all of the circuit elements from the R.F. amplifier tube to the first I.F. amplifier input transformer, and includes also, all circuit elements associated with the high frequency oscillator. This compartment, as pictured in Figures 2.13 and 2.15, is mounted on the chassis between the front panel and the compartment containing the antenna input circuit elements. The arrangement and mounting of the circuit components are depicted in Fig. 2.19 which portrays an oblique view of the sub-assembly with the bottom cover plate removed to show the disposition of the internal circuit components. This view depicts the sub-assembly in an inverted position with respect to its normal position in the receiver. Circuit components, associated with the compartment sub-assembly, and not visible in Figure 2.19, are shown in Figure 2.13 which shows the two compartment sub-assemblies, described above, mounted in their normal positions, but with their top shield cover plates removed.

MODEL RCH RADIO RECEIVING EQUIPMENT

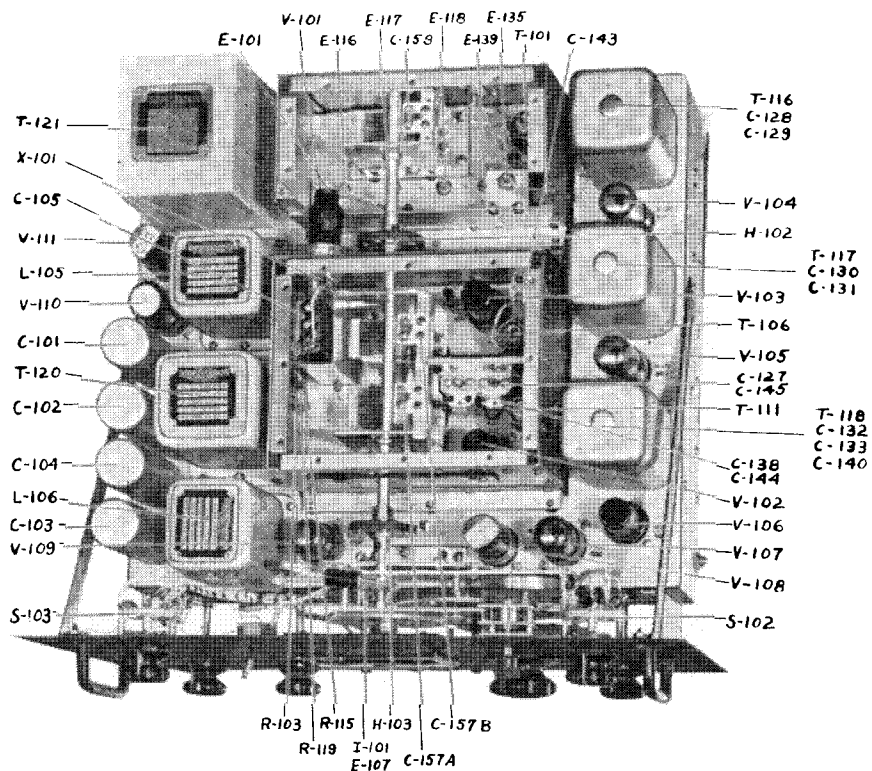

FIG. 2.13 TOP VIEW RADIO RECEIVER CHASSIS

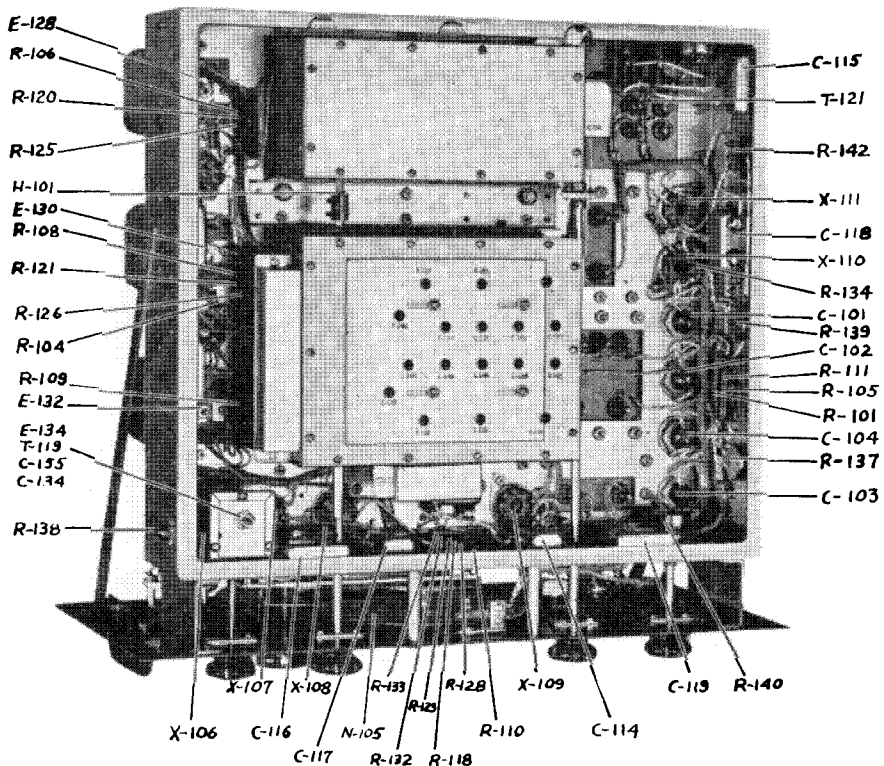

FIG. 2.15 RIGHT BOTTOM OBLIQUE VIEW, RADIO RECEIVER CHASSIS

MODEL RCH RADIO RECEIVING EQUIPMENT

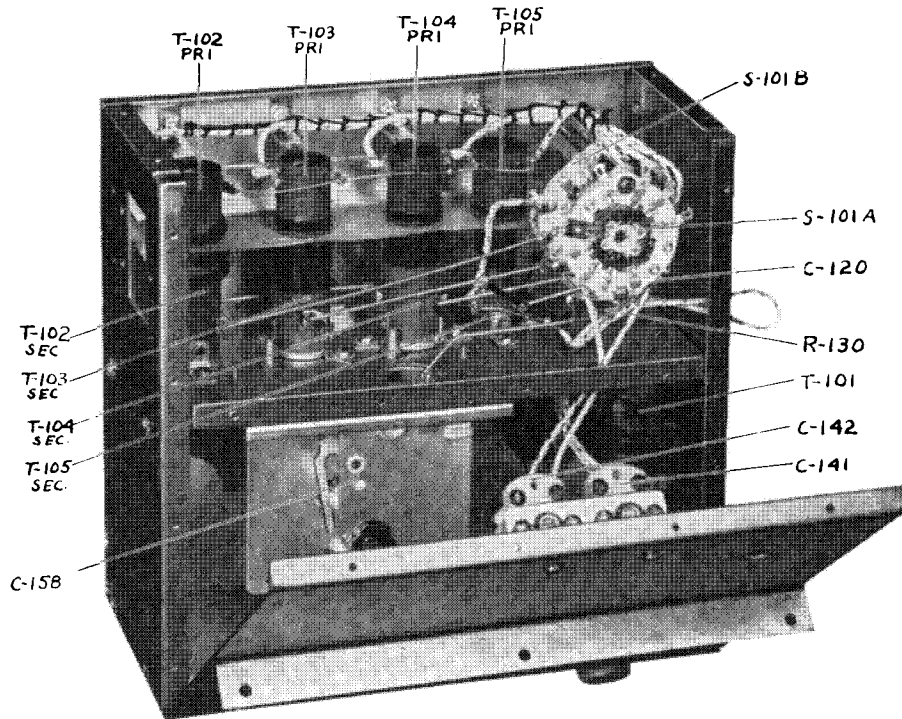

FIG. 2.18 LEFT OBLIQUE INVERTED VIEW, ANTENNA COMPARTMENT

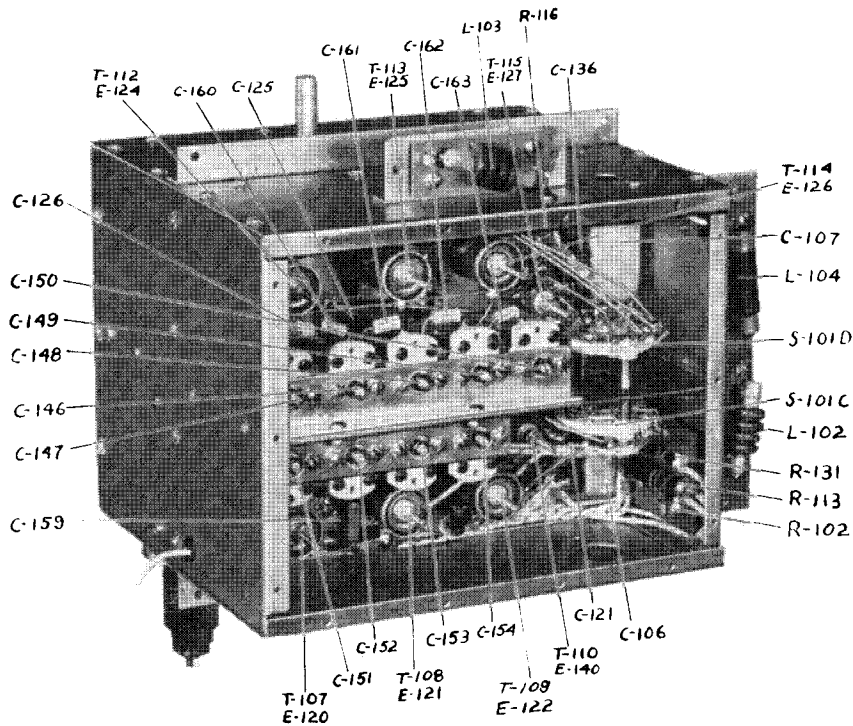

FIG. 2.19 BOTTOM OBLIQUE VIEW, R.F. AND H.F. OSC. COMPARTMENT

2.110 Insulated mechanical couplings are employed for joining together the shafts of the main tuning capacitors and the dial. These couplings are shown in Figure 2.13. The R.F. tube is mounted in a horizontal position in a socket which is provided with a clamp for securing the tube in place. The socket is mounted on one side wall of the large compartment and all wiring thereto is contained within the shielded compartment. The vacuum tube then projects into the side of the compartment containing the antenna circuit components, and connection to the signal grid cap is made within the confines of this compartment. The internal shields in the vacuum tube isolates the signal grid circuit from the plate circuit, and in effect completes the shielding of the antenna circuit compartment so that these circuits are electrically isolated from the plate circuit of the R.F. amplifier

tube, insofar as stray coupling from the high frequency oscillator is concerned.

2.111 Removable cover plates, secured with thumb screws, are provided on the two shielded compartments for access to the vacuum tubes contained within. Similar cover plates on the bottoms of the shielded compartments are secured with conventional machine screws. The top and bottom cover plates of the antenna shielded compartment must be removed for access to the circuit trimmers of this unit. The top cover plate of the osc.-mixer compartment must be removed for access to the circuit trimmers of Band No. 1 only. On all other frequency bands of the osc.-mixer compartment access to the circuit trimmers is afforded through openings in a sliding shield cover on the bottom of the compartment.

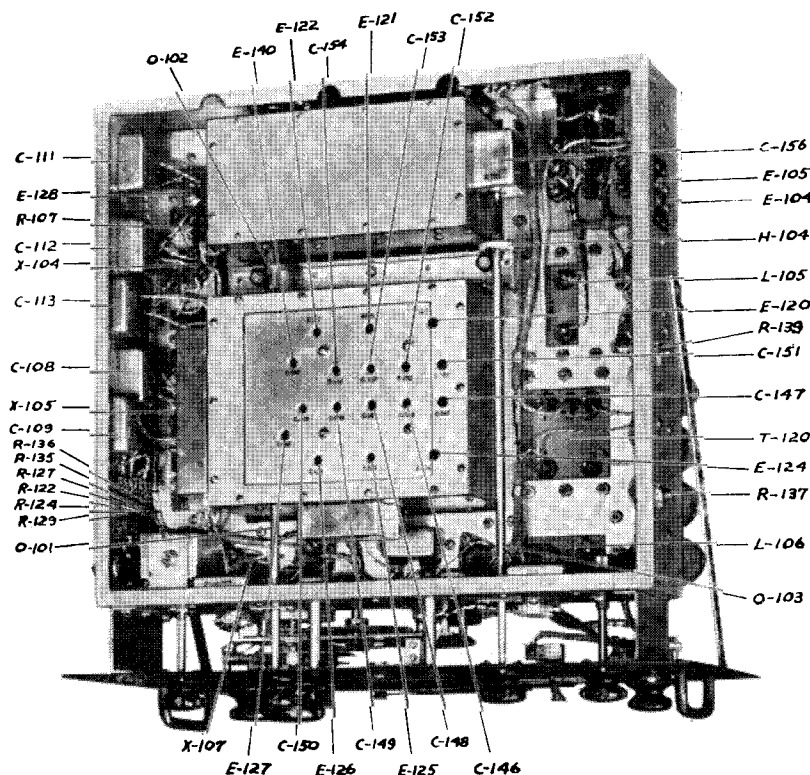

FIG. 2.111 LEFT BOTTOM OBLIQUE VIEW, RADIO RECEIVER CHASSIS

2.112 The secondary windings of the antenna coupling transformers feeding the grid of the R.F. amplifier tube are provided with individual adjustable iron cores for inductance trimming. For capacity trimming on Bands 1, 2 and 3, a variable air dielectric capacitor, adjustable from the front panel is provided. On bands 4 and 5, variable air dielectric capacitors are provided and are accessible for adjustment after removing the bottom cover of the antenna compartment. Access to the adjustable iron core inductance trimmers is provided upon the removal of the

top cover plate of the shielded compartment containing the antenna coupling transformers.

2.113 The R.F. transformers coupling the plate of the R.F. amplifier tube with the signal grid of the first detector, are each provided with both inductance trimmers in the form of adjustable iron cores and capacity trimmers in the form of variable air dielectric capacitors, for purposes of alignment, of these circuits, with the high frequency oscillator circuits. Access to these

trimmer components is afforded by the sliding bottom plate of the large unit containing the R.F. and H.F. oscillator components.

2.114 The high frequency oscillator circuits are similarly provided with adjustable air dielectric trimmer capacitors and adjustable iron cores for capacity and inductance trimming. These adjustable trimmers together with "Padder" capacitors, permit the tracking of the H.F. oscillator with the R.F. amplifier circuits. The padder capacitors on Bands 3, 4 and 5 are of the fixed, mica dielectric type. On Bands 1 and 2 an adjustable air dielectric capacitor is employed in parallel with the fixed mica dielectric capacitor. All trimmer adjustments on the bottom of this unit are accessible when the bottom cover plate is slid back to the open position. The trimmer adjustments on the top of the osc.-mixer compartment are accessible upon removal of the top cover plate of the unit.

2.115 The cabinet, front operating panel and mounting base of the Type CZC-46209 Radio Receiver have a standard black wrinkle finish. All metallic parts which enter into the construction of the chassis are finished with a suitable plating or paint to provide protection to these parts against corrosion.

2.2 CIRCUIT DESCRIPTION

2.21 GENERAL

2.211 The actual schematic diagram of the Type CZC-46209 Radio Receiver is shown in Figure 2.2. For purposes of illustration, it will be assumed that the circuits are set up as for reception on Band 1 as depicted in the circuit diagram 2.21. The following description will refer, therefore to the symbol numbers of the circuit elements of the band as, or when pertinent to the description. It shall be assumed that, unless otherwise noted, the description will apply to all other bands.

2.22 SIGNAL FREQUENCY CIRCUITS

2.221 Signal input to the receiver through antenna jack J-103 is connected to the primary winding of antenna input transformer T-101 by switch S-101A. An electrostatic shield at ground potential separates the secondary winding from the primary winding on Bands 2, 3, 4 and 5. The secondary winding of T-101 together with variable air dielectric capacitor C-158 and shunt connected capacitor C-156 constitutes the first tuned circuit. Capacitor C-156 is a variable air dielectric capacitor, and is controlled from the front operating panel by the knob marked "ANT. TRIMMER". This capacitor is connected in the circuit only on Bands 1,

2 and 3. On Bands 4 and 5 the circuits are aligned by adjustable air dielectric trimmers C-141 and C-142, which are located inside of the antenna shield compartment. Transfer of R.F. signal at the resonant frequency of this tuned circuit, from the antenna to the control grid of R.F. amplifier tube V-101, is accomplished by inductive coupling through antenna input transformer T-101. Variable capacitor C-158 is ganged with variable capacitors C-157A and C-157B to provide uncontrolled tuning of the receiver. The secondary winding of transformer T-101 is provided with adjustable iron core E-115 for inductance trimming and variable air dielectric trimmer capacitor C-156 for capacity trimming as stated above. These trimmer elements permit the accurate alignment of the tuned circuits at both ends of the frequency band. The high potential end of the tuned circuit is connected to the control grid of R.F. amplifier tube V-101, by switch S-101B and through coupling capacitor C-120. The low potential end of the tuned circuit is returned to ground. The d-c bias return from the control grid of R.F. amplifier tube V-101 to the AVC bus is closed through grid resistor R-130. Inductor L-101 is connected in the primary circuit of the antenna coupling transformer and is provided to attenuate signals of the I.F. frequency. This inductor is tuned by fixed capacitor C-135 and adjusted to resonance by adjustable iron core E-135.

2.222 Plate potential from the high voltage d-c bus is applied to the plate of R.F. amplifier tube V-101, through decoupling filter resistor R-115, bypassed to ground by capacitor C-105B and capacitor C-159. The suppressor is connected to the screen which is operated at high potential. Initial bias is obtained by means of cathode resistor R-103 and SENSITIVITY control potentiometer R-140B, the cathode is bypassed by capacitor C-105A. Screen potential, also obtained from the high voltage d-c bus, is applied to the screen through a decoupling filter resistor R-119 and bypass capacitor C-105C.

2.223 The amplified signal voltage from the plate of R.F. amplifier tube V-101 is applied to the primary winding of R.F. transformer T-106, and by inductive coupling is transferred to the control grid of first detector tube V-103 through the secondary winding of R.F. transformer T-106, switch section S-101C and coupling capacitor C-121. The secondary winding of transformer T-106, together with the variable air dielectric tuning capacitor C-157B, constitute the second and final tuned circuit operating at the signal frequency. The low potential end of the secondary winding of transformer T-106 connects to ground. Adjustable iron core E-119 and parallel connected variable air dielectric

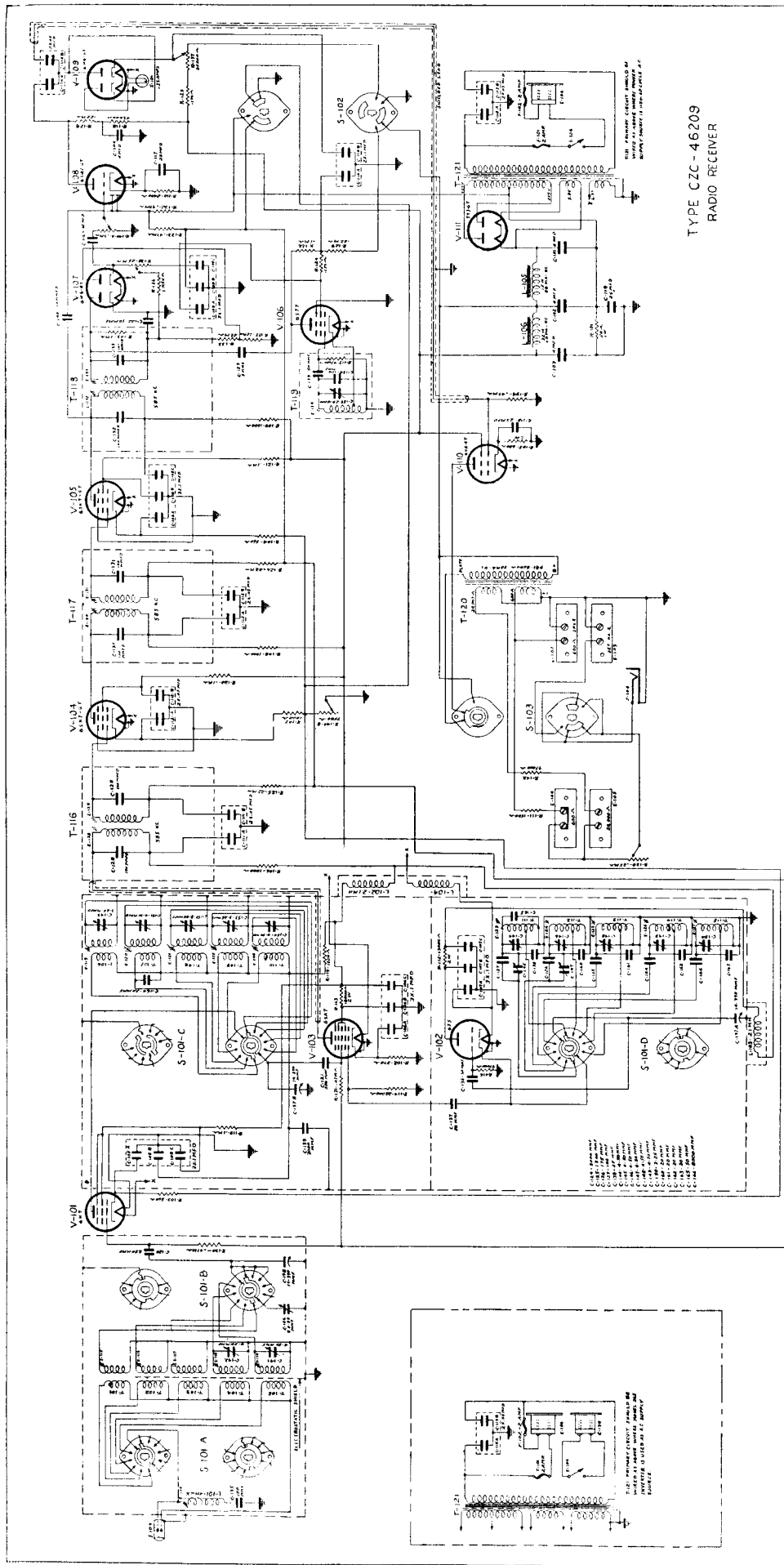
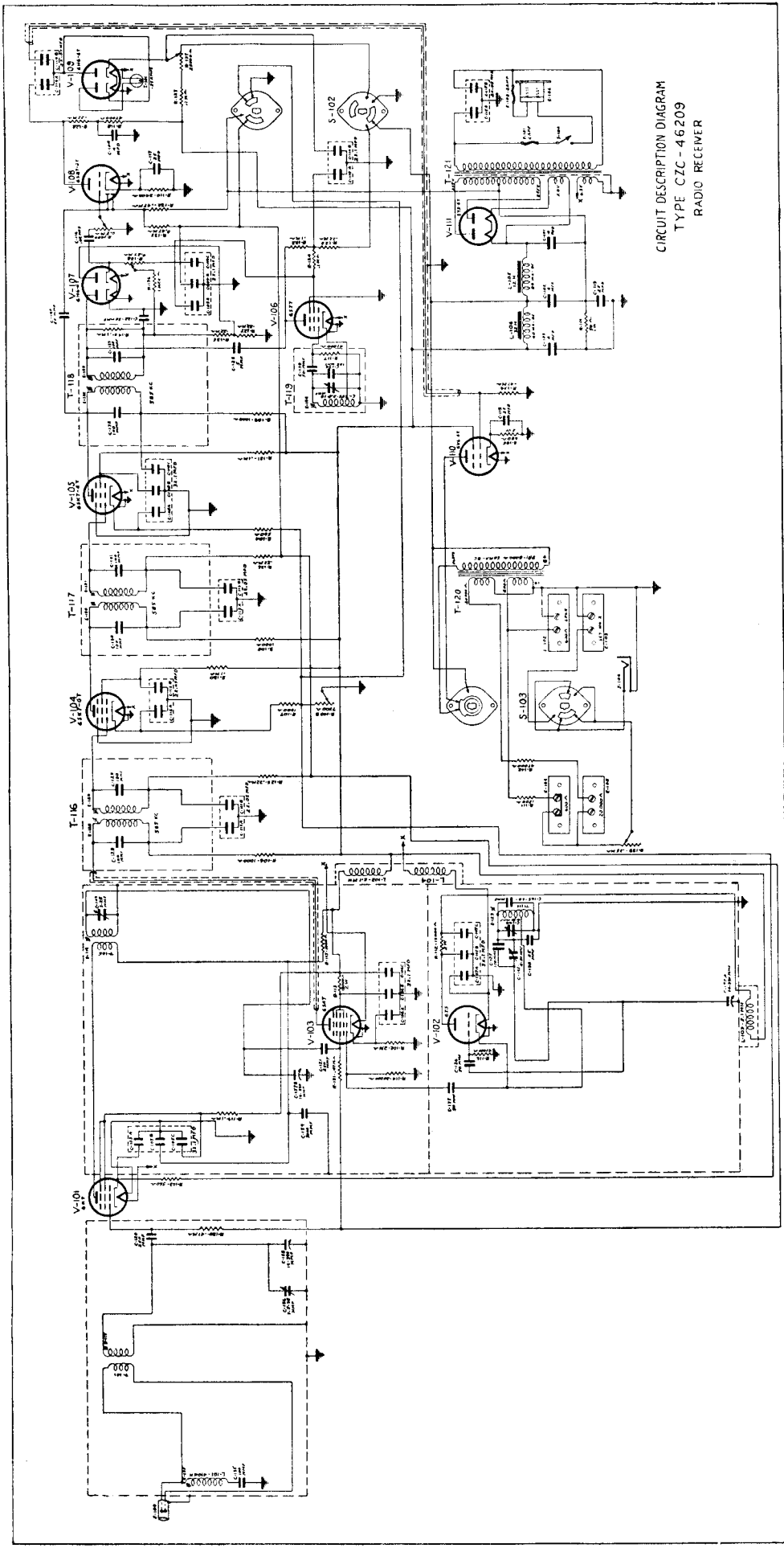

FIG. 2.2 ACTUAL SCHEMATIC DIAGRAM, TYPE CZC-46209 RADIO RECEIVER



CIRCUIT DESCRIPTION DIAGRAM
 TYPE CZC - 46209
 RADIO RECEIVER

FIG. 2.21 SCHEMATIC DIAGRAM OF CIRCUIT DESCRIPTION

capacitor C-143, are provided for alignment purposes and are accessible for adjustment as described in Par. 2.111. The d-c bias return from the control grid of first detector tube V-103 to the AVC bus is closed through grid resistor R-131.

2.224 Screen potential from the high voltage d-c bus is applied to the screen of first detector tube V-103 through R.F. inductor L-102 bypassed to ground by capacitor C-106C and through decoupling filter resistor R-113, bypassed to ground by capacitor C-106B. The suppressor is internally connected to the shell of the tube. Initial bias is obtained by means of cathode resistor R-102, bypassed to ground by capacitor C-106A.

2.23 HIGH FREQUENCY OSCILLATOR CIRCUITS

2.231 The high frequency oscillator is of the so called "electron coupled" type. The tuned circuit consists of tapped inductor T-111 shunted with variable air dielectric trimmer capacitor C-144 and tuned with variable air dielectric tuning capacitor C-157A, fixed padder capacitor C-127 and variable air dielectric padder capacitor C-145. The inductor element is also provided with adjustable iron core E-123 for inductance trimming. Padder capacitors C-127 and C-145 are used to modify the tuning of the H.F. oscillator so that it will maintain a fixed frequency difference of 585 kilocycles with respect to the signal frequency when tuning capacitors C-158, C-157A and C-157B are varied from minimum to maximum capacity. Inductor T-111 is compensated for variations in temperature by capacitor C-138 which has a negative temperature coefficient. The high potential end of the oscillator tuned circuit is connected, by switch S-101D, through coupling capacitor C-136 to the control grid of the H.F. oscillator tube V-102. This grid is returned to ground through grid resistor R-116 for d-c bias return. The low potential end of the tuned circuit is also returned to ground. The cathode of H.F. oscillator tube V-102 is connected by switch S-101D, to the tap on inductor T-111 and through coupling capacitor C-137 to the injector grid of first detector tube V-103. This grid has a d-c return to ground through grid resistor R-114.

2.232 The plate of H.F. oscillator tube V-102 is connected to the high voltage d-c bus through decoupling filter resistor R-112, bypassed to ground by capacitor C-107B, and R.F. filter inductor L-103, bypassed to ground by capacitor C-107C. One side of the heater circuit operates at ground potential while the other side is filtered by capacitor C107A and R.F. filter inductor L-104.

2.24 I.F. AMPLIFIER CIRCUITS

2.241 The signal frequency arriving at the control grid of first detector tube V-103 and the H.F. oscillator frequency arriving at the injector grid of this tube, are mixed (or heterodyned) and the resultant difference frequency (585 kilocycles) is fed to the input of the intermediate frequency amplifier.

2.242 Transfer of intermediate frequency energy, from the first detector tube V-103 to second detector tube V-107 is accomplished by inductive coupling through I.F. transformers T-116, T-117 and T-118 and amplified through I.F. amplifier tubes V-104 and V-105. First I.F. transformer T-116 consists of two tuned circuits, the primary and secondary windings are tuned to the intermediate frequency of 585 kilocycles by fixed capacitors C-128 and C-129 and by adjustable iron cores E-128 and E-129, provided for inductance trimming and accessible through the top and bottom of the transformer shield cans. The high potential end of the primary tuned circuit connects to the plate of first detector tube V-103 through a shielded conductor, while the low potential end of the winding connects to the high voltage d-c bus through decoupling filter resistor R-106, bypassed to ground by capacitor C-111A. The high potential end of the secondary tuned circuit is connected to the grid of first I.F. amplifier tube V-104 while the low potential end is connected to the AVC bus through filter resistor R-125 bypassed by capacitor C-111B.

2.243 Screen potential from the high voltage d-c bus is applied to the screen of first I.F. amplifier tube V-104 through decoupling filter resistor R-120, bypassed to ground by capacitor C-112B. Minimum bias is obtained through resistor R-107, bypassed by capacitor C-112A.

2.244 Second I.F. transformer T-117 is identical to first I.F. transformer T-116, with respect to its design and construction. Accordingly, except for differences in circuit symbol designations which becomes obvious upon examination of Figure 2.2 the circuit description of paragraph 2.242 is applicable to this transformer in all details.

2.245 The circuit arrangement of second I.F. amplifier tube V-105 is the same, except for symbol designations as described for first I.F. amplifier tube V-104, in paragraph 2.243 above.

2.246 Third I.F. transformer T-118 is identical in design and construction to second I.F. transformer T-117 except for the coupling between the primary and secondary

windings. Accordingly, except for differences in circuit symbol designations, the circuit description of paragraph 2.242 is applicable to this transformer.

2.25 SECOND DETECTOR CIRCUITS

2.251 Second Detector tube V-107 is a twin diode tube, one section of which is used as a second detector. The plate of this diode is connected to the high potential end of the secondary winding of transformer T-118. The cathode is grounded, thus the tube acts as a half wave rectifier. The other section of the twin diode tube is used in a peak noise limiter circuit. A variable potentiometer R-138 is provided to adjust the threshold level at which the noise limiter will work. This control has a screwdriver slot in the shaft and is accessible through an opening in the right side of the cabinet.

2.26 C.W. OSCILLATOR CIRCUITS

2.261 Associated with the second detector circuits is the C.W. oscillator tube V-106. The C.W. oscillator circuit normally operates at the I.F. frequency 585 kilocycles. It provides an R.F. potential with which an unmodulated I.F. signal at the second detector can heterodyne to produce an audible beat note and is intended for the reception of C.W. signals. The frequency of the C.W. oscillator circuit is determined by inductor T-119, parallel connected capacitor C-134 and adjustable iron core E-134. Capacitor C-134 is a temperature compensating type and is used to keep the C.W. oscillator circuit stable with temperature variations, this capacitor has a positive temperature coefficient. The circuit of the C.W. oscillator is of the electron coupled type. A variable air dielectric capacitor C-155 is connected across inductor T-119 and is controlled by knob E-111 from the front operating panel, this capacitor is used to control the frequency of the C.W. oscillator within narrow limits. Potential from the C.W. oscillator tube V-106 is coupled, by means of fixed capacitor C-123 to the second detector diode plate of tube V-107. Plate potential is applied to the plate of C.W. oscillator tube V-106, through resistor R-122 and filter resistor R-129, bypassed to ground by capacitor C-110A. Screen potential is applied to this tube through filter resistor R-124, bypassed by capacitor C-109A.

2.27 AUTOMATIC VOLUME CONTROL CIRCUITS

2.271 Automatic volume control is provided by the diode section of tube V-108. I.F. potential from the plate of second I.F. amplifier tube V-105 is applied to the diode plates of V-108 through fixed capacitor C-140. This R.F. potential is rectified by the diode and the voltage appearing across load resistor

R-132 is filtered by resistor R-133 and capacitor C-109B and the resultant d-c potential is used to control the gain of amplifier tubes V-101, V-103, V-104 and V-105, the degree of control being dependent on the strength of the incoming signal. This AVC voltage is applied to the tubes only when the RECEPTION switch on the front operating panel is set in the MOD position. Delay voltage is applied to the AVC bus by applying a negative 3 volt potential to the low potential end of resistor R-132, this delay voltage is applied so that the AVC will not become effective until a signal strong enough to develop approximately 3 volts across the diode load resistor R-132, is applied to the plates of the diode section of tube V-108.

2.28 A.F. AMPLIFIER CIRCUITS

2.281 The audio voltage developed across the diode load resistor R-127 as the result of the demodulating action of the second detector tube V-107, is applied to the control grid of first A.F. amplifier tube V-108, through coupling capacitor C-116 and VOLUME control potentiometer R-140A.

2.282 Amplification of the A.F. signals from the second detector is accomplished by resistance-capacity coupling between the first A.F. amplifier tube V-108 and the second A.F. output amplifier tube V-110. Twin diode tube V-109 is provided as an audio output limiter and is connected in the audio circuit between V-108 and V-110, it is effective only when the RECEPTION switch on the front panel is in the C.W.O.L. position. Since the AVC system of the receiver is not functioning when in the C.W.O.L. operating position, a C.W. signal which is fading considerably, will give a great variation in audio output, the output limiter circuit acts to level off the peaks of the fading signals thus providing a more constant audio output at the phone jack or speaker terminals. A variable potentiometer R-137 is provided to adjust the level at which the output limiter circuit will work, this control is of the screwdriver adjustment type and is accessible for adjustment through an aperture in the left side of the receiver cabinet.

2.283 Transfer of audio frequency energy, from the plate of output amplifier tube V-110 to head telephone jack J-104 and speaker terminals E-102, is accomplished through output transformer T-120. This transformer has two secondary windings, one of 600 ohms impedance and the other of 20,000 ohms impedance. The speaker terminals E-102 are connected permanently to the 600 ohm winding and the head phone jack J-104 can be matched to either winding by means of two link strips on the left side of the receiver chassis.

2.29 RECEPTION SWITCH CIRCUITS

2.291 The RECEPTION switch S-102, mounted on the front panel of the Type CZC-46209 Radio Receiver provides the following circuit conditions:

2.2911 "MOD" position: The R.F. gain control R-140B is shorted out so that the R.F. gain is maximum at all times. The AVC circuit is operating. Potential from the high voltage d-c bus is removed from the C.W. oscillator tube V-106 so that this circuit is not operating. Maximum bias is applied to the cathode of the output limiter tube V-109 through resistor R-123 and variable potentiometer R-137, from the high voltage d-c bus so that this circuit does not operate.

2.2912 "C.W." position: The R.F. gain control R-140B is connected in the circuit and controls the bias on V-101, V-104 and V-105, thus controlling the gain of these tubes. The AVC is shorted out so that it does not operate and minus 3 volts is applied directly to the AVC bus. Potential from the high voltage d-c bus is applied to the C.W. oscillator circuit so that this circuit operates. The Output limiter tube V-109 does not operate.

2.2913 "CWOL" position: The R.F. gain control R-140B, AVC circuit and C.W. oscillator circuit are connected as in paragraph 2.2912 above. Variable potentiometer R-137 in the output limiter circuit is grounded at one end and the bias on the cathode of V-109 can be adjusted so that the output level can be set to suit the operator.

2.210 PHONE CONTROL CIRCUITS

2.2101 The PHONE CONTROL switch S-103, mounted on the front panel of the Type CZC-46209 Radio Receiver provides the following circuit conditions:

2.2102 Position "NO. 1" provides for connecting the headphone jack J-104 to the output transformer of the Type CZC-46209 Receiver through a variable resistor R-139, terminal link strips E-104, E-105 and resistors R-111 and R-142. Terminal E-104, marked 600 ohms and terminal E-105, marked 20,000 ohms, are provided so that the phone jack output can be matched to output transformer T-120 for the use of either 600 ohm or 20,000 ohm head phones. The shorting link should be placed across the proper terminal board to match the impedance of the head phones being used. Resistors R-111 and R-142 are used to cut the audio output available at the phone jack to approximately 100 milliwatts. The output at the

phone jack can be adjusted from 100 milliwatts to approximately 1 milliwatt by means of variable resistor R-139 which is of the screwdriver adjusting type and is accessible for adjustment through an opening in the left side of the receiver cabinet.

2.2103 The "MIXED" position provides for connecting the phone jack J-104 to the audio circuit as outlined in paragraph 2.2102 above, and in addition it also connects the phone jack to terminal board E-103, mounted in the rear of the receiver chassis. This terminal board is provided for connection to a second receiver so that in the MIXED position, the output of both receivers are heard simultaneously.

2.2104 Position "No. 3" provides for connecting the phone jack J-104 to the output of the second receiver only.

2.211 RECTIFIER POWER CIRCUITS

2.2111 The proper a-c heater potential for all vacuum tubes except the rectifier is obtained from one secondary winding of the power transformer T-121, one side of this secondary is operated at ground potential. Filament potential for the rectifier tube V-111 is obtained from a second winding of this transformer. High voltage a-c plate potential from a third winding of transformer T-121, is applied to the plates of rectifier tube V-111. The rectified pulsating potential is obtained from the filament of this tube and fed through a two section filter consisting of inductors L-105, L-106 and capacitors C-101, C-102, C-103, and thence to the high voltage d-c bus. The center tap of the high voltage winding is returned to ground through Resistor R-101 which provides a negative 3 volts which is utilized for delay bias on the AVC bus.

2.2112 The a-c power input line to the primary winding of power transformer T-121 is filtered by capacitors C-115A and C-115B to prevent stray R.F. potentials from being applied across the primary winding. THE PRIMARY WINDING IS FUSED BY F-101 AND F-102 WHICH SHOULD NEVER BE REPLACED WITH FUSES OF HIGHER RATING THAN 2 AMPS.

2.3 PERFORMANCE DATA

2.31 The SENSITIVITY vs. FREQUENCY curves are plotted in Plate 1 and are representative of the overall sensitivity of the Type CZC-46209 Radio Receiver over the five bands covered by the Receiver. These curves together with the OVERALL SELECTIVITY curves shown in Plate 2, provide data for definitely checking the Type CZC-46209 Radio Receiver to determine if repairs or realignment are necessary, since

the majority of circuit element failures or any misalignment will reduce the sensitivity of the equipment. The data referred to above will, therefore, also serve to show the efficacy of repairs or realignment.

2.32 The selectivity of a radio receiver is that characteristic which determines the extent to which it is capable of differentiating between the desired signal and disturbances of other frequencies. The OVERALL SELECTIVITY curves of Plate 2, are representative of the overall selectivity characteristics of the Type CZC-46209 Radio Receiver.

2.33 The image attenuation is the degree to which a superheterodyne type of radio receiving equipment is capable of rejecting signals off resonance which, in combination with the fundamentals or any harmonic of the conversion oscillator, produce intermediate frequencies which are amplified by the intermediate frequency amplifier and result in spurious responses. The IMAGE ATTENUATION vs. DESIRED SIGNAL FREQUENCY curves of Plate 3, show the extent to which the Model RCH Radio Receiving Equipment is capable of rejecting image responses. The curves of Plate 3, are representative of the extent to which primary image frequencies are attenuated by the preselector tuned circuits of the Type

CZC-46209 Radio Receiver. The primary image frequency is equal to the desired signal frequency plus two times the intermediate frequency. The attenuation of the primary image, corresponding to any desired signal frequency as derived from the curves of Plate 3, is predicated on the ratio between the r-f inputs, at the desired signal and primary image frequencies, to produce a constant output as measured with the receiver tuned for resonance with the desired signal frequency.

2.34 The AVC, and OVERALL FIDELITY characteristics shown on Plate 4 and 5 are necessary when particular performance checks are desired, but are of secondary importance in most cases in the determination of the necessity for repairs or realignment.

2.35 The maximum undistorted power output, as measured at 400 cycles across a pure resistance load of 600 ohms at the speaker terminals E-102, is approximately 2 watts.

2.36 The high frequency oscillator radiation, as measured at the antenna input terminals of the Type CZC-46209 Radio Receiver, is less than 400 micro-microwatts at any frequency covered by the Model RCH Radio Receiving Equipment. This characteristic will permit "safe" operation of the equipment on Naval vessels.

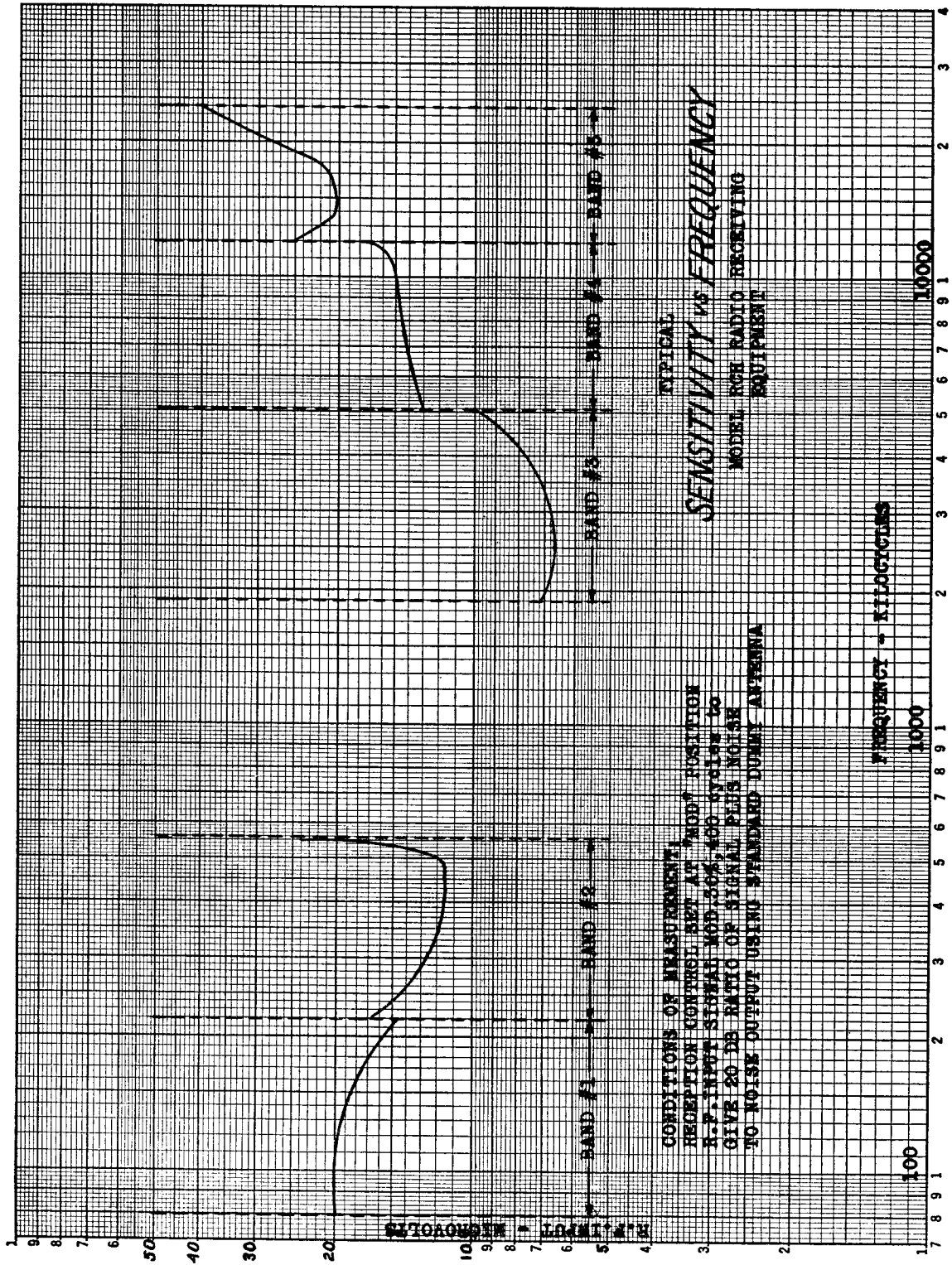

CONDITIONS OF MEASUREMENT:
 RECEPTION CONTROL SET AT "MODE" POSITION
 R.F. INPUT SIGNAL MOD. 50%, 400 CYCLES TO
 GIVE 20 DB RATIO OF SIGNAL PLUS NOISE
 TO NOISE OUTPUT USING STANDARD DUMMY ANTENNA

TYPICAL
SENSITIVITY vs FREQUENCY
 MODEL RCH RADIO RECEIVING
 EQUIPMENT

PLATE 1

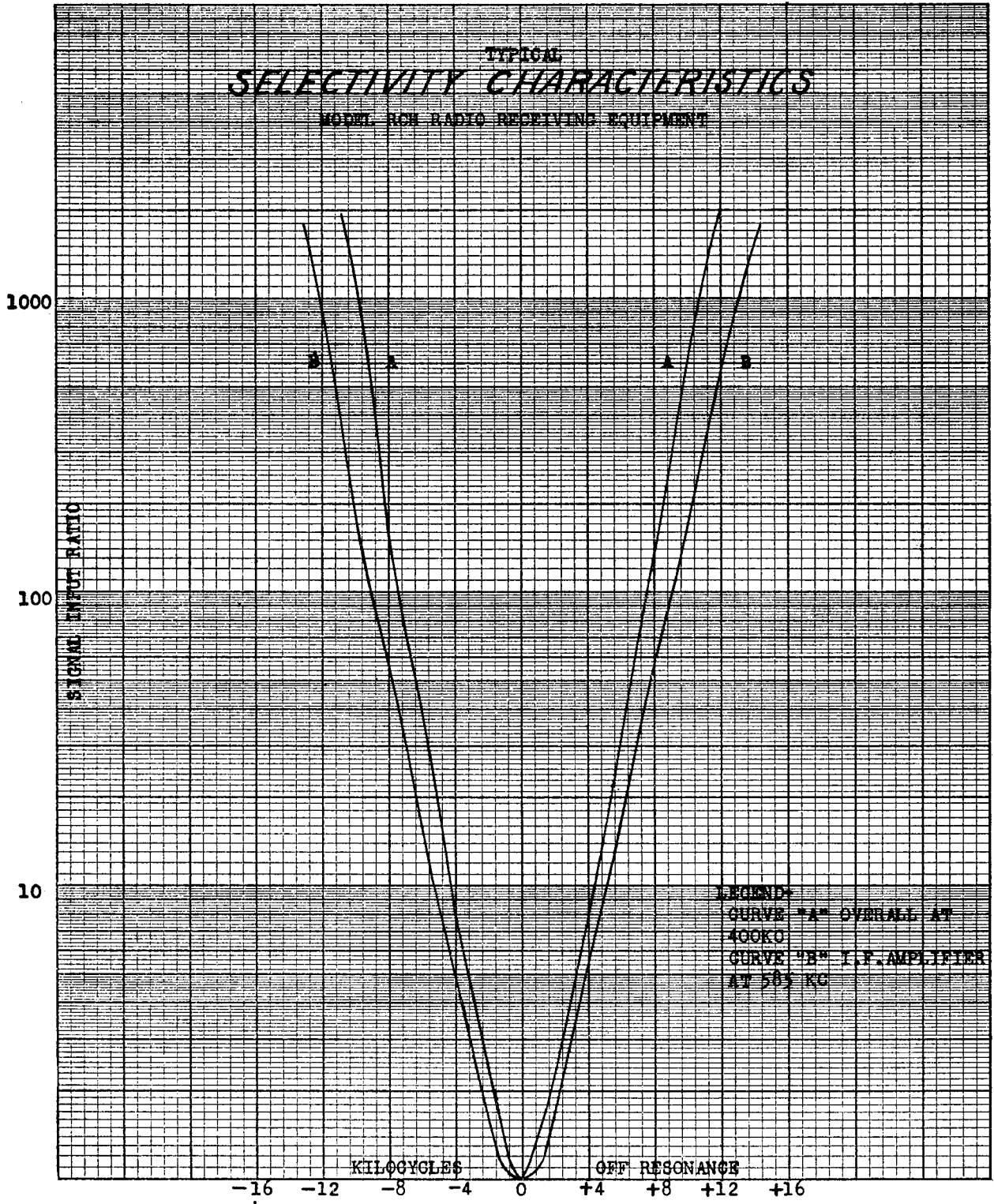

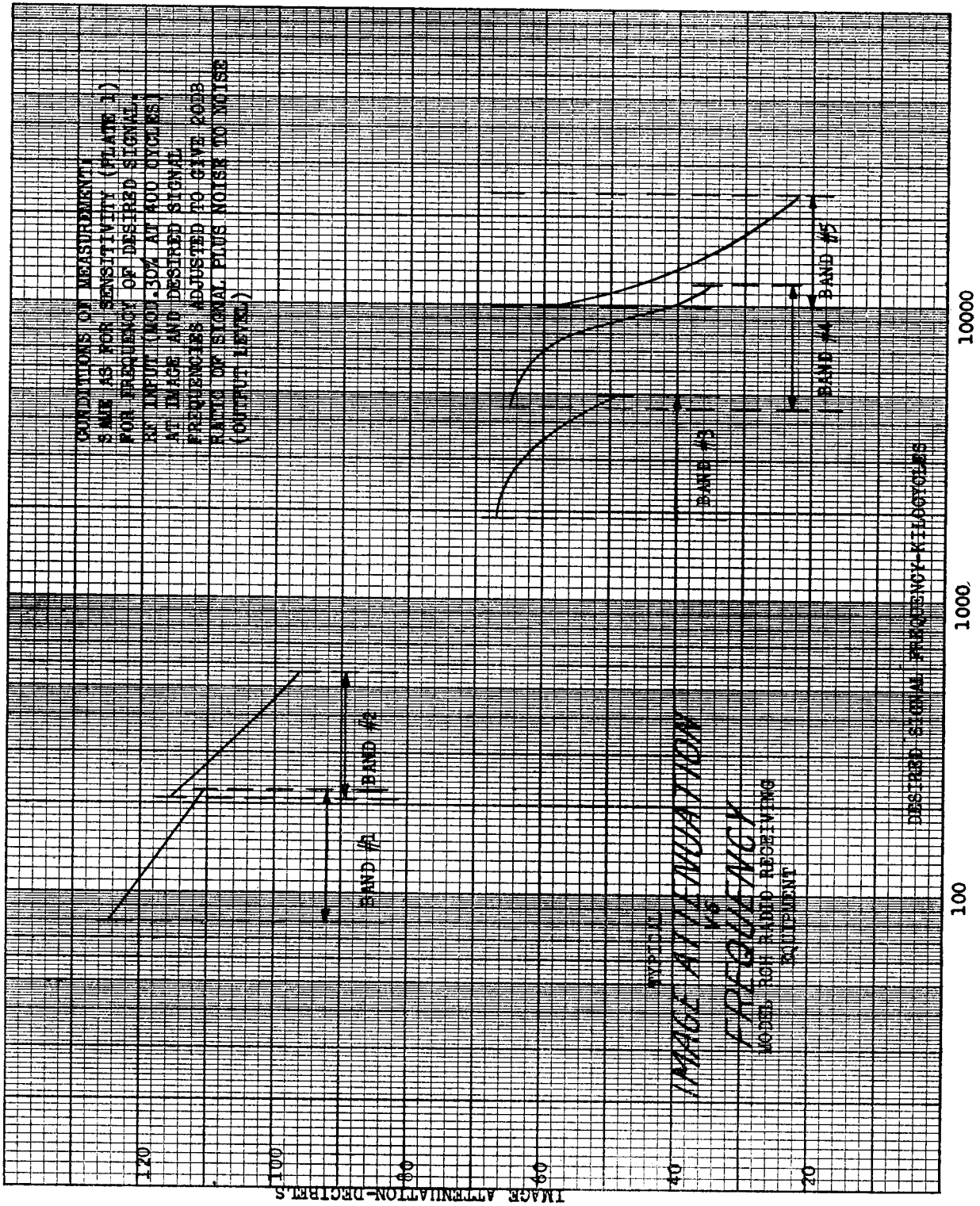

PLATE 3

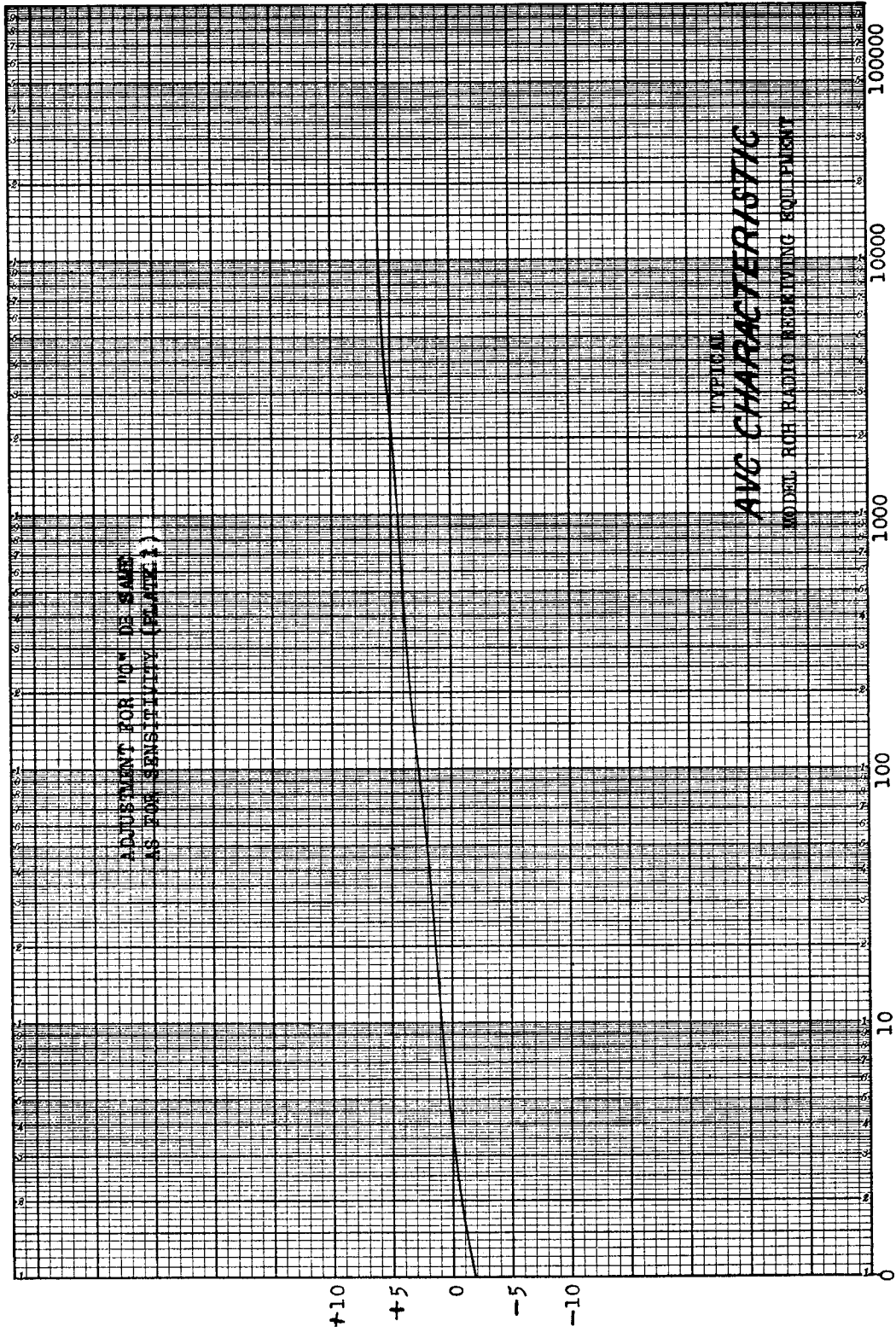

PLATE 4

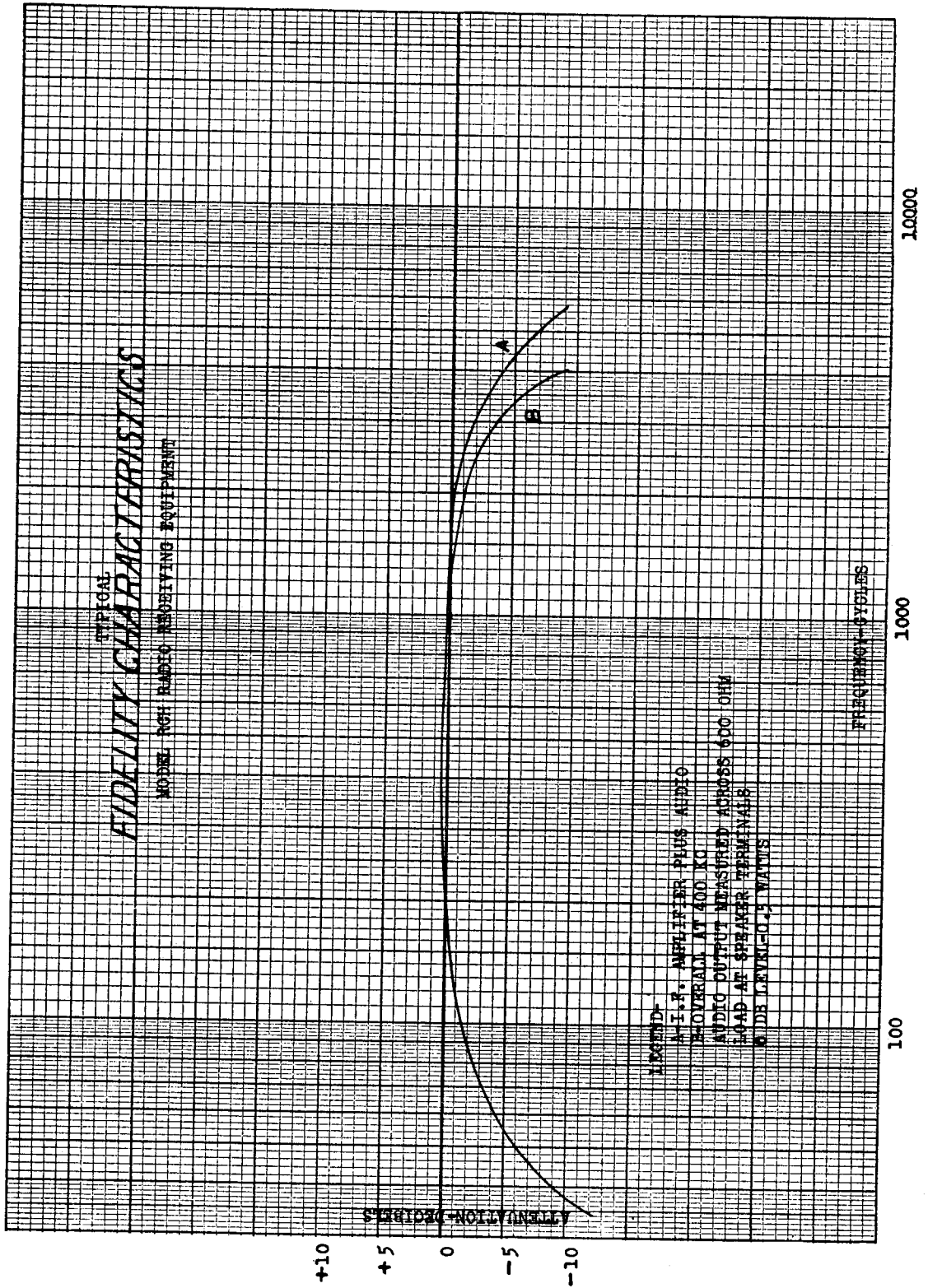

PLATE 5

3. INSTALLATION

3.1 The Model RCH Equipment, with its Type CZC-46209 Radio Receiver equipped with one full complement of vacuum tubes, One Navy Type -49121A concentric antenna-ground connecting plug, and one female power input plug, is shipped in a single wooden packing box. Two instruction books and one set of spare parts, which include one set of spare vacuum tubes, and two pair of Navy Type -49016 headphones are also contained in the same packing box.

3.2 After unpacking the equipment it should be inspected for any possible damage that might have resulted from careless handling in transit. Make certain that all vacuum tubes are firmly seated in their respective sockets. Inspection of the chassis and vacuum tubes may be readily effected upon the removal of the chassis from its cabinet. This is accomplished by loosening the thumb screws on the front panel and removing the two retaining plates at either side of the front operating panel. Then remove the two retaining screws at the rear of the chassis. The chassis can then be withdrawn from the cabinet by pulling on the two handles on the front panel. The two retaining screws in the rear of the cabinet may be left out when the receiver is permanently installed to facilitate removal of the receiver from the cabinet for servicing or inspection.

3.3 The mounting base to which the shock mountings for the receiver are attached, is drilled with four holes through which three eighth inch bolts of the proper length may be

passed to fasten the receiver permanently to a table or bench

3.4 In planning an installation, care should be exercised to provide adequate clearance from the back of the Type CZC-46209 Radio Receiver to the bulkhead or nearest obstruction in order to provide access to the power input plug, the antenna ground concentric plug, speaker output terminals, and fuses, or the movement of feeder cables when withdrawing the chassis from the cabinet for servicing, vacuum tube replacement, or inspection.

3.5 Make connection to the proper 110/125 volt, 58/62 cycle, single phase, a-c power source by means of a suitable, two conductor, shielded cable for connecting the power source with plug P-102 which is then inserted in receptacle E-106 at the rear of the receiver chassis.

3.6 Make antenna connections in accordance with Par. 1.5, Antenna Requirements. The antenna lead, or shielded patch cable should be soldered to concentric plug P-101 in accordance with previously described methods.

3.7 Terminals are provided on the rear of the receiver chassis for connection of a permanent type loudspeaker, which should be provided with a matching transformer having a primary impedance of 600 ohms. If no speaker is used a 600 ohm load resistor must be connected across the 600 ohm speaker terminals E-102.

4. ALIGNMENT DATA

4.1 GENERAL

4.11 Should realignment of the Type CZC-46209 Radio Receiver become necessary, the following alignment data should be carefully studied before making any adjustments. It is important that the operator understand the functions of each circuit element so that correct alignment may be obtained quickly and accurately. The alignment data of this section is, therefore, supplemented by Par. 2.1, Construction and Par. 2.2, Circuit Description.

4.12 Performance Data and Test Data presented in Par. 2.3 and 6.4 will be particularly helpful in determining the necessity for making any specific adjustments. The operator is cautioned against making any adjustments indiscriminately and he should not realign any circuit unless tests definitely indicate realignment is necessary.

4.13 All alignment and calibration tests, measurements, etc., may be made with

the Model LP Standard Signal Generator, or similar equipment, and an output meter, General Radio Type 583A, or equivalent. All tests are made with the Standard Signal Generator adjusted to provide a test signal having 400 cycle, 30% modulation, unless otherwise specified.

4.14 Before proceeding with the alignment of any circuit of the Type CZC-46209 Radio Receiver, the Receiver must be removed from the cabinet, the bottom cover plate of the chassis, top cover plates of both antenna and osc.-mixer, units and the bottom shield plate of the antenna unit, must be removed. Access to the trimmer components in the bottom section of the osc.-mixer compartment is provided by means of a sliding plate on the bottom shield.

4.15 The Type CZC-46209 Radio Receiver must be connected to a 115 volt, 60 cycle single phase, a-c source. The power switch S-104 to ON. The BAND CHANGE

switch to position 1 and the GAIN control set at 10. An output meter, General Radio Type 583A, or equivalent, connected across a pure resistance load of 600 ohms, should be connected across the speaker terminals E-102.

4.16 The complete alignment of the Type CZC-46209 Radio Receiver may be divided into four steps:

- (1) Intermediate frequency amplifier alignment.
- (2) High frequency oscillator alignment.
- (3) Radio frequency amplifier alignment.
- (4) Tracking of H.F. oscillator and R.F. amplifier circuits.

NOTE: THE CIRCUITS MUST BE CHECKED IN THE ABOVE ORDER WHEN COMPLETE ALIGNMENT IS NECESSARY.

4.2 I.F. AMPLIFIER ALIGNMENT

4.21 The intermediate frequency of the Type CZC-46209 Radio Receiver is 585 kilocycles, plus or minus 1 kilocycle.

4.22 Tuning adjustments are provided in each I.F. transformer. These adjustments consist of adjustable iron cores and are designated by symbol numbers E-128 to E-133 inclusive, as indicated on circuit diagram Figure 2.2.

4.23 The high output lead of the Standard Signal Generator should be connected to the stator lug on the top of the mixer tuning capacitor C-157B and the ground lead to any metal part of the chassis.

4.24 The frequency of the Signal Generator should be carefully adjusted to 585 kilocycles and the signal input to tube V-103 adjusted to provide a reading on the output meter, with the GAIN control of the Receiver fully advanced. The I.F. tuning adjustments listed in paragraph 4.22 should each be carefully adjusted to give a maximum reading on the output meter. The adjustments should be made starting with the third I.F. transformer and working back to the first I.F. transformer. While making these adjustments it may be necessary to reduce the signal input to the Receiver in order to avoid overload in the second detector or audio circuits. Such overload will make the I.F. trimmer adjustments appear to be considerably less critical than they actually are and may, in extreme cases, indicate incorrect peak adjustments. To be safe, the audio output at the speaker terminals should not exceed 0.5 watts.

4.25 The performance of the I.F. amplifier and audio circuits can be checked

against the stage gain Data in Section 6, paragraph 6.51, after alignment has been completed. Similarly, the selectivity may be checked against the data in Section 2, Plate 2.

4.26 After alignment of the I.F. amplifier has been checked and found to be correct, the C.W. oscillator tube V-106 should be inserted in its socket, the C.W. oscillator control knob set to zero and iron core adjustment E-134 adjusted so that the frequency of the C.W. oscillator zero beats with the 585 kilocycle signal from the Signal Generator. The modulation of the Signal Generator should be turned off for this adjustment.

4.3 HIGH FREQUENCY OSCILLATOR ALIGNMENT

4.31 The need for realignment of the high frequency oscillator circuit is indicated if the dial calibration is in error by more than 1%.

WARNING: READJUSTMENT OF THE H.F. OSCILLATOR CIRCUIT TRIMMERS SHOULD NOT BE ATTEMPTED UNTIL AFTER THE NEED FOR SUCH READJUSTMENTS HAS BEEN POSITIVELY ESTABLISHED BY TESTS COVERED IN SECTION 6.

4.32 To check the operation of the R.F. amplifier and H.F. oscillator circuits, the Signal Generator should be connected to the antenna input jack J-103, using a standard dummy antenna. The RECEPTION control must be set in the "MOD" position and a 400 cycle, 30% modulated signal fed into the receiver from the Signal Generator. The GAIN control may be retarded somewhat if desired, as the background noise may be excessive when the control is fully advanced.

4.33 It is particularly important that the H.F. oscillator circuits operate at a higher frequency than that of the R.F. amplifier circuits. This can be checked by tuning in the image of the test signal from the Signal Generator. This signal will appear 1170 kilocycles lower in frequency on the dial than the signal frequency, and it will be considerably weaker than the signal at resonance, therefore, it may be necessary to increase the output of the Signal Generator in order to identify the image signal.

4.34 The following general procedure should be employed in the alignment of the H.F. oscillator circuits of any frequency band.

- (1) Band 1—80 to 220 kilocycles.
 - (A) Set Signal Generator to 200 kilocycles.

MODEL RCH RADIO RECEIVING EQUIPMENT

- (B) Set receiver dial to 200 kilocycles.
 - (C) Adjust trimmer C-144 until maximum output is obtained on the output meter.
 - (D) Set Signal Generator to 90 kilocycles.
 - (E) Set receiver dial to 90 kilocycles.
 - (F) Adjust oscillator padder C-145 for maximum output.
 - (G) Set Signal Generator to 130 kilocycles.
 - (H) Set receiver dial to 130 kilocycles.
 - (I) Adjust inductance trimmer E-123 for maximum output.
 - (J) Repeat operations A to I inclusive, until the dial is correctly calibrated at all three frequencies.
- (2) Band 2—210 to 560 kilocycles.
- (A) Set Signal Generator to 500 kilocycles.
 - (B) Set receiver dial to 500 kilocycles.
 - (C) Adjust trimmer C-146 for maximum output.
 - (D) Set Signal Generator to 230 kilocycles.
 - (E) Set receiver dial to 230 kilocycles.
 - (F) Adjust padder C-147 for maximum output.
 - (G) Set Signal Generator to 330 kilocycles.
 - (H) Set receiver dial to 330 kilocycles.
 - (I) Adjust inductance trimmer E-124 for maximum output.
 - (J) Repeat A to I inclusive, until the dial calibration is correct at all three frequencies.
- (3) Band 3—1.9 to 5.1 megacycles.
- (A) Set Signal Generator to 4.7 megacycles.
 - (B) Set receiver dial to 4.7 megacycles.
 - (C) Adjust trimmer C-148 for maximum output.
 - (D) Set Signal Generator to 2.1 megacycles.
 - (E) Set receiver dial to 2.1 megacycles.
 - (F) Adjust inductance trimmer E-125 for maximum output.
 - (G) Repeat operations A to F inclusive until the dial calibration is correct.
- (4) Band 4—4.5 to 12 megacycles.
- (A) Set Signal Generator to 11 megacycles.
 - (B) Set receiver dial to 11 megacycles.
 - (C) Adjust trimmer C-149 for maximum output.
 - (D) Set Signal Generator to 5 megacycles.
 - (E) Set receiver dial to 5 megacycles.
 - (F) Adjust inductance trimmer E-126 for maximum output.
 - (G) Repeat operations A to F inclusive until the dial calibration is correct.
- (5) Band 5—8.8 to 24 megacycles.
- (A) Set Signal Generator to 24 megacycles.
 - (B) Set receiver dial to 24 megacycles.
 - (C) Adjust trimmer C-150 for maximum output.
 - (D) Set Signal Generator to 10 megacycles.
 - (E) Set receiver dial to 10 megacycles.
 - (F) Adjust inductance trimmer E-127 for maximum output.
 - (G) Repeat operations A to F inclusive until the dial calibration is correct.

4.4 R.F. AMPLIFIER ALIGNMENT

4.41 The following general procedure should be employed in the alignment of the R.F. and Antenna circuits.

- (1) Band 1—80 to 220 kilocycles.
- (A) Set Signal Generator to 200 kilocycles.
 - (B) Set receiver dial to 200 kilocycles.
 - (C) Adjust trimmer C-143 for maximum output. Antenna trimmer control E-109 should peak at approximately zero.
 - (D) Set Signal Generator to 90 kilocycles.
 - (E) Set receiver dial to 90 kilocycles.

- (F) Adjust inductance trimmers E-119 and E-115 for maximum output with the Antenna trimmer control E-109 set at zero.
- (G) Repeat operations A to F inclusive for final adjustment.
- (2) Band 2—210 to 560 kilocycles.
 - (A) Set Signal Generator to 500 kilocycles.
 - (B) Set receiver dial to 500 kilocycles.
 - (C) Adjust trimmer C-151 for maximum output.
 - (D) Set Signal Generator to 230 kilocycles.
 - (E) Set receiver dial to 230 kilocycles.
 - (F) Adjust inductance trimmers E-120 and E-116 for maximum output with the Antenna trimmer control E-109 set to zero.
 - (G) Repeat operations A to F inclusive for final adjustment.
- (3) Band 3—1.9 to 5.1 megacycles.
 - (A) Set Signal Generator to 5 megacycles.
 - (B) Set receiver dial to 5 megacycles.
 - (C) Adjust trimmer C-152 for maximum output.
 - (D) Set Signal Generator to 2.1 megacycles.
 - (E) Set receiver dial to 2.1 megacycles.
 - (F) Adjust inductance trimmers E-121 and E-117 for maximum output with the Antenna trimmer control E-109 set to zero.
 - (G) Repeat operations A to F inclusive for final adjustment.
- (4) Band 4—4.5 to 12 megacycles.
 - (A) Set Signal Generator to 11 megacycles.
 - (B) Set receiver dial to 11 megacycles.
 - (C) Adjust trimmers C-153 and C-142 for maximum output.
 - (D) Set Signal Generator to 5 megacycles.
 - (E) Set receiver dial to 5 megacycles.
 - (F) Adjust inductance trimmers E-122 and E-118 for maximum output.
 - (G) Repeat operations A to F inclusive for final adjustment.
- (5) Band 5—8.8 to 24 megacycles.
 - (A) Set Signal Generator to 24 megacycles.
 - (B) Set receiver dial to 24 megacycles.
 - (C) Adjust trimmers C-154 and C-141 for maximum output.
 - (D) Set Signal Generator to 10 megacycles.
 - (E) Set receiver dial to 10 megacycles.
 - (F) Adjust inductance trimmers E-140 and E-139 for maximum output.
 - (G) Repeat operations A to F inclusive for final adjustment.

5. OPERATING INSTRUCTIONS

5.1 All Switches and controls (with the exception of the main tuning control) of the type CZC-46209 Radio Receiver are identified by panel engraving.

5.2 The main tuning control knob E-114, is located at the right side of the panel, and is secured to a shaft which drives the ganged main tuning capacitors through a 25:1 ratio gear train. The dial calibration scale N-105 is secured to a shaft and driven by the same gear train so as to give 338 degrees rotation of the dial scale for 180 degrees rotation of the tuning capacitors. The dial calibration scale is directly calibrated in kilocycles on Bands 1 and 2, and in megacycles on Bands 3, 4 and 5. There is also a

logging scale on the outer circumference of the dial scale marked, 0 to 1000. The dial escutcheon E-137 is fitted with a transparent shatterproof lens, on which the five frequency bands are designated by engraved numbers. Indirect dial illumination is afforded by dial lamp I-101 mounted in back of the dial scale.

5.3 The GAIN control R-140 is located at the left bottom end of the panel, and consists of two controls ganged together. The outside section R-140B controls the gain of the R.F. amplifier tube V-101 and the first I.F. and second I.F. amplifier tubes V-104 and V-105, when the RECEPTION switch control is in the C.W. and C.W.O.L. positions. The inside section of the gain control R-140A

is used to control the input signal to the audio amplifier. This control is operated by knob E-108.

5.4 The ANTENNA TRIMMER control knob E-109 is located to the right of the GAIN control. This control is a variable air dielectric trimmer capacitor connected across the antenna section of the main tuning capacitor C-158. This control is used to compensate for variations in tracking which may occur when using different types of antennas. The control knob should be set at zero when tuning and adjusted for maximum gain when the desired signal is tuned in. This control is effective only on Bands 1, 2 and 3.

5.5 The PHONE JACK J-104 is located in the center of the panel to the right of the ANTENNA TRIMMER control. This jack is connected to the PHONE CONTROL switch operated by knob E-113, located in the upper left hand side of the panel. This control has three positions marked, No. 1, MIXED, No. 2. In No. 1 position the output of the Type CZC-46209 Radio Receiver is connected to the PHONE JACK. In MIXED position, the output of the Type CZC-46209 Radio Receiver and the output of a second receiver, attached to terminals E-103 in the rear of the chassis marked Set No. 2, are mixed so that the signals from both receivers are heard simultaneously. In No. 2 position the output of the second receiver only is connected to the PHONE JACK.

5.6 The BAND SELECTOR switch knob is located to the right of the PHONE JACK. This control operates to select the R.F. and H.F. oscillator circuits for the five frequency bands covered by the Type CZC-46209 Radio Receiver. The settings of this switch are marked 1, 2, 3, 4, 5 and they coincide with the markings on the dial escutcheon lens.

5.7 The C.W. OSC. control knob E-111 is located to the right of the BAND SELECTOR control. The C.W. OSC. control is effective only when the RECEPTION switch control is in the C.W. or C.W.O.L. positions. This control varies the frequency of the C.W. oscillator which tunes to the intermediate frequency of 585 kilocycles when the knob is set at ZERO. The best setting of the C.W. oscillator will depend upon operating conditions. When the received signal is free from interference and is sufficiently strong to override static and circuit noise it is recommended that the C.W. oscillator control be set at the I.F. frequency or zero. As the control is turned to either side of zero, the C.W. oscillator is detuned from the I.F. frequency of the receiver. The operator can determine the extent of this deviation by listening to the pitch of the background and circuit noises.

When the pitch of the beat note is 2000 or 3000 cycles, it will be found that the receiver has definite "single signal" properties such that one side of the audio beat note of a received signal will be considerably louder than the other side. This characteristic is helpful in receiving weak signals through interference and utilizes the maximum available sensitivity and selectivity of the receiver.

5.8 The RECEPTION control knob E-112 is located above the C.W. OSC. control. This control has three positions marked MOD., C.W., AND C.W.O.L. In the MOD. position the C.W. oscillator circuit is inoperative, the output limiter circuit is inoperative, the sensitivity section of the gain control is shorted out and the R.F. gain of the receiver is maximum at all times, the AVC circuit is operating and the receiver is in the correct operating condition for the reception of modulated signals. When the RECEPTION control is set to the C.W. position, the C.W. OSC. circuit is operating, the output limiter is off, the sensitivity section of the gain control is switched into the circuit so that the gain of the R.F., first and second I.F., amplifier tubes may be controlled, the AVC circuit is shorted out and the receiver is in the correct operating condition for the reception of C.W. signals. When the RECEPTION control is set to the C.W.O.L. position all circuits are adjusted as in the C.W. position with the exception of the output limiter circuit which is now switched into the circuit and by adjusting the OUTPUT LIMITER control R-137, the output level of the receiver can be adjusted so that on fading signals, the peaks are leveled off, keeping the audio signal at a more definite level.

5.9 The POWER switch S-104 is located in the center of the panel to the left of the dial escutcheon. This switch is connected in the power line input circuit and is provided to apply or remove line power to or from the complete equipment.

5.10 Directly above the main tuning control is located the DIAL LOCK control. When this control is turned clockwise it locks the main tuning control so that it cannot be jarred out of position from vibration. The DIAL LOCK is released by turning the knob counter-clockwise as far as necessary to allow the control to turn freely.

5.11 A screwdriver type control R-139 marked PHONE ADJ. is located on the left side of the receiver chassis. This control can be adjusted to raise or lower the audio output at the phone jack from 1 milliwatt to 100 milliwatts, with a 600 ohm speaker connected across the speaker terminal strip E-102.

5.12 A screwdriver type control R-138 marked NOISE LIMITER ADJ. is located on the right side of the receiver chassis. This control is provided to adjust the threshold level of the noise limiter circuit to the noise conditions aboard ship.

5.13 Terminal strips E-104 and E-105 located on the left side side of the receiver chassis are provided to select the proper impedance match for either 600 ohm or 20,000 ohm head phones. If 600 ohm phones are being used the link should be inserted in the 600 ohm strip. If 20,000 ohm phones are being used the link should be placed in the 20,000 ohm strip.

5.14 A set screw wrench for hollow head screws is furnished with each equipment. It is retained under two clips on the

front of the OSC. MIXER shield unit. This wrench can be used for removing all the control knobs, also for loosening the set screws holding the R.F. amplifier tube V-101. IF THIS TUBE IS REMOVED FOR SERVISING OR REPLACEMENT MAKE CERTAIN THAT THE THREE SCREWS HOLDING IT IN PLACE ARE SECURELY TIGHTENED AFTER REPLACING THE TUBE IN THE SOCKET.

5.15 Hand grips are provided on the front panel to aid in removing the chassis from the cabinet without subjecting any of the operating controls to any undue strain.

5.16 NEVER REPLACE THE LINE FUSES F-101 AND F-102 WITH FUSES OF HIGHER RATING THAN 2 AMPERES.

6. MAINTENANCE-FAILURES AND REMEDIES

6.1 GENERAL

6.11 Adequate test equipment for maintenance of Model RCH Radio Receiving Equipment should include the following items:

- (1) A Model LP Radio Frequency Standard Signal Generator, or equivalent.
- (2) An audio output meter, General Radio Co. Type 583A, or equivalent.
- (3) A Model OE Analyzer, or equivalent, for resistance measurements, testing vacuum tubes and measuring a-c and d-c potentials and currents in the circuits with which the tube under test is associated. The Performance and Test Data of Sections 2 and 6 may be determined with equipment as listed above.

6.12 In making any tests or adjustments, it is essential that the operator consider the influence that any one circuit element may have upon other associated circuits. The Test Data of Par. 6.4 will be particularly helpful in determining extent of such influences and the necessity for making further replacement after a fault in one particular circuit element has been located and repaired.

6.13 Any repairs in the Model RCH Radio Receiving Equipment which necessitate resoldering of joints should be made with care. The new joint should be such that the pieces to be soldered are firmly connected mechanically before solder is applied.

6.2 TUBE REPLACEMENT

6.21 ALL TUBES SUPPLIED WITH THE EQUIPMENT OR AS SPARES ON THE EQUIPMENT CONTRACT SHALL BE USED IN THE EQUIPMENT PRIOR

TO EMPLOYMENT OF TUBES FROM GENERAL STOCK.

6.22 Failure of a vacuum tube in the Receiver may reduce the sensitivity of the equipment to radio signals, produce intermittent operation or cause the equipment to be completely inoperative. In such cases all tubes should be checked either in an analyzer, or similar tube testing equipment, or by replacement with tubes of proven quality. When any tube is tested it should be tapped or jarred to make sure it has no internal loose connections or intermittent short-circuits.

6.23 When tube replacements become necessary, substitution of new tubes may alter alignment of r-f or i-f amplifier circuits, inasmuch as the replacement tubes may not be identical with those originally employed. The necessity for realignment as well as alignment procedure are discussed in Section 4.

6.3 FAILURE OF THE RADIO RECEIVER

6.31 In case of breakdown or failure of the Type CZC-46209 Radio Receiver, the fault must first be localized in one portion of the circuit. This can be accomplished by observation of some peculiar action of one of the controls or by checking the receiver against Test Data tabulated in Par. 6.4. Reference to Figures 2.13, 2.15, 2.111, will show the location of any component parts of the receiver. Functions and ratings of component parts are given in Parts List, Section 7.

6.32 It must be remembered that the Test Data of Section 6 will not positively locate certain faults. For instance, an open circuited bypass capacitor will not appear in point to point resistance tests and may intro-

duce regeneration or oscillation in certain circuits which effect the stage gain of other circuits. Similarly, a short circuit occurring in a low resistance inductor will not appear in point to point resistance tests and if the short appears in an R.F. coil, a false indication of the necessity for realignment may result.

6.33 By-pass or filter capacitors, which develop poor internal connections or which become open-circuited, will cause decreased sensitivity and/or poor stability. The defective unit can be generally located by temporarily connecting a good capacitor in parallel with each capacitor that is under suspicion.

6.34 Failures of any by-pass filter capacitor may seriously overload resistors of associated circuits. Overloads of sufficient magnitude to permanently damage a resistor will cause the painted surface of the resistor to be scorched, making the defective unit easy to locate by visual inspection.

6.35 Open, or short-circuited resistors can be definitely located by testing the resistance of each individual resistor. The schematic diagram Figure 2.2, should be consulted to make sure that any particular resistor under test is not connected in parallel with some other circuit element which might produce misleading measurements.

6.36 Loose connections, causing intermittent or noisy operation, and which cannot be found by point to point resistance tests, can usually be located by individually testing each circuit element, or by tapping or shaking the component, under suspicion, when the receiver is adjusted for normal operation.

6.37 The primary fuses F-101 and F-102 will "blow" when the primary circuit of transformer T-121, is subjected to a sustained primary current in excess of approximately two amperes.

6.4 TEST DATA

6.41 The TUBE SOCKET VOLTAGES AND CATHODE CURRENTS, Table 2 must not be considered as a list of the actual operational voltages and currents in the circuits of the Type CZC-46209 Radio Receiver. The resistance of the measuring instruments, together with capacitive and resistive loading effects, will disturb many of the circuits to such an extent that they become inoperative, thus altering normal voltage and current distribution.

6.42 The only currents listed in Table 2 are those in the various cathode circuits. This listing is a desirable simplification, inasmuch as measurements of cathode current constitutes a definite check on all circuits directly associated with the vacuum tube in question.

6.43 THE POINT TO POINT RESISTANCE Table 3 shows average resistance values in the Type CZC-46209 Radio Receiver with the speaker disconnected from terminals E-102 and head phones removed from jack J-104. The vacuum tubes need not be removed from their sockets. In using Table 2, the statements of paragraph 6.32 must be given consideration.

6.44 All measurements in Table 2 are made with the receiver connected for normal operation on a 115 volt, 60 cycle, single phase a-c source. The GAIN control should be adjusted for full clockwise rotation, and the PHONE CONTROL set at the "Set No. 1" position.

6.5 STAGE GAIN MEASUREMENTS

6.51 The sensitivity measurements, listed below, are made under the following conditions:

- (1) The Model RCH Radio Receiving Equipment is set up in accordance with paragraph 4.14. The standard signal generator is connected in accordance with paragraph 4.23, except that the high potential output lead is connected to the control grid of the tubes specified in Table 3.
- (2) Adjust the Standard Signal Generator for a test signal frequency of 585 kilocycles, modulated 30% at 400 cycles.
- (3) The GAIN control must be set at maximum (10), the RECEPTION control set at C.W. position, and the C.W. oscillator tube removed from its socket. The test signal should be within the limits specified below with 500 milliwatts output across a 600 ohm load at the speaker terminals E-102 since the output at the phone jack will depend on the setting of the variable resistor R-139.

Table 1

<i>Terminal</i>	<i>I.F. Sensitivity Microvolts</i>
V-103 Grid	52 uv ± 10 uv
V-104 Grid	1100 uv ± 200 uv
V-105 Grid	52000 uv ± 5000 uv

Table 2: TUBE SOCKET VOLTAGES AND CATHODE CURRENTS

Terminal	Pin	Variable		Voltages DC Volts	Currents DC MA
		Symbol	Setting		
V-101 Grid	cap	NONE		0	
Cathode	8	S-102	MOD	5.0	10.5
Cathode	8	S-102	C.W.		
		R-140B	0	32	1.5
		R-140B	10	5.0	10.5
Cathode	8	S-102	C.W.O.L.		
		R-140B	0	32	1.5
		R-140B	10	5.0	10.5
Screen	4	S-102	MOD	165	
Screen	4	S-102	C.W.		
		R-140B	0	210	
		R-140B	10	165	
Screen	4	S-102	C.W.O.L.		
		R-140B	0	210	
		R-140B	10	165	
Suppressor	5	S-102	MOD	165	
Suppressor	5	S-102	C.W.		
		R-140B	0	210	
		R-140B	10	165	
Suppressor	5	S-102	C.W.O.L.		
		R-140B	0	210	
		R-140B	10	165	
Plate	3	NONE		250	
V-102 Grid	5	NONE		0	
Cathode	8	NONE		0	7.0
Plate	3	NONE		135	
V-103 Grid #1	5	NONE		0	
Cathode	6	NONE		2.7	10.3
Grid #3	8	NONE		0	
Grid #5	1	NONE		0	
Grids #2 & 4	4	NONE		100	
Plate	3	NONE		250	
V-104 Grid	4	NONE		0	
Cathode	5	S-102	MOD	5.0	5.1
Cathode	5	S-102	C.W.		
		R-140B	0	35	
		R-140B	10	5.0	5.1
Cathode	5	S-102	C.W.O.L.		
		R-140B	0	35	
		R-140B	10	5.0	5.1
Screen	6	S-102	MOD	110	
Screen	6	S-102	C.W.		
		R-140B	0	175	
		R-140B	10	110	
Screen	6	S-102	C.W.O.L.		
		R-140B	0	175	
		R-140B	10	110	
Suppressor	3	NONE		0	
Plate	8	NONE		250	
V-105 Grid	4	NONE		0	
Cathode	5	S-102	MOD	3.5	6.1
Cathode	5	S-102	C.W.		
		R-140B	0	35	
		R-140B	10	3.5	6.1

Voltage measurements made with a DC Voltmeter, 20,000 ohms per volt. All voltage measurements made between socket terminals and Receiver chassis.

MODEL RCH RADIO RECEIVING EQUIPMENT

Table 2: TUBE SOCKET VOLTAGES AND CATHODE CURRENTS (Continued)

Terminal	Pin	Variable		Voltages DC Volts	Currents DC MA
		Symbol	Setting		
Cathode	5	S-102	C.W.O.L.		6.1
		R-140B	0	35	
		R-140B	10	3.5	
Screen	6	S-102	MOD	110	
Screen	6	S-102	C.W.		
Screen	6	R-140B	0	210	
		R-140B	10	110	
		S-102	C.W.O.L.		
Suppressor Plate	3 8	R-140B	0	210	
		R-140B	10	110	
		NONE		0	
V-106 Grid Cathode Screen Screen Screen Suppressor Plate Plate Plate	4 5 6 6 6 3 8 8 8	NONE		250	
		NONE		0	1.4
		S-102	MOD	0	
		S-102	C.W.	44	
		S-102	C.W.O.L.	44	
		NONE		0	
		S-102	MOD	0	
		S-102	C.W.	36	
		S-102	C.W.O.L.	36	
V-107 Cathode #1 Cathode #2 Plate #1 Plate #2	8 4 5 3	NONE		0	
		NONE		0	0
		NONE		0	
		NONE		0	
V-108 Triode Grid Triode Plate Cathode Diode plate #1 Diode plate #2	2 6 3 5 4	NONE		0	0.5
		NONE		120	
		NONE		1.0	
		NONE		3.0	
		NONE		3.0	
V-109 Cathode #1 Cathode #1 Cathode #1 Cathode #2 Plate #1 Plate #2	8 8 8 4 5 3	S-102	MOD	235	
		S-102	C.W.	235	
		S-102	C.W.O.L.	0	
		R-137	MAX	50	
		R-137	MIN		
		NONE		0	
		NONE		0	
		NONE		0	
V-110 Grid Cathode Screen Plate	5 8 4 3	NONE		0	24
		NONE		17	
		NONE		260	
		NONE		260	
V-111 Filament Filament Plate #1 Plate #2	2 8 6 4	NONE		280	
		NONE		280	
		NONE		250 AC	
		NONE		250 AC	

Voltage measurements made with a DC Voltmeter, 20,000 ohms per volt. All voltage measurements made between socket terminals and Receiver chassis.

MODEL RCH RADIO RECEIVING EQUIPMENT

Table 3: POINT TO POINT RESISTANCES
(Terminal to Chassis)

Terminal	Pin	Variable		Resistance (Ohms) Plus or Minus 10%	
		Symbol	Setting		
V-101	Grid	cap	S-102	MOD	1.41 Meg.
	Grid	cap	S-102	C.W.	0.47 Meg.
	Grid	cap	S-102	C.W.O.L.	0.47 Meg.
	Cathode	8	S-102	MOD	560
	Cathode	8	S-102	C.W.	8060
			R-140B	0	560
			R-140B	10	8060
			R-140B	10	560
	Cathode	8	S-102	C.W.O.L.	8060
			R-140B	0	560
	Screen	4	S-102	MOD	Infinite
			S-102	C.W.	Infinite
	Screen	4	S-102	C.W.O.L.	0.225 Meg.
	Suppressor	5	S-102	MOD	Infinite
	Suppressor	5	S-102	C.W.	Infinite
	Suppressor	5	S-102	C.W.O.L.	0.225 Meg.
	Plate	3	S-102	MOD	Infinite
	Plate	3	S-102	C.W.	Infinite
	Plate	3	S-102	C.W.O.L.	0.126 Meg.
	V-102	Grid	5	NONE	
Cathode		8	S-101	BAND #1	0.5
Cathode		8	S-101	BAND #2	0.9
Cathode		8	S-101	BAND #3	0.04
Cathode		8	S-101	BAND #4	0.023
Cathode		8	S-101	BAND #5	0.012
Plate		3	S-102	MOD	Infinite
Plate		3	S-102	C.W.	Infinite
Plate	3	S-102	C.W.O.L.	0.140 Meg.	
V-103	Grid #1	5	NONE		20000
	Cathode	6	NONE		270
	Grid #3	8	S-102	MOD	1.41 Meg
	Grid #3	8	S-102	C.W.	0.47 Meg.
	Grid #3	8	S-102	C.W.O.L.	0.47 Meg.
	Grid #5	1	NONE		0
	Grids #2 & 4	4	S-102	MOD	Infinite
	Grids #2 & 4	4	S-102	C.W.	Infinite
	Grids #2 & 4	4	S-102	C.W.O.L.	0.143 Meg.
	Plate	3	S-102	MOD	Infinite
	Plate	3	S-102	C.W.	Infinite
Plate	3	S-102	C.W.O.L.	0.126 Meg.	
V-104	Grid	4	S-102	MOD	1.16 Meg.
	Grid	4	S-102	C.W.	0.22 Meg.
	Grid	4	S-102	C.W.O.L.	0.22 Meg.
	Cathode	5	S-102	MOD	1000
	Cathode	5	S-102	C.W.	8500
			R-140B	0	1000
			R-140B	10	8500
			R-140B	10	1000
	Cathode	5	S-102	C.W.O.L.	8500
			R-140B	0	1000
	Screen	6	S-102	MOD	Infinite
	Screen	6	S-102	C.W.	Infinite
	Screen	6	S-102	C.W.O.L.	0.225 Meg.

MODEL RCH RADIO RECEIVING EQUIPMENT

Table 3: POINT TO POINT RESISTANCES (Continued)
(Terminal to Chassis)

Terminal	Pin	Variable		Resistance (Ohms) Plus or Minus 10%
		Symbol	Setting	
	3	NONE		0
	8	S-102	MOD	Infinite
	8	S-102	C.W.	Infinite
	8	S-102	C.W.O.L.	0.126 Meg.
V-105	4	S-102	MOD	1.16 Meg.
	4	S-102	C.W.	0.22 Meg
	4	S-102	C.W.O.L.	0.22 Meg
	5	S-102	MOD	560
	5	S-102	C.W.	
		R-140B	0	8060
		R-140B	10	560
	5	S-102	C.W.O.L.	
		R-140B	0	8060
		R-140B	10	560
	6	S-102	MOD	Infinite
	6	S-102	C.W.	Infinite
	6	S-102	C.W.O.L.	0.225 Meg.
	3	NONE		0
	8	S-102	MOD	Infinite
	8	S-102	C.W.	Infinite
	8	S-102	C.W.O.L.	0.126 Meg.
V-106	4	NONE		0.047 Meg.
	5	NONE		1.26
	6	S-102	MOD	Infinite
	6	S-102	C.W.	Infinite
	6	S-102	C.W.O.L.	0.445 Meg.
	3	NONE		0
	8	S-102	MOD	Infinite
	8	S-102	C.W.	Infinite
	8	S-102	C.W.O.L.	0.325 Meg.
V-107	8	R-138	MIN.	1.69 Meg.
		R-138	MAX.	1.44 Meg.
	4	NONE		0
	5	NONE		0.22 Meg.
	3	NONE		0.44 Meg.
V-108	2	R-140A	MIN.	0
		R-140A	MAX.	0.5 Meg
	3	NONE		2400
	6	S-102	MOD	Infinite
	6	S-102	C.W.	Infinite
	6	S-102	C.W.O.L.	0.392 Meg.
	4 & 5	S-102	MOD	0.47 Meg.
	4 & 5	S-102	C.W.	0.235 Meg.
	4 & 5	S-102	C.W.O.L.	0.235 Meg.
V-109	8	S-102	MOD	Infinite
	8	S-102	C.W.	Infinite
	8	S-102	C.W.O.L.	
		R-137	MIN.	0.025 Meg.
		R-137	MAX.	0

MODEL RCH RADIO RECEIVING EQUIPMENT

Table 3: POINT TO POINT RESISTANCES (Continued)
(Terminal to Chassis)

Terminal	Pin	Variable		Resistance (Ohms) Plus or Minus 10%
		Symbol	Setting	
Cathode #2	4	NONE		Infinite
Plate #1	5	NONE		Infinite
Plate #2	3	NONE		0
V-110 Grid	5	NONE		0.47 Meg.
Cathode	8	NONE		680
Screen	4	S-102	MOD	Infinite
Screen	4	S-102	C.W.	Infinite
Screen	4	S-102	C.W.O.L.	0.125 Meg.
Plate	3	S-103	#1	126,190
Plate	3	S-103	MIXED	126,190
Plate	3	S-103	#2	125,540
V-111 Filament	2 & 8	S-102	MOD	Infinite
Filament	2 & 8	S-102	C.W.	Infinite
Filament	2 & 8	S-102	C.W.O.L.	125,790
Plate #1	6	NONE		87.6
Plate #2	4	NONE		87.6

7. PARTS LISTS			
7.1 TABLE I			
LIST OF MAJOR UNITS			
FOR MODEL RCH RADIO RECEIVING EQUIPMENT			
<i>Symbol Group</i>	<i>Navy Type Designation</i>	<i>Name of Major Unit</i>	<i>Number Assembly Drawing</i>
101-199	CZC-46209	RADIO RECEIVER	

**7.2 TABLE II
PARTS LIST BY SYMBOL DESIGNATIONS
FOR MODEL RCH RADIO RECEIVING EQUIPMENT**

Symbol Desig.	FUNCTION	DESCRIPTION	Navy Type Number **	Navy Drawing or Spec.	MFR. MFR.	MFR. Desig.	Special Tolerance Rating or Modification	Contractor's Drawing and Part Number
CAPACITORS								
*C-101	Input filter	Capacitor, paper, 4MFD, 600 volts DC working	-481080	RE 48A 223B	9	7577A		5070
*C-102	Center filter	Same as C-101	-481080					
*C-103	Output filter	Same as C-101	-481080					
*C-104	V-108 plate filter	Same as C-101	-481080					
*C-105	V-101 cathode bypass	Capacitor, paper, 0.1/0.1/0.1 MFD each section, 600 volts DC working, hermetically sealed	-48713-B10	RE 48A 129F	9	7569		5065
C-105A	V-101 plate bypass							
C-105B	V-101 cathode bypass							
C-105C	V-101 screen bypass							
*C-106	V-103 cathode bypass	Same as C-105	-48713-B10					
C-106A	V-103 screen bypass							
C-106B	V-103 screen bypass							
C-106C	V-103 screen filter							
*C-107	V-102 heater bypass	Same as C-105	-48713-B10					
C-107A	V-102 plate bypass							
C-107B	V-102 plate bypass							
C-107C	V-102 plate filter							
*C-108	V-105 cathode bypass	Same as C-105	-48713-B10					
C-108A	V-105 screen bypass							
C-108B	V-105 screen bypass							
C-108C	V-105 plate filter							
*C-109	V-106 screen bypass	Same as C-105	-48713-B10					
C-109A	A.V.C. filter							
C-109B	Limiter bypass							
C-109C								
*C-110	V-103 plate filter	Capacitor, paper, 0.1/0.1 MFD. each section, 600 volts DC working	-48712-B10	RE 48A 129F	9	7574		5089
C-110A	V-104 grid filter							
C-110B								
*C-111	V-104 cathode bypass	Capacitor, paper, 0.05/0.05 MFD. each section, 600 volts DC working	-48315-B10	RE 48A 129F	9	7571		5067
C-111A	V-104 screen bypass							
C-111B								
*C-112	V-104 cathode bypass	Same as C-111	-48315-B10					
C-112A	V-104 screen bypass							
C-112B								
*C-113	V-104 plate filter	Same as C-111	-48315-B10					
C-113A	V-105 grid filter							
C-113B								

* Spare parts furnished. Refer to Table IV.

** In many cases the Navy Type Number listed is not the actual item supplied; however, this type will effect a suitable replacement.

7.2 TABLE II (Continued)
PARTS LIST BY SYMBOL DESIGNATIONS
FOR MODEL RCH RADIO RECEIVING EQUIPMENT

Symbol Desig.	FUNCTION	DESCRIPTION	Navy Type Number **	Navy Drawing or Spec.	MFR.	MFR. Desig.	Special Tolerance Rating or Modification	Contractor's Drawing and Part Number
CAPACITORS (Continued)								
*C-114	V-108 to V-109 coupling	Same as C-111	-48315-B10					
C-114A	V-109 to V-110 coupling	Same as C-111	-48315-B10					
*C-115	AC line bypass	Capacitor, paper, 0.02 MFD. 600 volts DC working	-48597-A10	RE 48A 129F	9	7570		5066
C-115A	AC line bypass	Capacitor, electrolytic, 25 MFD. 25 volts DC working		RE 13A 549A	9	5088		5088
*C-116	V-107 to V-108 coupling	Same as C-117						
*C-117	V-108 cathode bypass	Same as C-117						
*C-118	V-110 cathode bypass	Same as C-117						
*C-119	Minus 3 volt bypass	Capacitor, mica, 250 MMFD \pm 10%, 500 volts DC working	-48690-B10	RE 48A 154F RE 48A 148C	4	5WLS		5077
*C-120	V-101 grid coupling	Same as C-120	-48690-B10					
*C-121	V-103 grid coupling	Capacitor, mica, 50 MMFD \pm 10%, 500 volts DC working	-48895-B10	RE 48A 148C RE 48A 154F	4	5WLS		5076
*C-122	V-107 diode filter	Capacitor, silver mica, 5 MMFD. \pm 5%, 500 volts DC working			5	K5-5		7568
*C-123	V-106 plate to V-107 diode	Capacitor, silver mica, 3000 MMFD. \pm 5%, 500 volts DC working			4	1R		7137
*C-124	T-114 padder	Capacitor, silver mica, 1300 MMFD. \pm 5%, 500 volts DC working			4	1R		7726
*C-125	T-113 padder	Capacitor, silver mica, 175 MMFD. \pm 5%, 500 volts DC working			5	K175-5		7725
*C-126	T-112 padder	Capacitor, silver mica, 100 MMFD. \pm 5%, 500 volts DC working			5	K100-5		7133
*C-127	T-111 padder	Same as C-127						
*C-128	T-116 Pri. Tuning	Same as C-127						
*C-129	T-116 Sec. tuning	Same as C-127						
*C-130	T-117 Pri. tuning	Same as C-127						
*C-131	T-117 Sec. tuning	Same as C-127						
*C-132	T-118 Pri. tuning	Same as C-127						
*C-133	T-118 Sec. tuning	Same as C-127						
*C-134	T-119 tuning	Capacitor, silver ceramic, 100 MMFD. \pm 5%, pos. Temp. coefficient 120×10^{-6} mmf/mm $^{\circ}$ C, 500 volts DC working			5	P120E100		7682
*C-135	L-101 tuning	Same as C-127						

* Spare parts furnished. Refer to Table IV.

** In many cases the Navy Type Number listed is not the actual item supplied; however, this type will effect a suitable replacement.

7.2 TABLE II (Continued)
PARTS LIST BY SYMBOL DESIGNATIONS
FOR MODEL RCH RADIO RECEIVING EQUIPMENT

Symbol Desig.	FUNCTION	DESCRIPTION	Navy Type Number **	Navy Drawing or Spec.	MFR.	MFR. Desig.	Special Tolerance Rating or Modification	Contractor's Drawing and Part Number
CAPACITORS (Continued)								
*C-136	V-102 grid coupling	Capacitor, silver mica, 50 MMFD. \pm 5%, 500 volts DC working			5	K50-5		7132
*C-137	V-102 to V-103 coupling	Same as C-136						
*C-138	T-111 compensating	Capacitor, silver ceramic, 25 MMFD. \pm 5%, Neg. Temp. Coefficient 750x10 ⁻⁶ mmf/mm ² /°c, 500 volts DC working			5	N750K25		7681
*C-139	V-106 grid coupling	Same as C-136						
*C-140	V-105 plate to V-108 diode coupling	Same as C-136						
*C-141	T-105 trimmer	Capacitor, variable air. Min. capacity 4 MMFD. Max. capacity 50 MMFD.			3	5073		5073
*C-142	T-104 trimmer	Same as C-141						
*C-143	T-106 trimmer	Capacitor, variable air. Min. capacity 3 MMFD. Max. capacity 25 MMFD.			3	5072		5072
*C-144	T-111 trimmer	Same as C-141						
*C-145	T-111 var. padder	Same as C-141						
*C-146	T-112 trimmer	Same as C-141						
*C-147	T-112 padder	Same as C-141						
*C-148	T-113 trimmer	Same as C-141						
*C-149	T-114 trimmer	Same as C-141						
*C-150	T-115 trimmer	Same as C-143						
*C-151	T-107 trimmer	Same as C-141						
*C-152	T-108 trimmer	Same as C-143						
*C-153	T-109 trimmer	Same as C-143						
*C-154	T-110 trimmer	Same as C-141						
*C-155	T-119 trimmer	Capacitor, variable air. Min. capacity 2.8 MMFD. Max. capacity 18 MMFD.			3	7088		7088
*C-156	Antenna Sec. trimmer	Capacitor, variable air. Min. capacity 3.5 MMFD. Max. capacity 35 MMFD.			3	7567		7567
C-157		Capacitor, variable air two gang. Min. capacity 14 MMFD. Max. capacity 390 MMFD. 25 plates each section, Curve "C" 0.015 inches Min. spacing			14	80110		7076
C-157A	H.F. oscillator tuning	Capacitor, variable air. Min. capacity 14 MMFD. Max. capacity 390 MMFD.						
C-157B	R.F. tuning	25 plates, curve "C" 0.015 inches Min. spacing						
C-158	Antenna tuning	Capacitor, variable air. Min. capacity 14 MMFD. Max. capacity 390 MMFD.			14	80062		5100

* Spare parts furnished. Refer to Table IV.

** In many cases the Navy Type Number listed is not the actual item supplied; however, this type will effect a suitable replacement.

7.2 TABLE II (Continued)
PARTS LIST BY SYMBOL DESIGNATIONS
FOR MODEL RCH RADIO RECEIVING EQUIPMENT

Symbol Desig.	FUNCTION	DESCRIPTION	Navy Type Number **	Navy Drawing or Spec.	MFR.	MFR. Desig.	Special Tolerance Rating or Modification	Contractor's Drawing and Part Number
CAPACITORS (Continued)								
*C-159	R.F. bypass	Capacitor, mica, 3000 MMFD. \pm 10%, 500 volts DC working	-481037-10	RE 48A 143F	4	1WS		7688
*C-160	T-112 compensating	Capacitor, silver ceramic, 20 MMFD. \pm 5%, Neg. Temp. coefficient 750x10 ⁻⁶ MMF/MMF/ ^o c, 500 volts DC working		RE 48A 154F	5	N750K20		7680
*C-161	T-113 compensating	Same as C-160						
*C-162	T-114 compensating	Same as C-160						
*C-163	T-115 compensating	Same as C-160						
*C-164	T-107 Pri. shunt	Capacitor, mica, 20MMFD. \pm 10%, 500 volts DC working	-48895-B10	RE 48A 148C	4	5WLS		5075
*C-165	T-111 tuning	Same as C-136		RE 48A 154F				
*C-166	T-115 padder	Capacitor, silver mica, 8000 MMFD. \pm 5%, 300 volts DC working			4			7727

MISCELLANEOUS ELECTRICAL PARTS

E-101	V-101 grid connector	1/4" grid connector for octal tubes			11	Type 8		5045
E-102	Speaker output terminals, 600 ohms	Speaker output, two terminal strip marked 600 ohm SPKR.			8	6004		6004
E-103	Set #2 input terminals	Terminals for connection of set #2			8	7663		7663
E-104	Phone matching terminals	Phone matching, two terminal strip, marked 600 ohms			8	7671		7671
E-105	Phone matching terminals	Phone matching, two terminal strip, marked 20000 ohms			8	7672		7672
E-106	AC power receptacle	Two pole plug set in drawn metal shell for below surface mounting			2	61M10		7000
*E-107	Dial lamp socket	Bayonet type socket complete with connecting leads			18	7586		7586
E-108	Gain control knob	1 1/2" black bakelite knob			18	5119		5119
E-109	Ant. trimmer knob	Same as E-108						
E-110	Band change switch knob	Same as E-108						
E-111	C.W. Osc. knob	Same as E-108						
E-112	Reception switchknob	Same as E-108						
E-113	Phone control switch knob	Same as E-108						
E-114	Main tuning knob	2 1/2" black bakelite knob			18	5120		5120
E-115	T-101 inductance trimmer	Compressed powdered iron core coil inductance trimmer			16	5103		5103

* Spare parts furnished. Refer to Table IV.

** In many cases the Navy Type Number listed is not the actual item supplied; however, this type will effect a suitable replacement.

7.2 TABLE II (Continued)
PARTS LIST BY SYMBOL DESIGNATIONS
FOR MODEL RCH RADIO RECEIVING EQUIPMENT

Symbol Desig.	FUNCTION	DESCRIPTION	Navy Type Number **	Navy Drawing or Spec.	MFR.	MFR. Desig.	Special Tolerance Rating or Modification	Contractor's Drawing and Part Number
MISCELLANEOUS ELECTRICAL PARTS (Continued)								
E-116	T-102 inductance trimmer	Same as E-115						
E-117	T-103 inductance trimmer	Compressed powdered iron core coil inductance trimmer			16	5102		5102
E-118	T-104 inductance trimmer	Same as E-117						
E-119	T-106 inductance trimmer	Same as E-115						
E-120	T-107 inductance trimmer	Same as E-115						
E-121	T-108 inductance trimmer	Same as E-117						
E-122	T-109 inductance trimmer	Same as E-117						
E-123	T-111 inductance trimmer	Same as E-115						
E-124	T-112 inductance trimmer	Same as E-115						
E-125	T-113 inductance trimmer	Same as E-117						
E-126	T-114 inductance trimmer	Same as E-117						
E-127	T-115 inductance trimmer	Compressed powdered iron core coil inductance trimmer			16	7689		7689
E-128	T-116 Pri. inductance trimmer	Same as E-115						
E-129	T-116 Sec. inductance trimmer	Same as E-115						
E-130	T-117 Pri. inductance trimmer	Same as E-115						
E-131	T-117 Sec. inductance trimmer	Same as E-115						
E-132	T-118 Pri. inductance trimmer	Same as E-115						
E-133	T-118 Sec. inductance trimmer	Same as E-115						
E-134	T-119 inductance trimmer	Same as E-115						
E-135	L-101 inductance trimmer	Same as E-115						
E-136	Ground terminal	Screw type ground lug			8	11TAS		7011
E-137	Dial escutcheon	Bakelite dial escutcheon with shatter-proof lens			18	7072		7072
E-138	DC power switch receptacle	2 pole polarized plug set in drawn steel shell for below surface mounting			8	S-302-CCT		7228
E-139	T-105 inductance trimmer	Same as E-127						
E-140	T-110 inductance trimmer	Same as E-127						
FUSES								
*F-101	AC line fuse	Fuse, 2 amps. up to 250 V., cartridge type, 1 1/4 inches long, ferrules 1/4 inch dia.			10	1042 3AG		5111
*F-102	AC line fuse	Same as F-101						

* Spare parts furnished. Refer to Table IV.

** In many cases the Navy Type Number listed is not the actual item supplied; however, this type will effect a suitable replacement.

7.2 TABLE II (Continued)
PARTS LIST BY SYMBOL DESIGNATIONS
FOR MODEL RCH RADIO RECEIVING EQUIPMENT

Symbol Design.	FUNCTION	DESCRIPTION	Navy Type Number **	Navy Drawing or Spec.	MFR.	MFR. Desig.	Special Tolerance Rating or Modification	Contractor's Drawing and Part Number
HARDWARE								
H-101	O-101 to O-102 coupling	Metal coupling for 1/4" shaft			18	7573		7573
H-102	C-157 to C-158 coupling	Insulated coupling for 3/8" shaft			18	6081A		6081A
H-103	C-157 to main tuning dial coupling	Insulated coupling for 1/4" and 3/8" shafts			18	7572		7572
H-104	C-156 to O-103 coupling	Insulated coupling for 1/4 inch shaft			18	7638		7638
INDICATING DEVICES								
*I-101	Dial lighting lamp	Type 44 6.3 volt, 0.25 A			7	#44		5110
JACKS AND RECEPTACLES								
*J-101	Fuse holder	Extractor type fuse holder			10	1075		5112
J-102	Fuse holder	Same as J-101						
J-103	Concentric antenna jack	Concentric line jack for R.F. connections			12			7010
J-104	Phone jack	Jack, single, open circuit for two conductor plug with tip and sleeve only	-49120	RA 49F 215D	20	#501		5118
INDUCTORS R.F. & A.F.								
*L-101	Wave trap	Wave trap, 585 KC.190T, 7/41 litz wire, DC resistance 5.5 ohms ± 10%			18	7616		7616
*L-102	R.F. filter choke	Radio frequency choke, 2.1 M.H., 125 MA.DC. DC resistance 50 ohms ± 10%, pigtail terminals			11	R-100		5047
*L-103	Oscillator filter choke	Same as L-102			18	5046A		5046A
*L-104	V-102 heater filter choke	R.F. choke, 50T #24E wire, DC resistance 0.17 ohms ± 10%			19	T-47755		7085
*L-105	L.F. filter choke	Choke, 12 H, 80 MA ± 20%, test voltage 1500 RMS. 2850 T #32 E wire, DC resistance 250 ohms ± 10%			19	T-46788		5048
*L-106	L.F. filter choke	Choke, 32 H, 40 MA.DC ± 20%, test voltage 1500 RMS. 3900 T #34 E, DC resistance 540 ohms ± 10%						
NAMEPLATES, DIALS, CHARTS								
N-101	Model nameplate	Lithographed, plastic nameplate				7698		7698

* Spare parts furnished. Refer to Table IV.

** In many cases the Navy Type Number listed is not the actual item supplied; however, this type will effect a suitable replacement.

7.2 TABLE II (Continued)
PARTS LIST BY SYMBOL DESIGNATIONS
FOR MODEL RCH RADIO RECEIVING EQUIPMENT

Symbol Desig.	FUNCTION	DESCRIPTION	Navy Type Number **	Navy Drawing or Spec.	MFR.	MFR. Desig.	Special Tolerance Rating or Modification	Contractor's Drawing and Part Number
NAMEPLATES, DIALS, CHARTS (Continued)								
N-102	Noise limiter control nameplate	Etched zinc plate marked "Noise Limiter"			6	7661		7661
N-103	Output limiter control nameplate	Etched zinc plate marked "Output Limiter"			6	7662		7662
N-104	Phone output adjustment nameplate	Etched zinc plate marked "Phone Output Adj."			6	7660		7660
N-105	Dial calibration	Dial scale printed on "Insurok" disk			6	7728		7728
MECHANICAL PARTS, SHAFTS								
O-101	Band change switch shaft	Steel shaft, 1/4" x 11 5/16"			13	7551A		7551A
O-102	Band change shaft extension	Fibre shaft extension			18	7018		7018
O-103	Antenna trimmer shaft	Steel shaft, 1/4" x 13 1/16"			18	7641		7641
PLUGS								
P-101	Antenna connecting plug	Concentric plug for R.F. connection	-49121-A	RA 49F 216D	12			7009
P-102	AC power input plug	2 pole female connecting plug			2	61-F11		7006
RESISTORS								
*R-101	A.V.C. delay bias	Resistor, composition, 50 ohms ± 10%, 1 watt pigtail terminals	-63360	RE 13A 372G	17	SCI-1		7629
*R-102	V-103 cathode bias	Resistor, composition, 270 ohms ± 10%, 1/2 watt pigtail terminals	-63360	RE 13A 372G	17	SCI-1/2		7145
*R-103	V-101 cathode bias	Resistor, composition, 560 ohms ± 10%, 1/2 watt pigtail terminals	-63360	RE 13A 372G	17	SCI-1/2		7577
*R-104	V-105 cathode bias	Same as R-103						
*R-105	V-110 cathode bias	Resistor, composition, 680 ohms ± 10%, 2 watt, pigtail terminals	-63474	RE 13A 372G	17	SCI-2		7239
*R-106	V-103 plate filter	Resistor, composition, 1000 ohms ± 10%, 1/2 watt, pigtail terminals	-63360	RE 13A 372G	17	SCI-1/2		5136
*R-107	V-104 cathode bias	Same as R-106						
*R-108	V-104 plate filter	Same as R-106						
*R-109	V-105 plate filter	Same as R-106						
*R-110	V-108 cathode bias	Resistor, composition, 2400 ohms ± 10%, 1/2 watt, pigtail terminals	-63360	RE 13A 372G	17	SCI-1/2		7148

* Spare parts furnished. Refer to Table IV.

** In many cases the Navy Type Number listed is not the actual item supplied; however, this type will effect a suitable replacement.

7.2 TABLE II (Continued)
PARTS LIST BY SYMBOL DESIGNATIONS
FOR MODEL RCH RADIO RECEIVING EQUIPMENT

Symbol Desig.	FUNCTION	DESCRIPTION	Navy Type Number **	Navy Drawing or Spec.	MFR.	MFR. Desig.	Special Tolerance Rating or Modification	Contractor's Drawing and Part Number
RESISTORS (Continued)								
*R-111	Phone attenuator	Resistor, composition, 1500 ohms \pm 10%, $\frac{1}{2}$ watt, pigtail terminals	-63360	RE 13A 372G	17	SCI- $\frac{1}{2}$		5137
*R-112	V-102 plate filter	Resistor, composition, 15000 ohms \pm 10%, 2 watt, pigtail terminals	-63474	RE 13A 372G	17	SCI-2		7230
*R-113	V-103 screen filter	Resistor, composition, 18000 ohms \pm 10%, 2 watt, pigtail terminals	-63474	RE 13A 372G	17	SCI-2		7231
*R-114	V-103 grid #1, leak	Resistor, composition, 20000 ohms \pm 10%, $\frac{1}{2}$ watt, pigtail terminals	-63360	RE 13A 372G	17	SCI- $\frac{1}{2}$		7150
*R-115	V-101 plate filter	Same as R-106						
*R-116	V-102 grid leak	Resistor, composition, 47000 ohms \pm 10%, $\frac{1}{2}$ watt, pigtail terminals	-63360	RE 13A 372G	17	SCI- $\frac{1}{2}$		5141
*R-117	V-106 grid leak	Same as R-116						
*R-118	V-108 plate filter	Same as R-116						
*R-119	V-101 screen filter	Resistor, composition, 0.1 Meg. \pm 10%, $\frac{1}{2}$ watt, pigtail terminals	-63360	RE 13A 372G	17	SCI- $\frac{1}{2}$		5142
*R-120	V-104 screen filter	Same as R-119						
*R-121	V-105 screen filter	Same as R-119						
*R-122	V-106 plate load	Same as R-119						
*R-123	V-109 cathode bias	Same as R-119						
*R-124	V-106 screen filter	Same as R-119						
*R-125	V-104 grid filter	Resistor, composition, 0.22 Meg. \pm 10%, $\frac{1}{2}$ watt, pigtail terminals	-63360	RE 13A 372G	17	SCI- $\frac{1}{2}$		5144
*R-126	V-105 grid filter	Same as R-125						
*R-127	V-107 diode load	Same as R-125						
*R-128	V-108 plate load	Same as R-125						
*R-129	V-106 plate filter	Same as R-125						
*R-130	V-101 grid leak	Resistor, composition, 0.47 Meg. \pm 10%, $\frac{1}{2}$ watt, pigtail terminals	-63360	RE 13A 372G	17	SCI- $\frac{1}{2}$		5145
*R-131	V-103 grid leak	Same as R-130						
*R-132	V-108 diode load	Same as R-130						
*R-133	A.V.C. filter	Same as R-130						
*R-134	V-110 grid leak	Same as R-130						
*R-135	V-107 diode filter	Same as R-125						
*R-136	Noise limiter filter	Resistor, composition, 1.0 Meg. \pm 10%, $\frac{1}{2}$ watt, pigtail terminals	-63360	RE 13A 372G	17	SCI- $\frac{1}{2}$		5146
*R-137	Output limiter control	Potentiometer, composition, 25000 ohms \pm 20%, linear taper, screwdriver slot			16	7637		7637

* Spare parts furnished. Refer to Table IV.

** In many cases the Navy Type Number listed is not the actual item supplied; however, this type will effect a suitable replacement.

7.2 TABLE II (Continued)

PARTS LIST BY SYMBOL DESIGNATIONS
FOR MODEL RCH RADIO RECEIVING EQUIPMENT

Symbol Desig.	FUNCTION	DESCRIPTION	Navy Type Number **	Navy Drawing or Spec.	MFR.	MFR. Desig.	Special Tolerance Rating or Modification	Contractor's Drawing and Part Number
RESISTORS (Continued)								
*R-138	Noise limiter control	Potentiometer, composition, 0.25 Meg. \pm 20%, Semi-log clockwise taper, screw-driver slot			16	7620		7620
*R-139	Phone output control	Same as R-138						
*R-140	Audio gain control	Potentiometer, composition, Section A			16	7576		7576
R-140A		0.5 Meg. \pm 20%, semi-log clockwise taper. Section B 7500 ohms \pm 20%, log clockwise taper.						
R-140B	R.F. gain control							
R-141	Not used							
*R-142	Phone attenuator	Same as R-116						
*R-143	T-118 Sec. Shunt	Same as R-119						
SWITCHES								
*S-101	Antenna Pri. section	Band change switch, rotary type, 4 sections, 5 position, ceramic wafers			13	7551		7551
S-101A	Antenna Sec. section							
S-101B	R.F. section							
S-101C	Oscillator section							
S-101D	Reception switch							
*S-102	Phone control switch	Reception switch, rotary type, 1 section, 3 position, ceramic wafer			13	7552		7552
*S-103	Phone control switch	Phone control switch, rotary type, 1 section, 3 position, ceramic wafer			13	7659		7659
*S-104	AC on-off switch	Toggle switch, S.P.S.T. silver plated contacts, rated 3 amp, 250 volts DC	-24000	RE 24AA 118A	1			5197
TRANSFORMERS R.F., A.F. AND POWER								
*T-101	J-103 to V-101 coupling, Band #1	R.F. transformer assembly antenna section			18	7595		7595
*T-102	J-103 to V-101 coupling, Band #2	Pri. DC resistance 12.4 ohms \pm 10% Sec. DC resistance 44.5 ohms \pm 10% R.F. transformer assembly antenna section Pri. DC resistance 6.0 ohms \pm 10% Sec. DC resistance 15.7 ohms \pm 10%			18	7598 Pri 7599 Sec		Pri-7598 Sec-7599

* Spare parts furnished. Refer to Table IV.

** In many cases the Navy Type Number listed is not the actual item supplied; however, this type will effect a suitable replacement.

7.2 TABLE II (Continued)
PARTS LIST BY SYMBOL DESIGNATIONS
FOR MODEL RCH RADIO RECEIVING EQUIPMENT

Symbol Desig.	FUNCTION	DESCRIPTION	Navy Type Number **	Navy Drawing or Spec.	MFR.	MFR. Desig.	Special Tolerance Rating or Modification	Contractor's Drawing and Part Number
TRANSFORMERS R.F., A.F. AND POWER (Continued)								
*T-103	J-103 to V-101 coupling, Band #3	R.F. transformer assembly antenna section Pri. DC resistance 0.34 ohms ± 10% Sec. DC resistance 0.19 ohms ± 10%			18	7602 Pri 7603 Sec		Pri-7602 Sec-7603
*T-104	J-103 to V-101 coupling, Band #4	R.F. transformer assembly antenna section Pri. DC resistance 0.24 ohms ± 10% Sec. DC resistance 0.072 ohms ± 10%			18	7606 Pri 7607 Sec		Pri-7606 Sec-7607
*T-105	J-103 to V-101 coupling, Band #5	R.F. transformer assembly antenna section Pri. DC resistance 0.2 ohms ± 10% Sec. DC resistance 0.02 ohms ± 10%			18	7610 Pri 7611 Sec		Pri-7610 Sec-7611
*T-106	V-101 to V-103 coupling, Band #1	R.F. transformer assembly RF section Pri. DC resistance 25.9 ohms ± 10% Sec. DC resistance 45.4 ohms ± 10%			18	7596		7596
*T-107	V-101 to V-103 coupling, Band #2	R.F. transformer assembly RF section Pri. DC resistance 70.5 ohms ± 10% Sec. DC resistance 16.5 ohms ± 10%			18	7600		7600
*T-108	V-101 to V-103 coupling, Band #3	R.F. transformer assembly RF section Pri. DC resistance 0.12 ohms ± 10% Sec. DC resistance 0.19 ohms ± 10%			18	7604		7604
*T-109	V-101 to V-103 coupling, Band #4	R.F. transformer assembly RF section Pri. DC resistance 0.1 ohms ± 10% Sec. DC resistance 0.072 ohms ± 10%			18	7608		7608
*T-110	V-101 to V-103 coupling, Band #5	R.F. transformer assembly RF section Pri. DC resistance 0.02 ohms ± 10% Sec. DC resistance 0.02 ohms ± 10%			18	7612		7612
*T-111	Band #1 oscillator	R.F. transformer assembly oscillator section Tap DC resistance 0.5 ohms ± 10% Total DC resistance 4.5 ohms ± 10%			18	7597		7597
*T-112	Band #2 oscillator	R.F. transformer assembly oscillator section Tap DC resistance 0.9 ohms ± 10% Total DC resistance 5.1 ohms ± 10%			18	7601		7601

* Spare parts furnished. Refer to Table IV.

** In many cases the Navy Type Number listed is not the actual item supplied; however, this type will effect a suitable replacement.

7.2 TABLE II (Continued)
PARTS LIST BY SYMBOL DESIGNATIONS
FOR MODEL RCH RADIO RECEIVING EQUIPMENT

Symbol Desig.	FUNCTION	DESCRIPTION	Navy Type Number **	Navy Drawing or Spec.	MFR. Desig.	Special Tolerance Rating or Modification	Contractor's Drawing and Part Number
TRANSFORMERS R.F., A.F. AND POWER (Continued)							
*T-113	Band #3 oscillator	R.F. transformer assembly oscillator section Tap DC resistance 0.04 ohms \pm 10% Total DC resistance 0.13 ohms \pm 10%			18 7605		7605
*T-114	Band #4 oscillator	R.F. transformer assembly oscillator section Tap DC resistance 0.023 ohms \pm 10% Total DC resistance 0.07 ohms \pm 10%			18 7609		7609
*T-115	Band #5 oscillator	R.F. transformer assembly oscillator section Tap DC resistance 0.012 ohms \pm 10% Total DC resistance 0.038 ohms \pm 10%			18 7613		7613
*T-116	V-108 to V-104 coupling	No. 1 I.F. transformer, 585 KC. Pri. DC resistance 4.99 ohms \pm 10% Sec. DC resistance 5.1 ohms \pm 10%			18 7614		7614
*T-117	V-104 to V-105 coupling.	No. 2 I.F. transformer, 585 KC. Pri. DC resistance 5.5 ohms \pm 10% Sec. DC resistance 5.1 ohms \pm 10%			18 7615		7615
*T-118	V-105 to V-107 coupling	No. 3 I. F. transformer, 585 KC. Pri. DC resistance 4.99 ohms \pm 10% Sec. DC resistance 5.1 ohms \pm 10%			18 7675		7675
*T-119	C.W. Oscillator	C.W. Oscillator transformer Tap DC resistance 1.18 ohms \pm 10% Total coil DC resistance 7.82 ohms \pm 10%			18 7617		7617
*T-120	V-110 to speaker terminals coupling	Output transformer Pri. DC resistance 509 ohms \pm 10% No. 1 Sec. DC resistance 42.2 ohms \pm 10% No. 2 Sec. DC resistance 2570 ohms \pm 10%			19 T-47982	Pri. Impedance 8000 ohms \pm 20% at 400 cycles 40 MA.DC No. 1 Sec. 600 ohms \pm 20% No. 2 Sec. 20000 ohms \pm 20%	7693

* Spare parts furnished. Refer to Table IV.

** In many cases the Navy Type Number listed is not the actual item supplied; however, this type will effect a suitable replacement.

7.2 TABLE II (Continued)
PARTS LIST BY SYMBOL DESIGNATIONS
FOR MODEL RCH RADIO RECEIVING EQUIPMENT

Symbol Desig.	FUNCTION	DESCRIPTION	Navy Type Number **	Navy Drawing or Spec.	MFR.	MFR. Desig.	Special Tolerance Rating or Modification	Contractor's Drawing and Part Number
TRANSFORMERS R.F., A.F. AND POWER (Continued)								
*T-121	Power transformer	Pri. 82.5 VA. 115 volts, 0.71 Amps. \pm 10%, DC resistance 3.1 ohms \pm 10% No. 1 Sec. 255-255 volts, 80 MA.DC centertapped, total DC resistance 165.2 ohms \pm 10% No. 2 Sec. 6.3 volts, 3.8 amps. AC DC resistance 0.075 ohms \pm 10% No. 3 Sec. 5 volts, 4 amps. AC DC resistance 0.052 ohms \pm 10%			19	T-47901		7233
VACUUM TUBES								
*V-101	R.F. Amplifier	Vacuum tube (Receiving-Metal) Triple grid super-control amplifier. Base: small wafer octal 7 pin. miniature cap. Heater: Current 0.3 amps at 6.3 volts AC or DC.	-6K7	RE 13A 600E	15	6K7		6017
*V-102	H.F. Oscillator	Vacuum tube (Receiving-Metal) Detector amplifier triode. Base: Small wafer octal 6 pin, phenolic. Heater: Current 0.3 amps at 6.3 volts AC or DC	-6J5	RE 13A 600E	15	6J5		6015
*V-103	1st Detector mixer	Vacuum tube (Receiving-Metal) Pentagrid converter. Base: Small wafer octal 8 pin, phenolic. Heater: Current 0.3 amps at 6.3 volts AC or DC	-6SA7	RE 13A 600E	15	6SA7		6014
*V-104	1st I.F. amplifier	Vacuum tube (Receiving-Glass) Triple grid super-control amplifier. Base: Small wafer octal 8 pin. Heater: current 0.3 amps at 6.3 volts AC or DC Same as V-104	-6SK7GT	RE 13A 600E	15	6SK7GT		7165
*V-105	2nd I.F. amplifier	Vacuum tube (Receiving-Metal) Triple grid detector amplifier. Base: Small wafer octal 8 pin, phenolic. Heater: Current 0.3 amps at 6.3 volts AC or DC	-6SJ7	RE 13A 600E	15	6SJ7		6009
*V-106	C.W. Oscillator							

* Spare parts furnished. Refer to Table IV.

** In many cases the Navy Type Number listed is not the actual item supplied; however, this type will effect a suitable replacement.

7.2 TABLE II (Continued)
PARTS LIST BY SYMBOL DESIGNATIONS
FOR MODEL RCH RADIO RECEIVING EQUIPMENT

Symbol Desig.	FUNCTION	DESCRIPTION	Navy Type Number **	Navy Drawing or Spec.	MFR.	MFR. Desig.	Special Tolerance Rating or Modification	Contractor's Drawing and Part Number
VACUUM TUBES (Continued)								
*V-107	2nd Detector and noise limiter	Vacuum tube (Receiving-Glass) Twin diode. Base: Intermediate shell octal 7 pin Heater: Current 0.3 amps at 6.3 volts AC or DC	-6H6GT	RE 13A 600E	15	6H6GT		7167
*V-108	1st audio and A.V.C.	Vacuum tube (Receiving-Glass) Duplex diode high- μ triode. Base: Small wafer octal 8 pin. Heater: Current 0.3 amps at 6.3 volts AC or DC Same as V-107	-6SQ7GT	RE 13A 600E	15	6SQ7GT		7587
*V-109	Output limiter	Vacuum tube (Receiving-Glass) Beam power amplifier. Base: Intermediate shell octal 7 pin. Heater: Current 0.45 amps at 6.3 volts AC or DC	-6V6GT	RE 13A 600E	15	6V6GT		7153
*V-110	Power output amplifier							
*V-111	Rectifier	Vacuum tube (Receiving-Glass) Full wave high-vacuum rectifier. Base: Intermediate shell octal. Heater: Current 2 amps at 5 volts AC	-5Y3GT	RE 13A 600E	15	5Y3GT		7238
SOCKETS								
*X-101	Socket for V-101	Vacuum tube socket, eight contact octal, plug-in type, with retaining ring and spacer washer. Molded ceramic base. Circular	-49373	RE 49AA 313A	2	RSS8M		5175
*X-102	Socket for V-102	Same as X-101						
*X-103	Socket for V-103	Same as X-101						
*X-104	Socket for V-104	Same as X-101						
*X-105	Socket for V-105	Same as X-101						
*X-106	Socket for V-106	Same as X-101						
*X-107	Socket for V-107	Same as X-101						
*X-108	Socket for V-108	Same as X-101						
*X-109	Socket for V-109	Same as X-101						
*X-110	Socket for V-110	Same as X-101						
*X-111	Socket for V-111	Same as X-101						

* Spare parts furnished. Refer to Table IV.

** In many cases the Navy Type Number listed is not the actual item supplied; however, this type will effect a suitable replacement.

7.3 TABLE III
PARTS LIST BY NAVY TYPE NUMBERS
FOR MODEL RCH RADIO RECEIVING EQUIPMENT

Quantity	Navy Type Number	All Symbol Designations Involved	Quantity	Navy Type Number	All Symbol Designations Involved	Quantity	Navy Type Number	All Symbol Designations Involved	
MISCELLANEOUS Class 10									
1	E-101	E-101, E-102, E-103, E-104, E-105, E-106, E-107, E-108, E-109, E-110, E-111, E-112, E-113, E-114, E-115, E-116, E-119, E-120, E-123, E-124, E-128, E-129, E-130, E-131, E-132, E-133, E-134, E-135, E-117, E-118, E-121, E-122, E-125, E-126, E-127, E-139, E-140, E-136, E-137, E-138, H-101, H-102, H-103, H-104, I-101, N-101, N-102, N-103, N-104, N-105, N-106, N-107, O-101, O-102, O-103	1	-24000	S-104	1	L-104	R.F. INDUCTORS and CHOKES (Continued) Class 47	
1	E-102		1		S-101	1	T-101		
1	E-103		1		S-102	1	T-102		
1	E-104		1		S-103	1	T-103		
1	E-105				FUSES	1	T-104		
1	E-106		2		Class 28	1	T-105		
1	E-107				F-101, F-102	1	T-106		
6	E-108, E-109, E-110, E-111, E-112, E-113		TRANSFORMERS and A.F. INDUCTORS Class 30				1		T-107
1	E-114		1		L-105	1	T-108		
14	E-115, E-116, E-119, E-120, E-123, E-124, E-128, E-129, E-130, E-131, E-132, E-133, E-134, E-135		1		L-106	1	T-109		
6	E-117, E-118, E-121, E-122, E-125, E-126		1		T-120	1	T-110		
3	E-127, E-139, E-140		1		T-121	1	T-111		
1	E-136				VACUUM TUBES	1	T-112		
1	E-137		2		Class 38	1	T-113		
1	E-138	1		V-107, V-109	1	T-114			
1	H-101	1		V-102	1	T-115			
1	H-102	1		V-101	1	T-116			
1	H-103	1		V-110	1	T-117			
1	H-104	1		V-103	1	T-118			
1	I-101	1		V-106	1	T-119			
1	N-101	2		V-104, V-105	1				
1	N-102	1		V-108	1				
1	N-103	1		V-111	1				
1	N-104			R.F. INDUCTORS and CHOKES	1				
1	N-105	1		Class 47	1				
1	N-106	1		L-101	1				
1	N-107	2		L-102, L-103	1				
1	O-101				4				
1	O-102								
1	O-103								
CAPACITORS Class 48									
5	-48315	C-111, C-112, C-113, C-114	5	-48315	C-111, C-112, C-113, C-114	5	-48315	C-111, C-112, C-113, C-114	
1	-48597-A10	C-115	1	-48597-A10	C-115	1	-48597-A10	C-115	
2	-48690-B10	C-120, C-121	2	-48690-B10	C-120, C-121	2	-48690-B10	C-120, C-121	
1	-48712-B10	C-110	1	-48712-B10	C-110	1	-48712-B10	C-110	
5	-48713-B10	C-105, C-106, C-107, C-108, C-109	5	-48713-B10	C-105, C-106, C-107, C-108, C-109	5	-48713-B10	C-105, C-106, C-107, C-108, C-109	
1	-48895-B10	C-122	1	-48895-B10	C-122	1	-48895-B10	C-122	
1	-481036-D5	C-124	1	-481036-D5	C-124	1	-481036-D5	C-124	
1	-481037-10	C-159	1	-481037-10	C-159	1	-481037-10	C-159	
4	-481080	C-101, C-102, C-103, C-104	4	-481080	C-101, C-102, C-103, C-104	4	-481080	C-101, C-102, C-103, C-104	

7.3 TABLE III (Continued)
PARTS LIST BY NAVY TYPE NUMBERS
FOR MODEL RCH RADIO RECEIVING EQUIPMENT

Quantity	Navy Type Number	All Symbol Designations Involved	Quantity	Navy Type Number	All Symbol Designations Involved	Quantity	Navy Type Number	All Symbol Designations Involved
CAPACITORS (Continued) Class 48								
3		C-117, C-118, C-119	1	-63288	R-101			
1		C-123	1	-63360	R-102			
1		C-125	2	-63360	R-103, R-104			
1		C-126	1	-63705-10	R-105			
8		C-127, C-128, C-129, C-130, C-131, C-132, C-133, C-135	5	-63360	R-106, R-107, R-108, R-109 R-115			
5		C-136, C-137, C-139, C-140, C-165	1	-63360	R-110			
1		C-134	1	-63360	R-111			
1		C-138	1	-63474	R-112			
10		C-141, C-142, C-144, C-145 C-146, C-147, C-148, C-149, C-150, C-151	1	-63474	R-113			
4		C-143, C-152, C-153, C-154	1	-63360	R-114			
1		C-155	3	-63360	R-116, R-117, R-118			
1		C-156	7	-63360	R-119, R-120, R-121, R-122 R-123, R-124, R-143			
4		C-160, C-161, C-162, C-163	6	-63360	R-125, R-126, R-127, R-128 R-129, R-135			
1		C-166	5	-63360	R-130, R-131, R-132, R-133, R-134			
JACKS and PLUGS Class 49								
1	-49120	J-103	1		R-136			
1	-49121A	P-101	1		R-137			
2		J-101, J-102	2		R-138, R-139			
1		J-104	1		R-140			
1		P-102	1					
VACUUM TUBE SOCKETS Class 49								
11	-49373	X-101, X-102, X-103, X-104, X-105, X-106, X-107, X-108, X-109, X-110, X-111						

**7.4 TABLE IV
SPARE PARTS LIST BY NAVY TYPE NUMBERS
FOR MODEL RCH RADIO RECEIVING EQUIPMENT**

Quantity	Navy Type Number	All Symbol Designations Involved	Description	Navy Drawing or Spec.	MFR.	Mfr. Desig.	Special Tolerance Rating or Modification	Contractor's Drawing and Part Number
MISCELLANEOUS (Class 10)								
1	I-101		Type 44 Lamp, 6.3 volts, 0.25 amps, bayonet base		7	44		5110
1	J-101, J-102		Extractor Type fuse holder		10	1075		5112
44			Contacts for octal tube socket		2			5175A
SWITCHES (Class 24)								
1	-24000	S-104	Toggle switch, S.P.S.T. silver plated contacts, rated 3 amps, 250 volts DC	RE-244A118A	1			5197
1		S-101A	Switch, rotary type, 5 position, ceramic wafer, silver contacts		13			7551 #3
1		S-101B	Switch, rotary type, 5 position, ceramic wafer, silver contacts		13			7551 #2
1		S-101C	Switch, rotary type, 5 position, ceramic wafer, silver contacts		13			7551 #4
1		S-101D	Switch, rotary type, 5 position, ceramic wafer, silver contacts		13			7551 #1
1		S-102	Switch, rotary type, 3 position, ceramic wafer, silver contacts		13			7552
1		S-103	Switch, rotary type, 3 position, ceramic wafer, silver contacts		13			7659
FUSES (Class 28)								
3	F-101, F-102		Fuse, 2 amps, up to 250 volts, cartridge type, 1 1/4" long, ferrules 1/4" dia.		10	1042 3AG		5111
TRANSFORMERS and REACTORS (Class 30)								
1	T-121		Power transformer, Pri. 82.5 VA, 115 V, 0.71 amps., DC resistance 3.1 ohms ± 10%. Sec. #1, 255-255 volts, 80 MA DC ± 10%. Total DC resistance 165.2 ohms ± 10%. Sec. #2, 6.3 volts, 3.8 amps. DC resistance 0.075 ohms ± 10%. Sec. #3, 5 volts, 4 amps. DC resistance 0.052 ohms ± 10%		19	T-47901		7233

7.4 TABLE IV (Continued)
 SPARE PARTS LIST BY NAVY TYPE NUMBERS
 FOR MODEL RCH RADIO RECEIVING EQUIPMENT

Quantity	Navy Type Number	All Symbol Designations Involved	Description	Navy Drawing or Spec.	MFR.	Mfr. Desig.	Special Tolerance Rating or Modification	Contractor's Drawing and Part Number
TRANSFORMERS and REACTORS (Class 30) (Continued)								
1		T-120	Output transformer, pri. impedance 8000 ohms at 400 cycles \pm 20%, 40 ma. DC. DC resistance 509 ohms \pm 10%. Sec. #1, impedance 600 ohms \pm 20%, DC resistance 42.2 ohms \pm 10%. Sec. #2, impedance 20000 ohms \pm 20%. DC resistance 2570 ohms \pm 10% Filter choke, 12 H. 80 MA. DC. \pm 20%, DC resistance 250 ohms \pm 10% Filter choke, 32 H. 40 MA. DC. \pm 20%, DC resistance 540 ohms \pm 10%		19	T-47982		7693
1		L-105			19	T-47755		7085
1		L-106			19	T-46788		5048
VACUUM TUBES (Class 38)								
2	-6H6GT	V-107, V-109	Vacuum tube (receiving-glass) twin diode. Base: intermediate shell octal 7 pin. Heater: current 0.3 amps at 6.3 volts AC or DC		15	6H6GT		7167
1	-6J5	V-102	Vacuum tube, (receiving-metal) detector amplifier triode. Base: small wafer octal, 6 pin phenolic. Heater: current 0.3 amps at 6.3 volts AC or DC		15	6J5		6015
1	-6K7	V-101	Vacuum tube (receiving-metal) triple grid super control amplifier. Base: small wafer octal 7 pin, miniature cap. Heater: current 0.3 amps at 6.3 volts AC or DC		15	6K7		6017
1	-6SA7	V-103	Vacuum Tube (receiving-metal) pentagrid converter. Base: small wafer octal 8 pin phenolic. Heater: current 0.3 amps at 6.3 volts AC or DC		15	6SA7		6014
1	-6SJ7	V-106	Vacuum tube (receiving-metal) triple grid detector amplifier. Base: small wafer octal 8 pin phenolic. Heater: current 0.3 amps at 6.3 volts AC or DC		15	6SJ7		6009

**7.4 TABLE IV (Continued)
SPARE PARTS LIST BY NAVY TYPE NUMBERS
FOR MODEL RCH RADIO RECEIVING EQUIPMENT**

Quantity	Navy Type Number	All Symbol Designations Involved	Description	Navy Drawing or Spec.	MFR.	Mfr. Desig.	Special Tolerance Rating or Modification	Contractor's Drawing and Part Number
VACUUM TUBES (Class 38) (Continued)								
2	-6SK7GT	V-104, V-105	Vacuum tube (receiving-glass) triple grid super control amplifier. Base: small wafer octal 8 pin phenolic. Heater: current 0.3 amps at 6.3 volts AC or DC		15	6SK7GT		7165
1	-6SQ7GT	V-108	Vacuum tube (receiving-glass) twin diode and hi-mu triode. Base: small wafer octal 8 pin phenolic. Heater: current 0.3 amps at 6.3 volts AC or DC		15	6SQ7GT		7587
1	-6V6GT	V-110	Vacuum tube (receiving-glass) beam power amplifier. Base: intermediate shell octal 7 pin. Heater: current 0.45 amps at 6.3 volts AC or DC		15	6V6GT		7135
1	-5Y3GT	V-111	Vacuum tube (receiving-glass) full wave high vacuum rectifier. Base: intermediate shell octal 5 pin. Heater: current 2 amps at 5 volts AC		15	5Y3GT		7238
INDUCTORS and R.F. CHOKES (Class 47)								
1		L-101	Wave trap inductor, 585 KC. 470 uH 190 T #7/41 litz wire, DC resistance 5.5 ohms \pm 10%		18	7616		7616
1	-47122	L-102, L-103	R.F. choke, 2.1 MH. 125 MA DC DC resistance 50 ohms \pm 10%		11	R-100		5047
1		L-104	R.F. choke, 50 T #24 E wire DC resistance 0.17 ohms \pm 10%		18	5046		5046
1		T-101	R.F. transformer assembly, antenna section, band #1		18	7595		7595
1		T-102	R.F. transformer assembly, antenna section, band #2		18	7598		Pri-7598
1		T-103	R.F. transformer assembly, antenna section, band #3		18	7599		Sec-7599
1		T-104	R.F. transformer assembly, antenna section, band #4		18	7602		Pri-7602
1		T-105	R.F. transformer assembly, antenna section, band #5		18	7603		Sec-7603
1					18	7606		Pri-7606
1					18	7607		Sec-7607
1					18	7610		Pri-7610
1					18	7611		Sec-7611

7.4 TABLE IV (Continued)
 SPARE PARTS LIST BY NAVY TYPE NUMBERS
 FOR MODEL RCH RADIO RECEIVING EQUIPMENT

Quantity	Navy Type Number	All Symbol Designations Involved	Description	Navy Drawing or Spec.	MFR.	Mfr. Desig.	Special Tolerance Rating or Modification	Contractor's Drawing and Part Number
INDUCTORS and R.F. CHOKES (Class 47) (Continued)								
1	T-106		R. F. transformer assembly, R.F. section, band #1		18	7596		7596
1	T-107		R. F. transformer assembly, R.F. section, band #2		18	7600		7600
1	T-108		R. F. transformer assembly, R.F. section, band #3		18	7604		7604
1	T-109		R. F. transformer assembly, R.F. section, band #4		18	7608		7608
1	T-110		R. F. transformer assembly, R.F. section, band #5		18	7612		7612
1	T-111		R.F. transformer assembly, oscillator section, band #1		18	7597		7597
1	T-112		R.F. transformer assembly, oscillator section, band #2		18	7601		7601
1	T-113		R.F. transformer assembly, oscillator section, band #3		18	7605		7605
1	T-114		R.F. transformer assembly, oscillator section, band #4		18	7609		7609
1	T-115		R.F. transformer assembly, oscillator section, band #5		18	7613		7613
1	T-116		#1 I.F. transformer assembly, 585 KC.		18	7614		7614
1	T-117		#2 I.F. transformer assembly, 585 KC.		18	7615		7615
1	T-118		#3 I.F. transformer assembly, 585 KC.		18	7675		7675
1	T-119		B.F.O. transformer assembly, 585 KC.		18	7617		7617
CAPACITORS (Class 48)								
2	-481080	C-101, C-102, C-103, C-104	Capacitor, paper, 4 MFD. 600 volts DC working	RE-48A223B	9	7577A		5070
3	-48713-B10	C-105, C-106, C-107, C-108, C-109	Capacitor, paper, 0.1/0.1/0.1 MFD. each section 600 volts DC working, hermetically sealed	RE-48A129F	9	7569		5065
1	-48712-B10	C-110	Capacitor, paper, 0.1/0.1 MFD. each section 600 volts DC working, hermetically sealed	RE-48A129F	9	7574		5089
3	-48315-B10	C-111, C-112, C-113, C-114, C-115	Capacitor, paper, 0.05/0.05 MFD. each section 600 volts DC working, hermetically sealed	RE-48A129F	9	7571		5067

7.4 TABLE IV (Continued)
 SPARE PARTS LIST BY NAVY TYPE NUMBERS
 FOR MODEL RCH RADIO RECEIVING EQUIPMENT

Quantity	Navy Type Number	All Symbol Designations Involved	Description	Navy Drawing or Spec.	MFR.	Mfr. Desig.	Special Tolerance Rating or Modification	Contractor's Drawing and Part Number
CAPACITORS (Class 48) (Continued)								
1	-48597-A10	C-116	Capacitor, paper, 0.02 MFD. 600 volts DC working, hermetically sealed	RE-48A129F	9	7570		5066
2		C-117, C-118, C-119	Capacitor, electrolytic, 25 MFD. 25 volts DC working	RE-13A549A	9	5088		5088
1	-48690-B10	C-120, C-121	Capacitor, mica, 250 MMF. \pm 10%, 500 volts DC working	RE-48A148C RE-48A154F	4	5WLS		5077
1	-48895-B10	C-122	Capacitor, mica, 50 MMF. \pm 10%, 500 volts DC working	RE-48A148C RE-48A154F	4	5WLS		5076
1		C-123	Capacitor, silver mica, 5 MMF. \pm 5%, 500 volts DC working		5	K5-5		7568
1	-481036-D5	C-124	Capacitor, silver mica, 3000 MMF \pm 5%, 500 volts DC working	RE-48A143F	4	1R		7137
1		C-125	Capacitor, silver mica, 1300 MMF \pm 5%, 500 volts DC working	RE-48A154F	4	1R		7726
1		C-126	Capacitor, silver mica, 175 MMF. \pm 5%, 500 volts DC working		5	K175-5		7725
4		C-127, C-128, C-129, C-130, C-131, C-132, C-133, C-135	Capacitor, silver mica, 100 MMF. \pm 5%, 500 volts DC working		5	K100-5		7133
3		C-136, C-137, C-139, C-140, C-165	Capacitor, silver mica, 50 MMF. \pm 5%, 500 volts DC working		5	K50-5		7132
1		C-134	Capacitor, silver ceramic, 100 MMF. \pm 5%, temperature coefficient P120 x 10 ⁻⁶ MMF/MMF/ ^o c, 500 volts DC working		5	P120E100		7682
1		C-138	Capacitor, silver ceramic, 25 MMF. \pm 5%, temperature coefficient N750x10 ⁻⁶ MMF/MMF/ ^o c, 500 volts DC working		5	N750K25		7681
5		C-141, C-142, C-144, C-145 C-146, C-147, C-148, C-149, C-150, C-151	Capacitor, variable air, min. capacity 4 MMF, max. capacity 50 MMF.		3	5073		5073
2		C-143, C-152, C-153, C-154	Capacitor, variable air, min. capacity 3 MMF, max. capacity 25 MMF.		3	5072		5072
1		C-155	Capacitor, variable air, min. capacity 2.8 MMF, max. capacity 18 MMF.		3	7088		7088
1		C-156	Capacitor, variable air, min. capacity 3.5 MMF, max. capacity 35 MMF.		3	7567		7567

7.4 TABLE IV (Continued)
 SPARE PARTS LIST BY NAVY TYPE NUMBERS
 FOR MODEL RCH RADIO RECEIVING EQUIPMENT

Quantity	Navy Type Number	All Symbol Designations Involved	Description	Navy Drawing or Spec.	MFR.	Mfr. Desig.	Special Tolerance Rating or Modification	Contractor's Drawing and Part Number
CAPACITORS (Class 48) (Continued)								
1	-481037-10	C-159	Capacitor, mica, 3000 MMF. \pm 10%, 500 volts DC working	RE-48A143F	4	1WS		7688
2		C-160, C-161, C-162, C-163	Capacitor, silver ceramic, 20 MMF. \pm 5%, temperature coefficient N750x10-6 MMF/MMF/ $^{\circ}$ C, 500 volts DC working	RE-48A154F	5	N750K20		7680
1	-48895-B10	C-164	Capacitor, mica, 20 MMF \pm 10%, 500 volts DC working	RE-48A148C	4	5WLS		5075
1		C-166	Capacitor, silver mica, 8000 MMF \pm 5%, 300 volts DC working	RE-48A154F	4			7727
SOCKETS (Class 49)								
4	-49351	X-101, X-102, X-103, X-104, X-105, X-106, X-107, X-108, X-109, X-110, X-111,	Vacuum tube socket, eight contact octal, plug-in type with retaining ring and spacer washer. Molded mica filled bakelite base. Circular.	RE-49A313A	2	RS8TM		7035
1		E-107	Dial lamp socket, bayonet type for #44 lamp		18	7586		7586
RESISTORS (Class 63)								
1	-63288	R-101	Resistor, composition, 50 ohms, \pm 10%, 1 watt, pigtail terminals	RE-13A372G	17	SCI-1		7629
1	-63360	R-102	Resistor, composition, 270 ohms, \pm 10%, $\frac{1}{2}$ watt pigtail terminals	RE-13A372G	17	SCI- $\frac{1}{2}$		7145
1	-63360	R-103, R-104	Resistor, composition, 560 ohms \pm 10%, $\frac{1}{2}$ watt pigtail terminals	RE-13A372G	17	SCI- $\frac{1}{2}$		7577
1	-63705-10	R-105	Resistor, wirewound, 680 ohms \pm 10%, 2 watt, pigtail terminals, phenolic insulated	RE-13A372G	17	SCI-2		7239
3	-63360	R-106, R-107, R-108, R-109, R-115	Resistor, composition, 1000 ohms \pm 10%, $\frac{1}{2}$ watt pigtail terminals	RE-13A372G	17	SCI- $\frac{1}{2}$		5136
1	-63360	R-110	Resistor, composition, 2400 ohms \pm 10%, $\frac{1}{2}$ watt pigtail terminals	RE-13A372G	17	SCI- $\frac{1}{2}$		7148
1	-63360	R-111	Resistor, composition, 1500 ohms \pm 10%, $\frac{1}{2}$ watt pigtail terminals	RE-13A372G	17	SCI- $\frac{1}{2}$		5137

7.4 TABLE IV (Continued)
 SPARE PARTS LIST BY NAVY TYPE NUMBERS
 FOR MODEL RCH RADIO RECEIVING EQUIPMENT

Quantity	Navy Type Number	All Symbol Designations Involved	Description	Navy Drawing or Spec.	MFR.	Mfr. Desig.	Special Tolerance Rating or Modification	Contractor's Drawing and Part Number
RESISTORS (Class 68) (Continued)								
1	-63474	R-112	Resistor, composition, 15000 ohms, ± 10%, 2 watt pigtail terminals	RE-13A372G	17	SCI-2		7230
1	-63474	R-113	Resistor, composition, 18000 ohms ± 10%, 2 watt pigtail terminals	RE-13A372G	17	SCI-2		7231
1	-63360	R-114	Resistor, composition, 20000 ohms ± 10%, ½ watt pigtail terminals	RE-13A372G	17	SCI-½		7150
2	-63360	R-116, R-117, R-118	Resistor, composition, 47000 ohms ± 10%, ½ watt pigtail terminals	RE-13A372G	17	SCI-½		5141
3	-63360	R-119, R-120, R-121, R-122, R-123, R-124, R-143	Resistor, composition, 0.1 meg ± 10%, ½ watt pigtail terminals	RE-13A372G	17	SCI-½		5142
3	-63360	R-125, R-126, R-127, R-128, R-129, R-135	Resistor, composition, 0.22 meg ± 10%, ½ watt pigtail terminals	RE-13A372G	17	SCI-½		5144
3	-63360	R-130, R-131, R-132, R-133, R-134	Resistor, composition, 0.47 meg ± 10%, ½ watt pigtail terminals	RE-13A372G	17	SCI-½		5145
1	-63360	R-136	Resistor, composition, 1.0 meg ± 10%, ½ watt pigtail terminals	RE-13A372G	17	SCI-½		5146
1		R-137	Potentiometer, composition, 25000 ohms ± 20%, linear clockwise taper, screw-driver slot in shaft		16	7637		7637
1		R-138, R-139	Potentiometer, composition, 0.25 meg ± 20%, semi-log clockwise taper, screw-driver slot in shaft		16	7620		7620
1		R-140	Dual potentiometer, composition, section A, 0.5 meg. ± 20%, semi-log clockwise taper. Section B, 7500 ohms ± 20%, log clockwise taper		16	7656		7576

TABLE V
 APPLICABLE COLOR CODES AND MISCELLANEOUS DATA FOR MODEL RCH RADIO RECEIVING EQUIPMENT

Color Code in MMFD for Capacitors

Color	A 1st Digit	B 2nd Digit	C Ciphers
Black	—	0	.0
Brown	1	1	0
Red	2	2	00
Orange	3	3	000
Yellow	4	4	0000
Green	5	5	00000
Blue	6	6	000000
Purple	7	7	0000000
Gray	8	8	00000000
White	9	9	—

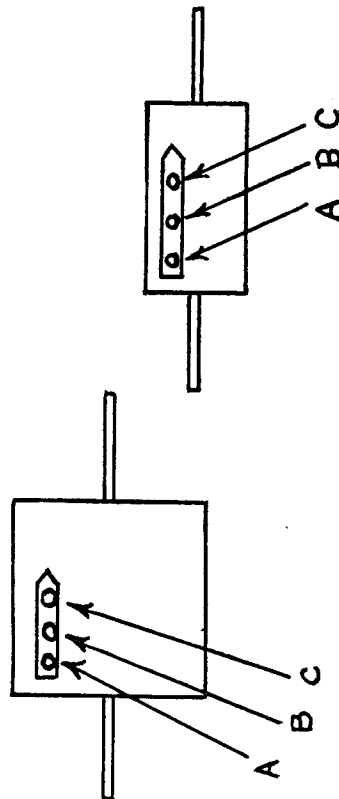

Silver mica capacitors have values stamped into body of condenser.

RMA Color Code for Resistors

Color	A 1st Digit	B 2nd Digit	C Ciphers
Black	—	0	.0
Brown	1	1	0
Red	2	2	00
Orange	3	3	000
Yellow	4	4	0000
Green	5	5	00000
Blue	6	6	000000
Purple	7	7	0000000
Gray	8	8	00000000
White	9	9	—

D—Tolerance Code:
 Gold—5% Silver—10%

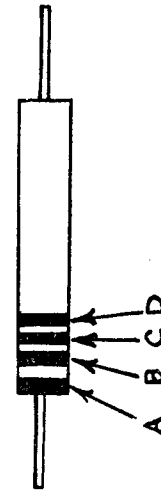

MODEL RCH RADIO RECEIVING EQUIPMENT

Table V
Applicable Color Codes and Miscellaneous Data for Model RCH Receiver

RMA 6 Dot Color Code
Read In Direction of Molded Arrow

<i>Color of Dot</i>	<i>Working Voltage</i>	<i>Significant Figure of Dot</i>	<i>Decimal Multiplier</i>	<i>Tolerance</i>
Black	0	1
Brown	100	1	10	1%
Red	200	2	100	2%
Orange	300	3	1000	3%
Yellow	400	4	4%
Green	500	5	5%
Blue	600	6	6%
Violet	700	7	7%
Gray	800	8	8%
White	900	9	9%
Gold	1000
Silver	2000	10%

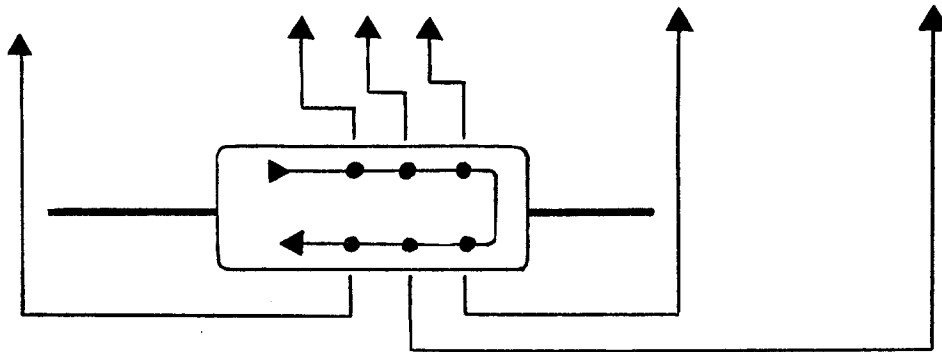

TABLE VI
LIST OF MANUFACTURERS FOR MODEL RCH RADIO RECEIVING EQUIPMENT

CODE No.	MFR. PREFIX	NAME	ADDRESS
1	CHH	Arrow Hart and Hegeman Electric Co.	Hartford, Connecticut
2	CPH	American Phenolic Corp.	1250 W. Van Buren St., Chicago, Ill.
3		Comar Electric Co.	3150 N. Washtenaw Ave., Chicago, Ill.
4	CD	Cornell-Dubilier Corp.	1000 Hamilton Blvd. So., Plainfield, N. J.
5	CER	Erie Resistor Corp.	Erie, Pennsylvania
6		Etching Co. of America	1520 Montana St., Chicago, Ill.
7	CG	General Electric Co.	Schenectady, N. Y.
8	CJC	Jones, Howard B.	2300 Wabansia Ave., Chicago, Ill.
9	CIE	Industrial Condenser Corp.	1725 W. North Ave., Chicago, Ill.
10	CLF	Littlefuse Labs.	4757 N. Ravenswood Ave., Chicago, Ill.
11	CNA	National Co.	Malden, Mass.
12	CN	National Electric Machine Shops, Inc.	1935 - 5th St. N. E., Washington, D. C.
13	COC	Oak Mfg. Co.	1260 N. Clybourn Ave., Chicago, Ill.
14	CRK	Radio Condenser Co.	Camden, New Jersey
15	CRV	RCA Mfg. Co.	(Radiotron Div.) Harrison, N. J.
16	CSA	Stackpole Carbon Co.	St. Mary's, Penn.
17	CPQ	Speer Resistor Co.	St. Mary's, Penn.
18	CZC	E. H. Scott Radio Labs., Inc.	4450 Ravenswood Ave., Chicago, Ill.
19	CTH	Thordarson Electric Mfg. Co.	500 W. Huron St., Chicago, Ill.
20	CRA	Utah Radio Products Co.	812 Orleans St., Chicago, Illinois